

Resource Identifier 100145

Revision: 19.0



# SOL07 Transmitter Family User Guide



Commercial in Confidence

# 0. Preface

## 0.1 About this Document

This document contains relevant information required to identify, install and control the equipment or system.

Since the available functions can be licensed and depend on the specific implementation, not all the functions and or applications contained in this document may be relevant or applicable to the system you will be working with.

The actual presentation may differ from those in this document due to hardware or software changes.

## 0.2 Intended Audience

This document is meant for anyone interested in how the system can be used, but it is of most benefit to:

- Operators who oversee the daily operation of the equipment
- Installers who are responsible for the pre-installation, on-site installation and configuration of the system in the end-user environment
- Maintainers who are responsible for maintaining the equipment or system

## 0.3 Notice about this Publication

While DTC makes every attempt to maintain the accuracy of the information contained in its product manuals, the information is subject to change without notice.

Performance specifications included in this manual are for guidance. All particulars are given by DTC in good faith, actual performance may vary.

## 0.4 Text Conventions

This document uses these conventions to identify text that has a special meaning:

Description	Example
TEXT in capitals represents a key press on the keyboard. The + sign means hold down the first key and press the second key.	ESC, F1, SHIFT CTRL+C
<Text> Serves as a placeholder for variable text that is replaced as appropriate, the text may be written in italics.	Use the filename <system_name>.sys for...
Text in italics can represent a link to place in the existing document (often these are hyperlinks) or a reference to another document.	Refer to <i>Section 0.4, Text Conventions</i> .
Text in bold emphasises a new word or term of significance.	We call this a <b>protocol</b> and its function is...
Successive software menu selections are shown using arrows to indicate sub-menus. This is often shown in bold.	Select <b>Configuration&gt;Global</b> then edit...

## 0.5 Symbols

This document uses these symbols to highlight important information:

**WARNING:** A notice of when a situation may result in personal injury or loss of life, or destruction of equipment.

**CAUTION:** A notice of when a situation may result in loss of data or damage to equipment or systems.

**Note:** A notice to draw attention to something or to supply additional information.

## 0.6 Copyright

This document contains information that is proprietary to Domo Tactical Communications (DTC) Ltd. Any copying or reproduction in any form whatsoever is prohibited without the written permission of DTC.

© 2013 Copyright Domo Tactical Communications (DTC) Limited. All rights reserved.

## 0.7 Related Documents

All DTC documents can be downloaded from WatchDox. See *Section 8.1*.

Document	Source
PRORXD Broadcast Receiver User Guide	DTC
SOL07 HD Receiver User Guide	DTC
SOL07 NanoVue HD Receiver User Guide	DTC

## 0.8 Document History

This is a controlled document, written and produced by the DTC Technical Publications team. Changes are recorded in the table below.

Revision	Date	Author	Summary of Changes
1.0	11/11/2013	RC	First release
8.0	31/10/2014	RC	FCC statement
9.0	14/12/2015	IR	Recommended video settings
10.0	22/02/2016	IR	Temperature control tips
11.0	22/06/2016	IR	OBTX and DTC rebrand
12.0	11/08/2016	IR	CA2253 assembly cautions
13.0	06/01/2017	IR	Upgrade procedures
14.0	11/05/2017	IR	Added SOL7TX
15.0	29/08/2017	IR	Added SOL7BNTX
16.0	10/10/2017	IR	Added remote commands and SOL7NAMP integration.
17.0	26/10/2017	IR	Customer logo on test pattern.
18.0	04/12/2017	IR	SOL7TX SDI/ASI In and LED metalwork change.
18.1	11/06/2018	IR	Added caution to command oprm and v1qm.
18.2	18/01/2019	IR	Clarified aircraft safety statement.
18.3	01/03/2019	IR	Dual pedestal, PES per frame.
18.4	16/03/2020	IR	New document layout. 5W and 2W amplifier options.
19.0	02/04/2020	IR	Updates for sw 3.4.0.

# Contents

<b>0. Preface.....</b>	<b>0-1</b>
0.1 About this Document .....	0-1
0.2 Intended Audience .....	0-1
0.3 Notice about this Publication.....	0-1
0.4 Text Conventions.....	0-2
0.5 Symbols .....	0-2
0.6 Copyright .....	0-2
0.7 Related Documents.....	0-3
0.8 Document History.....	0-3
<b>1. Product Overview.....</b>	<b>1-1</b>
1.1 Product Family .....	1-1
1.2 SOL07 Nano Transmitter.....	1-2
1.3 SOL07 HD Nano Transmitter .....	1-3
1.4 SOL07 Transmitter.....	1-4
1.5 SOL07 OB Transmitter .....	1-5
1.6 SOL07 Broadcast Nano Transmitter.....	1-6
1.7 Approval Notices .....	1-7
1.8 FCC Certification.....	1-7
<b>2. Product Package .....</b>	<b>2-8</b>
2.1 Packaging Overview.....	2-8
2.2 SOL07 Nano Transmitter.....	2-8
2.3 SOL07 HD Nano Transmitter .....	2-11
2.4 SOL07 Transmitter.....	2-14
2.5 SOL07 OB Transmitter .....	2-17
2.6 SOL07 Broadcast Nano Transmitter.....	2-21
<b>3. Controls, Connections and Indicators .....</b>	<b>3-24</b>
3.1 SOL07 Nano Transmitter.....	3-24
3.2 SOL07 HD Nano Transmitter .....	3-26
3.3 SOL07 Transmitter.....	3-28
3.4 SOL07 OB Transmitter .....	3-30
3.5 SOL07 Broadcast Nano Transmitter.....	3-32
<b>4. Getting Started.....</b>	<b>4-34</b>
4.1 Starting and Stopping the Transmitter .....	4-34
4.1 Domo Device Controller .....	4-34
4.2 Connecting your PC to the SOL07 Transmitter.....	4-35
4.3 Domo Device Controller Primary Window.....	4-37
4.4 Performing a Quick Setup .....	4-38
<b>5. Domo Device Controller Operation .....</b>	<b>5-40</b>

5.1	Introduction .....	5-40
5.2	Unit Status Panel.....	5-40
5.3	Switch Panel .....	5-42
5.4	Advanced>Unit Window.....	5-43
5.5	Advanced>Modulation Window.....	5-47
5.6	Advanced>Audio Window .....	5-52
5.7	Advanced>Video Window .....	5-55
5.8	Advanced>Misc Window .....	5-59
5.9	Licensing Upgrade .....	5-62
5.10	Firmware Upgrade – SOLO7 NTX/HDNTX/BNTX/TX.....	5-63
5.11	Firmware Upgrade – SOL7OBTX .....	5-64
5.12	Front Panel Interface Upgrade – SOL7OBTX.....	5-66
5.13	User Control Interface – SOL7OBTX only .....	5-69
<b>6.</b>	<b>Advanced Operation .....</b>	<b>6-73</b>
6.1	High Linearity and Low Power Modes .....	6-73
6.2	Domo Device Controller Logging Mode .....	6-75
6.3	Amplifier Integration.....	6-77
<b>7.</b>	<b>Appendix A – Reference Material.....</b>	<b>7-80</b>
7.1	Temperature Considerations.....	7-80
7.2	Pinout – SOL7NTX .....	7-81
7.3	Pinout – SOL7TX .....	7-83
7.4	Pinout – SOL7OBTX.....	7-84
7.5	Recommended Manual Video Encoder Settings .....	7-87
7.6	Install Device Drivers – SOL7OBTX .....	7-90
7.7	Remote Commands.....	7-94
<b>8.</b>	<b>Appendix B – After-Sales Support .....</b>	<b>8-109</b>
8.1	Documentation and Software.....	8-109
8.2	Contact Technical Support.....	8-109
8.3	Using the DTC RMA Service.....	8-109
<b>9.</b>	<b>Appendix C – Safety and Maintenance .....</b>	<b>9-111</b>
9.1	Cautions and Warnings .....	9-111
9.2	Repairs and Alterations .....	9-112
9.3	Caring for your Equipment .....	9-112
9.4	Charging.....	9-112
9.5	Working with Lithium Batteries.....	9-113
9.6	Cleaning .....	9-113
9.7	Storage .....	9-113
<b>10.</b>	<b>Appendix D – Glossary .....</b>	<b>10-114</b>

# 1. Product Overview

## 1.1 Product Family

The subject equipment of this user guide is:

<b>Equipment Title</b>	<b>Part Number</b>
SOL07 Nano Transmitter	SOL7NTX
SOL07 HD Nano Transmitter	SOL7HDNTX
SOL07 Transmitter	SOL7TX
SOL07 OB Transmitter	SOL7OBTX
SOL07 Broadcast Nano Transmitter	SOL7BNTX

## 1.2 SOL07 Nano Transmitter

### 1.2.1 Description



An ultra-miniature COFDM digital video transmitter designed specifically for when size, weight and power consumption are critical. Offering several user-selectable modes that trade off image quality against range, the SOL07 Nano Transmitter is ideal for battery powered applications requiring long term deployment, small unmanned aerial vehicles, body worn use or concealments.

### 1.2.2 Basic Specifications

<b>Size</b>	58mm (L) x 38mm (W) x 17mm (H)
<b>Weight</b>	51g
<b>Operating Temperature</b>	-10°C to +50°C
<b>Power Consumption</b>	Typically 3.7W @ 100mW RF
<b>DC Input</b>	5.9 to 17.8VDC reverse polarity protected



## 1.3 SOL07 HD Nano Transmitter

### 1.3.1 Description



The HD Nano Transmitter enables production teams to offer viewers stunning high definition images from the heart of the action, in situations never previously possible due to equipment size and battery run-time constraints.

The small size and ultra-low power consumption make the HD Nano TX ideal for a range of applications from Point of View links to UAV drone installations, enabling true long-range HD broadcasting from these increasingly popular devices for the first time. Optional lightweight, low power consumption amplifiers are also available for even greater range capability.

### 1.3.2 Basic Specifications

<b>Size</b>	67mm (L) x 68mm (W) x 22mm (H)
<b>Weight</b>	135g
<b>Operating Temperature</b>	-10°C to +50°C
<b>Power Consumption</b>	Typically 7.5W @ 100mW RF
<b>DC Input</b>	5.9 to 17.8VDC Reverse polarity protected

## 1.4 SOL07 Transmitter

### 1.4.1 Description



A miniature feature rich COFDM digital video transmitter designed specifically for situations when reliable operation and power consumption are critical. Offering several user-selectable modes allowing optimum selection of range and performance for flexibility in any environment. The SOL07 Transmitter is ideal for battery powered applications requiring long term deployment, unmanned aerial vehicles, body worn use or concealments.

The SOL07 Transmitter is highly power efficient drawing typically 3.7W and weighing only 116g making it ideal for indoor or outdoor deployments, used as a body worn application or mounted on any kind of vehicle, manned or unmanned, in any overt or covert application. Now even more capable with additional digital input for either SD-SDI cameras, or ASI for remux/relay applications.

### 1.4.2 Basic Specifications

<b>Size</b>	L 64mm, W 65mm, H 18mm
<b>Weight</b>	116g
<b>Operating Temperature</b>	-10°C to +50°C
<b>Power Consumption</b>	Typically 3.7W @ 100mW RF power with additional 2.0W for >6.0GHz down to 3.0W @ 10mW RF power
<b>DC Input</b>	5.9V to 17.8V reverse polarity protected

## 1.5 SOL07 OB Transmitter

### 1.5.1 Description



A compact and feature rich COFDM digital video transmitter, specifically designed for high quality wireless link applications. With proven Domo COFDM and H.264 encoder technology at its core enabling High Definition images the small size and ultra-low power consumption give maximum operational performance. Designed to offer maximum flexibility, the unit has a variety of video input options including composite, 3G-SDI and HDMI plus true balanced audio.

The transmitter has an integrated control panel with sunlight-readable OLED display covering all major functions and has 16 user-defined presets. A wide range of swappable frequency bands are available from 200MHz to 8.9GHz. Integrated UHF band Camera Control is available as an option.

### 1.5.2 Basic Specifications

<b>Size</b>	L 170mm (142mm excluding connectors) W 97mm (94mm excluding connectors) H 35mm (without battery plates) or H 71mm (with V-lock or PAG plates) or H 62mm (with Anton Bauer plates)
<b>Weight</b>	520g to 870g depending on options
<b>Operating Temperature</b>	-10°C to +50°C
<b>Power Consumption</b>	Typically 10.0W @ 100mW RF power with additional 2.0W for >6.0GHz.  Additional 0.5W for camera control.
<b>DC Input</b>	9.2V to 17.8V reverse polarity protected

## 1.6 SOL07 Broadcast Nano Transmitter

### 1.6.1 Description



The Broadcast Nano Transmitter is a development of the original Nano now incorporating a control panel, robust broadcast standard connectors and forced cooling, providing much improved thermal performance. It enables production teams to offer viewers stunning high definition images with ultra-low latency from the heart of the action, in situations not previously possible due to equipment size and battery run-time constraints.

The small size and ultra-low power consumption make the Broadcast Nano Transmitter ideal for a range of uses from Point of View and body worn applications such as live sports, live events, on-board motor sport applications and UAV drone installations, enabling true long range HD broadcasting from these increasingly popular applications for the first time. Optional lightweight, low power consumption amplifiers are also available for even greater range capability.

### 1.6.2 Basic Specifications

<b>Size</b>	L 76mm, W 60mm, H 23mm
<b>Weight</b>	139g
<b>Operating Temperature</b>	-10°C to +50°C
<b>Power Consumption</b>	Typically 5.0W to 8.0W @ 100mW RF power with additional 2.0W for >6.0GHz
<b>DC Input</b>	5.9V to 17.0V reverse polarity protected

## 1.7 Approval Notices

### 1.7.1 EMC/Safety and CE Marking

The equipment has been designed to meet and has been tested against harmonized EMC and safety standards. The CE mark is indicated on all SOL07 Transmitter product labels.

The CE Declaration of Conformity as well as the technical file are available on request.

## 1.8 FCC Certification

**Note:** Not currently applicable for OBTX.

### 1.8.1 FCC Subpart 15A Rule Section 15.21

**CAUTION:** The user of an intentional or unintentional radiator shall be aware that changes or modifications not expressly approved by DTC could void the user's authority to operate the equipment.

### 1.8.2 FCC Subpart 15B Rule Section 15.105

**Note:** This equipment has been tested and found to comply with the limits for a Class B digital device, pursuant to part 15 of the FCC Rules. These limits are designed to provide reasonable protection against harmful interference in a residential installation. This equipment generates, uses and can radiate radio frequency energy and, if not installed and used in accordance with the instructions, may cause harmful interference to radio communications. However, there is no guarantee that interference will not occur in a particular installation. If this equipment does cause harmful interference to radio or television reception, which can be determined by turning the equipment off and on, the user is encouraged to try to correct the interference by one or more of the following measures:

- Reorient or relocate the receiving antenna
- Increase the separation between the equipment and receiver
- Connect the equipment into an outlet on a circuit different from that to which the receiver is connected
- Consult the dealer or an experienced radio/TV technician for help

### 1.8.3 FCC Subpart 15A Rule Section 15.19(a) (3)

**Note:** This equipment has been tested and found to comply with the limits for a Class B digital device, pursuant to part 15 of the FCC Rules.

This device complies with part 15 of the FCC Rules. Operation is subject to the following two conditions: (1) This device may not cause harmful interference, and (2) this device must accept any interference received, including interference that may cause undesired operation.

### 1.8.4 RF Exposure Guidance

The unit must be operated at least 5mm away from the body for RF exposure compliance purposes.

## 2. Product Package

### 2.1 Packaging Overview

Verify that all the components have been included in the package as shown in the packing list. Retain the packing list and all the packing materials for storage.

The part numbers are useful for identification and if you need to order a new part. The codes in the packing list mean:

- CA – cable assembly
- SA – sub assembly
- AP – assembly part

**Note:** If you don't have all the parts or you are not happy with the condition of your delivered product, please call DTC and we'll get this solved for you. See *Section 8.2*.

### 2.2 SOL07 Nano Transmitter

#### 2.2.1 Parts List

Part Number	Description
SOL7NTX-xxxxxx	SOL07 Nano Transmitter, xxxxxx denotes frequency band
AP007377	USB A to micro USB B 1m cable
AP007619	BNC (f) to phono (m) adaptor
CA0002	12VDC power cable Lemo to banana plugs
CA2253	Power and control cable
CA2254	Audio, video and data cable

**CAUTION:** Newer revision CA2253 cables will have alignment marks to aid mating with the Omnetics Nano Circular 6-way receptacle on the NTX, however, the user must take great care when aligning the connectors and be aware that they are push-fit and must not be twisted.

## 2.2.2 Accessory Options

If you have purchased these options, they will also be in the package.

Part Number	Description
CA0001	RS232 control cable, Lemo to D-type
CA2250	Power cable
CA2298	9-way breakout cable
CA2370	Power and FCON cable
CA2485	6-way breakout power and RS232 cable
NTXBAT	Li-ion battery pack 7.4V, 2250mAh 4-pin Lemo
NTXBATCH	Battery charger for NTXBAT (multi-region).
*AMP2W-xxxxxx-OEM	2W PA OEM assembly non-bypass, xxxxxx denotes frequency band
*AMPD5W-xxxxxx-B-OEM	5W PA OEM assembly with bypass, xxxxxx denotes frequency band
*SOL7NAMP1W-xxxxxx	1W nano power amplifier, xxxxxx denotes frequency band.

\* See *Section 6.3* for integration details.

## 2.2.3 Variants

These are the current product offerings. The variant will be indicated on the product label.

Part Number	Description
SOL7NTX-020030	SOL07 Nano Transmitter 200-300MHz
SOL7NTX-030047	SOL07 Nano Transmitter 300-470MHz
SOL7NTX-045060	SOL07 Nano Transmitter 450-600MHz
SOL7NTX-100150	SOL07 Nano Transmitter 1.00-1.50GHz
SOL7NTX-165240	SOL07 Nano Transmitter 1.65-2.40GHz
SOL7NTX-198270	SOL07 Nano Transmitter 1.98-2.70GHz
SOL7NTX-300370	SOL07 Nano Transmitter 3.00-3.70GHz
SOL7NTX-440500	SOL07 Nano Transmitter 4.40-5.00GHz
SOL7NTX-550600	SOL07 Nano Transmitter 5.50-6.00GHz
SOL7NTX-640700	SOL07 Nano Transmitter 6.40-7.00GHz
SOL7NTX-700750	SOL07 Nano Transmitter 7.00-7.50GHz

## 2.2.4 Licensing Options

Licenses are programmed prior to shipment but can be upgraded.

Part Number	Description
Silver	DVB-T, Ultra Mobile Video Link (UMVL), MPEG-4 SD H.264, Dual Pedestal
Gold	Silver plus MPEG-4 ASP, 2.5MHz and 1.25MHz Modulation
Platinum	Gold plus 625kHz Modulation
AES128TX	AES 128-Bit Encryption
AES256TX	AES 256-Bit Encryption

## 2.2.5 Label

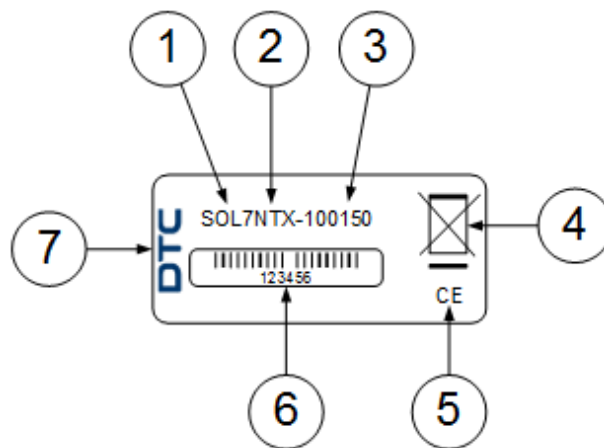

Item	Description
1	SOL07 product group
2	Nano Transmitter
3	Frequency range. In this example, 100150 denotes 1.00GHz to 1.50GHz.
4	Disposal mark
5	The CE mark certifies that a product has met EU consumer safety, health or environmental requirements.
6	Barcoded, six-digit serial number. This may be needed during a support call.
7	Manufacturer



## 2.3 SOLO7 HD Nano Transmitter

### 2.3.1 Parts List

Part Number	Description
SOL7HDNTX-xxxxxx	SOLO7 HD Nano Transmitter, xxxxxx denotes frequency band
AP007377	USB A to micro USB B 1m cable
AP007619	BNC (f) to phono (m) adaptor
AP009762	Micro HDMI (D) to HDMI (A) cable
CA0002	12VDC power cable Lemo to banana plugs
CA2253	Power and control cable
CA2254	Audio, video and data cable
CA2396	BNC (f) to DIN 1.0/2.3 RG179 cable

**CAUTION:** Newer revision CA2253 cables will have alignment marks to aid mating with the Omnetics Nano Circular 6-way receptacle on the NTX, however, the user must take great care when aligning the connectors and be aware that they are push-fit and must not be twisted.

### 2.3.2 Accessory Options

If you have purchased these options, they will also be in the package.

Part Number	Description
CA0001	RS232 control cable, Lemo to D-type
CA2250	Power cable
CA2298	9-way breakout cable
CA2370	Power and FCON cable
CA2485	6-way breakout power and RS232 cable
NTXBAT	Li-ion battery pack 7.4V, 2250mAh 4-pin Lemo
NTXBATCH	Battery charger for NTXBAT (multi-region).
*AMP2W-xxxxxx-OEM	2W PA OEM assembly non-bypass, xxxxxx denotes frequency band
*AMPD5W-xxxxxx-B-OEM	5W PA OEM assembly with bypass, xxxxxx denotes frequency band
*SOL7NAMP1W-xxxxxx	1W nano power amplifier, xxxxxx denotes frequency band.

\* See *Section 6.3* for integration details

### 2.3.3 Variants

These are the current product offerings. The variant will be indicated on the product label.

Part Number	Description
SOL7HDNTX-020030	SOL07 HD Nano Transmitter 200-300MHz
SOL7HDNTX-030047	SOL07 HD Nano Transmitter 300-470MHz
SOL7HDNTX-045060	SOL07 HD Nano Transmitter 450-600MHz
SOL7HDNTX-100150	SOL07 HD Nano Transmitter 1.00-1.50GHz
SOL7HDNTX-165240	SOL07 HD Nano Transmitter 1.65-2.40GHz
SOL7HDNTX-198270	SOL07 HD Nano Transmitter 1.98-2.70GHz
SOL7HDNTX-300370	SOL07 HD Nano Transmitter 3.00-3.70GHz
SOL7HDNTX-440500	SOL07 HD Nano Transmitter 4.40-5.00GHz
SOL7HDNTX-550600	SOL07 HD Nano Transmitter 5.50-6.00GHz
SOL7HDNTX-640700	SOL07 HD Nano Transmitter 6.40-7.00GHz
SOL7HDNTX-700750	SOL07 HD Nano Transmitter 7.00-7.50GHz
SOL7HDNTX-810890	SOL07 HD Nano Transmitter 8.10-8.90GHz

### 2.3.4 Licensing Options

Licenses are programmed prior to shipment but can be upgraded.

Part Number	Description
Silver	DVB-T, Ultra Mobile Video Link (UMVL), MPEG-4 SD H.264, Dual Pedestal and HD H.264
Gold	Silver plus MPEG-4 ASP, 2.5MHz and 1.25MHz Modulation
Platinum	Gold plus 625kHz Modulation and 4:2:2 H.264 Profile
AES128TX	AES 128-Bit Encryption
AES256TX	AES 256-Bit Encryption

### 2.3.5 Label

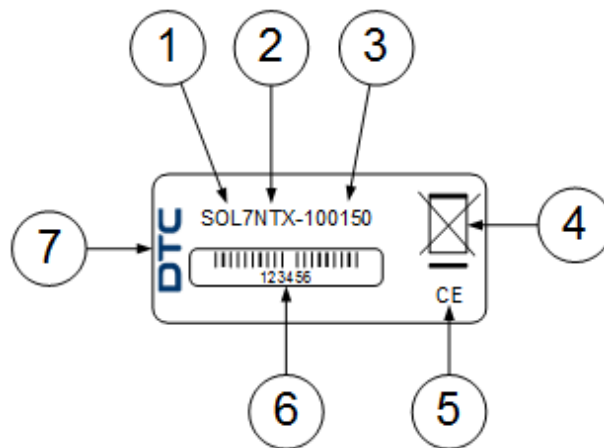

No	Description
1	SOL07 product group
2	Nano Transmitter family of products. This will be SOL7HDNTX.
3	Frequency range. In this example, 100150 denotes 1.00GHz to 1.50GHz.
4	Disposal mark.
5	The CE mark certifies that a product has met EU consumer safety, health or environmental requirements.
6	Barcoded, six-digit serial number. This may be needed during a support call.
7	Manufacturer.

## 2.4 SOL07 Transmitter

### 2.4.1 Parts List

Part Number	Description
SOL7TX-xxxxxx	SOL07 Transmitter, xxxxxx denotes frequency band.
AP007377	USB A to Micro USB B 1m cable
CA0002	12VDC power cable Lemo to banana plugs
CA3186	Hirose to power Lemo, video BNC(f) and audio 3.5mm jack cable

### 2.4.2 Accessory Options

If you have purchased these options, they will also be in the package.

Part Number	Description
CA0610	Hirose power and control cable
CA0611	Hirose power and video cable
CA0612	Hirose power, video and audio cable
CA3148	MCX 75Ω to BNC female cable
NTXBAT	Li-ion battery pack 7.4V, 2250mAh 4-pin Lemo
NTXBATCH	Battery charger for NTXBAT (multi-region).
*AMP2W-xxxxxx-OEM	2W PA OEM assembly non-bypass, xxxxxx denotes frequency band
*AMPD5W-xxxxxx-B-OEM	5W PA OEM assembly with bypass, xxxxxx denotes frequency band
*SOL7NAMP1W-xxxxxx	1W nano power amplifier, xxxxxx denotes frequency band.

\* See *Section 6.3* for integration details

### 2.4.3 Variants

These are the current product offerings. The variant will be indicated on the product label.

Part Number	Description
SOL7TX-020030	SOL07 Transmitter 200-300MHz
SOL7TX-030047	SOL07 Transmitter 300-470MHz
SOL7TX-045060	SOL07 Transmitter 450-600MHz
SOL7TX-100150	SOL07 Transmitter 1.00-1.50GHz
SOL7TX-165240	SOL07 Transmitter 1.65-2.40GHz
SOL7TX-198270	SOL07 Transmitter 1.98-2.70GHz
SOL7TX-300370	SOL07 Transmitter 3.00-3.70GHz
SOL7TX-440500	SOL07 Transmitter 4.40-5.00GHz
SOL7TX-550600	SOL07 Transmitter 5.50-6.00GHz
SOL7TX-640700	SOL07 Transmitter 6.40-7.00GHz
SOL7TX-700750	SOL07 Transmitter 7.00-7.50GHz
SOL7TX-810890	SOL07 Transmitter 8.10-8.90GHz

### 2.4.4 Licensing Options

Part Number	Description
Silver (included)	DVB-T, Ultra Mobile Video Link (UMVL), MPEG-4 SD H.264, Dual Pedestal
Gold	Silver plus MPEG-4 ASP, 2.5MHz and 1.25MHz Modulation
Platinum	Gold plus 625kHz Modulation
AES128TX	AES 128-Bit Encryption
AES256TX	AES 256-Bit Encryption

## 2.4.5 Label

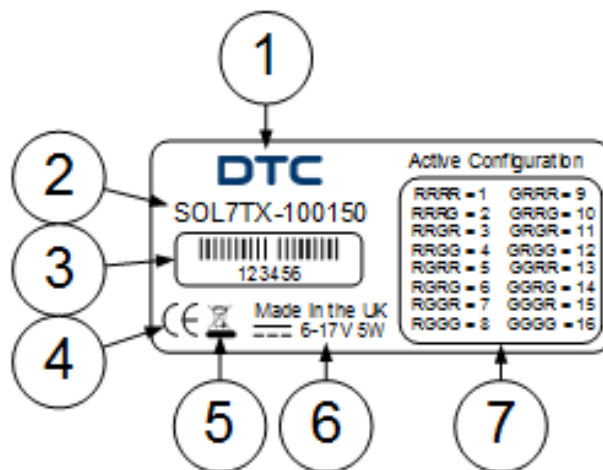

No	Description
1	Manufacturer
2	SOL7TX family of products with frequency range, in this example 100150 denotes 1.00GHz to 1.5GHz.
3	Barcoded, six-digit serial number. This may be needed during a support call.
4	The CE mark certifies that a product has met EU consumer safety, health or environmental requirements.
5	Disposal marking
6	Power requirement
7	LED sequence which indicates the active configuration. See <i>Section 3.3</i> .

## 2.5 SOL07 OB Transmitter

### 2.5.1 Parts List

Part Number	Description
SOL7OBTX-xxxxxx	SOL07 Outside Broadcast Transmitter, xxxxxx denotes frequency band
AP008822	433MHz telemetry antenna (CCCAM expansion option only)
CA0002	12VDC power cable Lemo to banana plugs
CA0343	USB control cable
CA0579	XLR audio cable

### 2.5.2 Accessory Options

If you have purchased these options, they will also be in the package.

Part Number	Description
OBTX-V-OEM	Additional V-Mount battery plates
OBTX-AB-OEM	Additional Anton Bauer battery plates
OBTX-PAG-OEM	Additional PAG battery plates
OBTX-xxxxxx-OEM	Additional RF module (where xxxxxx is the frequency band)
OBTX-CCCAM-RMA	Factory fit Camera Control RX upgrade. Also requires:
OBTX-CCCAM-ENABLE	Enable Camera control upgrade
OBTX-CCCAM-xUP	At least one control protocol and cable (see below options)
OBTX-CCCAM-SUP	Sony Control protocol and cable
OBTX-CCCAM-PUP	Panasonic Control protocol and cable
OBTX-CCCAM-TUP	Grass Valley Control protocol and cable
OBTX-CCCAM-IUP	Ikegami Control protocol and cable
OBTX-CCCAM-HUP	Hitachi Control protocol and cable
CA3122	Composite video input cable, Lemo to BNC
CA3232	RS232 data cable, Lemo to D-type

### 2.5.3 Variants

Part Number	Description
SOL70BTX-100150	SOL07 OB Transmitter 1.00-1.50GHz
SOL70BTX-198270	SOL07 OB Transmitter 1.98-2.70GHz
SOL70BTX-300370	SOL07 OB Transmitter 3.00-3.70GHz
SOL70BTX-440500	SOL07 OB Transmitter 4.40-5.00GHz
SOL70BTX-550600	SOL07 OB Transmitter 5.50-6.00GHz
SOL70BTX-640700	SOL07 OB Transmitter 6.40-7.00GHz
SOL70BTX-700750	SOL07 OB Transmitter 7.00-7.50GHz
SOL70BTX-810890	SOL07 OB Transmitter 8.10-8.90GHz

### 2.5.4 Licensing Options

Part Number	Description
Silver	DVB-T, Ultra Mobile Video Link (UMVL), MPEG-4 SD H.264, Dual Pedestal
Gold	Silver plus HD H.264
Platinum	Gold plus 4:2:2 H.264
Film Assist	2.5MHz Modulation and HD H.264 only
AES128TX	AES 128-Bit Encryption
AES256TX	AES 256-Bit Encryption



## 2.5.5 Labelling

### Product Label

The product label is situated on the rear panel of the OBTX. It identifies the OBTX assembly and has a different serial number to the RF Module.

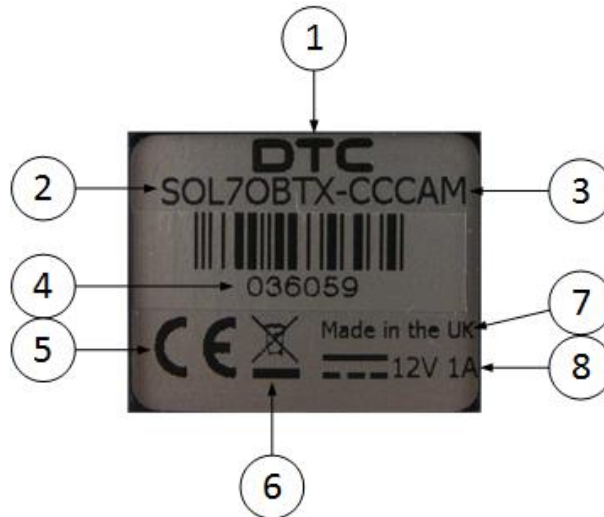

No	Description
1	Manufacturer
2	SOL07 OBTX family of products.
3	CCCAM expansion option in this example (if not fitted, this will be blank).
4	Barcoded, six-digit serial number. This may be needed during a support call.
5	The CE mark certifies that a product has met EU consumer safety, health or environmental requirements.
6	Disposal marking.
7	Country of manufacture.
8	Power requirement, 12VDC, 1A

## RF Module Label

The RF module label is situated in the left panel of the OBTX. It identifies the RF module and has a different serial number to the OBTX.

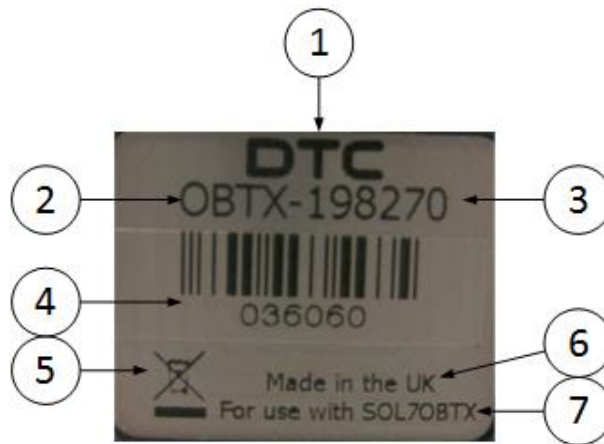

No	Description
1	Manufacturer
2	OBTX family of products.
3	Frequency range. In this example, 198270 denotes 1.98GHz to 2.70GHz.
4	Barcoded, six-digit serial number. This may be needed during a support call.
5	Disposal marking.
6	Country of manufacture.
7	Compatibility.

## 2.6 SOL07 Broadcast Nano Transmitter

### 2.6.1 Parts List

Part Number	Description
SOL7BNTX-xxxxxx	SOL07 Broadcast Nano Transmitter, xxxxxx denotes frequency band
AP007377	USB A to micro USB B cable
AP009762	Micro HDMI (D) to HDMI female (A) cable
CA0002	12VDC power cable Lemo to banana plugs
CA0579	XLR audio input cable
CA2396	BNC female to DIN 1.0/2.3 cable

### 2.6.2 Accessory Options

If you have purchased these options, they will also be in the package.

Part Number	Description
AP008399	Micro HDMI (D) male cable
SA4194	SOL7BNTX hot shoe mounting
NTXBAT	NTX 7.4V Battery Pack (2250mAh)
NTXBATCH	NTX Battery Charger (multi-region)
*AMP2W-xxxxxx-OEM	2W PA OEM assembly non-bypass, xxxxxx denotes frequency band
*AMPD5W-xxxxxx-B-OEM	5W PA OEM assembly with bypass, xxxxxx denotes frequency band
*SOL7NAMP1W-xxxxxx	1W nano power amplifier, xxxxxx denotes frequency band.

\* See *Section 6.3* for integration details

### 2.6.3 Variants

These are the current product offerings. The variant will be indicated on the product label.

Part Number	Equipment Title
SOL7BNTX-020030	SOL07 Broadcast Nano Transmitter 200-300MHz
SOL7BNTX-030047	SOL07 Broadcast Nano Transmitter 300-470MHz
SOL7BNTX-045060	SOL07 Broadcast Nano Transmitter 450-600MHz
SOL7BNTX-100150	SOL07 Broadcast Nano Transmitter 1.00-1.50GHz
SOL7BNTX-165240	SOL07 Broadcast Nano Transmitter 1.65-2.40GHz
SOL7BNTX-198270	SOL07 Broadcast Nano Transmitter 1.98-2.70GHz
SOL7BNTX-300370	SOL07 Broadcast Nano Transmitter 3.00-3.70GHz
SOL7BNTX-440500	SOL07 Broadcast Nano Transmitter 4.40-5.00GHz
SOL7BNTX-550600	SOL07 Broadcast Nano Transmitter 5.50-6.00GHz
SOL7BNTX-640700	SOL07 Broadcast Nano Transmitter 6.40-7.00GHz
SOL7BNTX-700750	SOL07 Broadcast Nano Transmitter 7.00-7.50GHz
SOL7BNTX-810890	SOL07 Broadcast Nano Transmitter 8.10-8.90GHz

### 2.6.4 Licensing Options

Part Number	Equipment Title
Silver	DVB-T, Ultra Mobile Video Link (UMVL), MPEG-4 SD H.264, Dual Pedestal
Gold	Silver plus HD H.264
Platinum	Gold plus 4:2:2 H.264
Film Assist	2.5MHz Modulation and HD H.264 only
AES128TX	AES 128-Bit Encryption
AES256TX	AES 256-Bit Encryption

## 2.6.5 Label

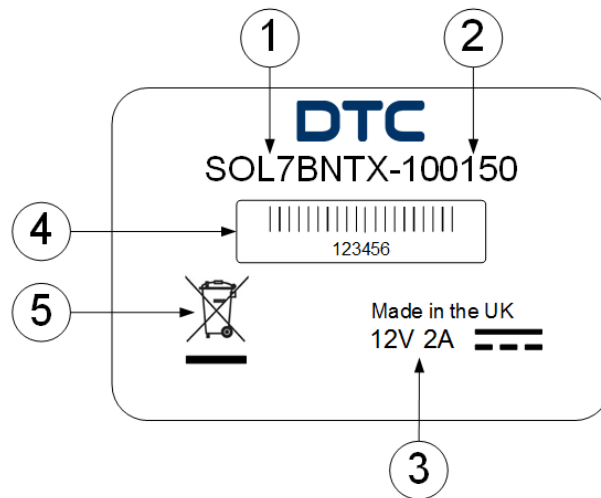

No	Description
1	SOL07 family of products.
2	Frequency range. In this example, 100150 denotes 1.00GHz to 1.50GHz.
3	Power requirements.
4	Barcoded six-digit serial number.
5	Disposal marking.

## 3. Controls, Connections and Indicators

### 3.1 SOL07 Nano Transmitter

#### 3.1.1 Top Panel



Item	Used for...
SMA jack (socket)	Connect the antenna to the SMA receptacle on the top panel of the transmitter unit. <b>CAUTION:</b> Do not over tighten the antenna – hand tight only!

#### 3.1.2 Bottom Panel

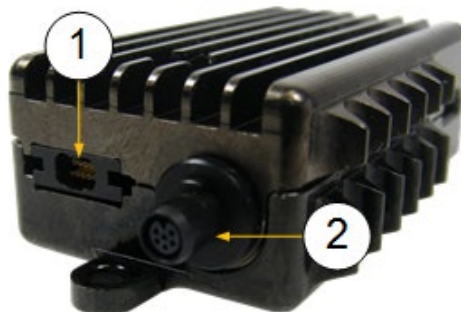

No	Item	Used for...
1	Omnetics Tri-Lobe Latching 9-way jack (sockets)	Video, audio left/right and data inputs. <b>Note:</b> Use CA2298 (option) 9-way breakout cable to access two video inputs: Composite video (only one at a time) Video 1: Composite 1 input Video 2: Composite 2 input S-Video: Video 1: S-Video luma input Video 2: S-Video chroma input

No	Item	Used for...
2	Omnetics Nano Circular 6-way jack (pins)	Power input and serial control port.

**CAUTION:** Newer revision CA2253 cables will have alignment marks to aid mating with the Omnetics Nano Circular 6-way receptacle on the NTX, however, the user must take great care when aligning the connectors and be aware that they are push-fit and must not be twisted.

### 3.1.3 Side Panel



Item	Used for...
USB Micro-B 4-way receptacle (socket)	USB control port for configuring unit.

## 3.2 SOLO7 HD Nano Transmitter

### 3.2.1 Top Panel



No	Item	Used for...
1	SMA receptacle (socket).	Connect the antenna to the SMA receptacle on the top panel of the transmitter unit. <b>CAUTION:</b> Do not over tighten the antenna – hand tight only!

### 3.2.2 Bottom Panel



No	Item	Used for...
1	DIN 1.0/2.3	SD/SD-SDI and ASI <b>Note:</b> Video input is configured in Domo Device Controller. This can be configured as either SDI or ASI but not both.
2	Micro HDMI Type-D	HDMI Input.



No	Item	Used for...
3	Omnetics Tri-Lobe Latching 9-way receptacle (socket).	Video, audio left/right and data inputs. <div style="border: 1px solid black; padding: 5px;"> <p><b>Note:</b> Use CA2298 (option) 9-way breakout cable to access two video inputs:</p> <p>Composite video (only one at a time)  Video 1: Composite 1 input  Video 2: Composite 2 input</p> <p>S-Video:  Video 1: S-Video luma input  Video 2: S-Video chroma input</p> </div>
4	Omnetics Nano Circular 6-way receptacle (pin).	Power input and serial control port.

**CAUTION:** Newer revision CA2253 cables will have alignment marks to aid mating with the Omnetics Nano Circular 6-way receptacle on the NTX, however, the user must take great care when aligning the connectors and be aware that they are push-fit and must not be twisted.

### 3.2.3 Side Panel



No	Item	Used for...
1	USB Micro-B 4-way receptacle (socket).	USB control port for configuring unit.

## 3.3 SOL07 Transmitter

### 3.3.1 Front Panel

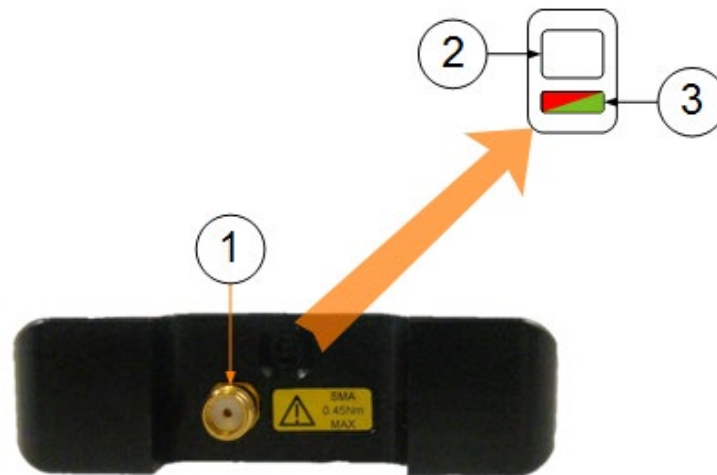

No	Item	Used for...
1	SMA receptacle (socket).	<p>Connect the antenna to the SMA receptacle on the top panel of the transmitter unit.</p> <p><b>CAUTION:</b> Do not over tighten the antenna – hand tight only!</p>
2	Config button	<p>The config button can be operated with a blunt but pointed tool. A ballpoint pen is ideal for this purpose.</p> <p>When you want to confirm the config that the SOL7TX is set to, press the config button once. The LEDs will flash accordingly.</p> <p>When you want to change the config, press and hold the config button until the red LED lights. The config will change incrementally, and the LEDs will flash accordingly.</p> <p><b>Note:</b> See the label on the top panel for the LED config sequence, refer to <i>Section 2.4.5</i>.</p>
3	Red/green dual colour LED	<p>The red LED is used to indicate the video input status:</p> <p>No light = video locked or off. Flash = video error.</p> <p>The green LED is used to indicate the RF input status:</p> <p>No light = RF off Solid ON = RF on</p> <p><b>Note:</b> The red/green LED is also used to indicate the config number that the SOL7TX is set to. See <b>Config button</b> above.</p>

### 3.3.2 Rear Panel

The rear panel will accommodate the supplied CA3186 to provide DC power (in conjunction with CA0002), video and audio inputs.

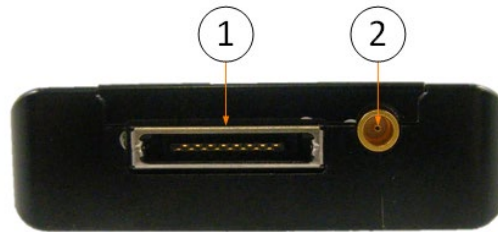

No	Item	Used for...
1	16-way Hirose 3500 series socket	Connect CA3186 here to provide DC power (in conjunction with CA0002), composite video and audio inputs. Data signals also provided are PA enable, RS232 control and chained data. Optional cables can be supplied.
2	MCX 75Ω socket	SD-SDI or ASI video input. The optional cable CA3148 will adapt the MCX connection to BNC.

### 3.3.3 Right Side Panel

On the right side panel there is a USB control port socket for configuring the unit using the Device Controller application. Connect the supplied AP007377 cable from the SOL7TX to a PC or laptop.



## 3.4 SOL07 OB Transmitter

### 3.4.1 Front Panel

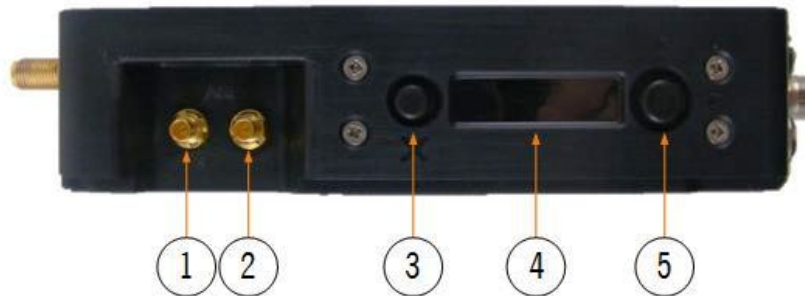

No	Item	Used for...
1	DIN 1.0/2.3 jack (pin)	ASI Out
2	DIN 1.0/2.3 jack (pin)	ASI In
3	Cancel/Back Button	User control interface
4	Display Screen	User control interface
5	Navigate/Confirm Button	User control interface

### 3.4.2 Rear Panel



No	Item	Used for...
1	Lemo 4-way jack (sockets)	Power amplifier – power and enable
2	HDMI type A receptacle	HDMI Video In

### 3.4.3 Left Panel

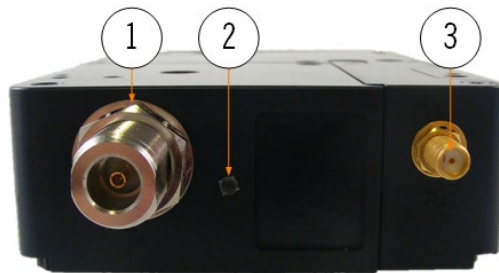

No	Item	Used for...
1	N-Type RF jack (socket)	RF power out
2	Light pipe indicator	RF Out/Video Status: Green = RF on, video locked No light = RF off, video locked Green/red flash = RF on, video error Red flash = RF off, video error
3	SMA jack (socket) – CCCAM only	CCCAM telemetry receive (403-474MHz)

### 3.4.4 Right Panel

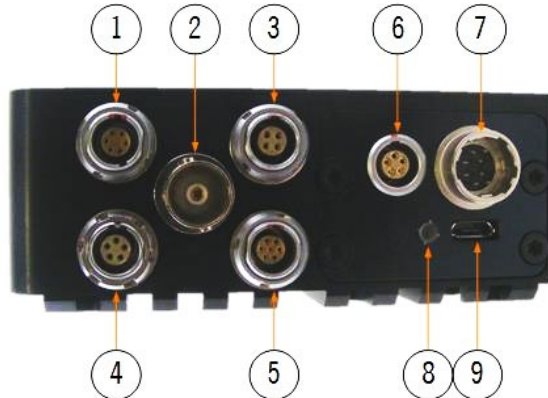

No	Item	Used for...
1	Lemo 6-way jack (sockets)	<b>CTRL</b> – RS232 communications to your PC
2	BNC jack (socket)	<b>SDI</b> – SDI video in
3	Lemo 4-way jack (sockets)	<b>PWR</b> – Power connector
4	Lemo 5-way jack (sockets)	<b>AUDIO</b> – Balanced audio connector
5	Lemo 7-way jack (socket)	<b>DATA CVBS</b> – Composite video and RS232 data
6	Lemo 5-way jack (sockets)	<b>CCCAM only</b> – Tally light control

No	Item	Used for...
7	Hirose 10-way jack (pins)	<b>CCCAM only</b> – Data and power to the camera.
8	Light pipe indicator	<b>CCCAM only</b> – Data receive indicator.
9	USB Micro-B 4-way jack (socket)	<b>CCCAM only</b> – This is for software updates.

## 3.5 SOL07 Broadcast Nano Transmitter

**Note:** The panel aspects are notionally described as front, rear, left and right.

### 3.5.1 Front Panel



On the front panel there is an SMA connector. Connect an antenna that matches the frequency bandwidth of the transmitter.

### 3.5.2 Rear Panel

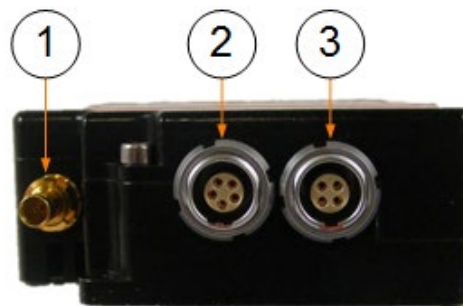

No	Item	Used for...
1	DIN 1.0/2.3	SD/HD-SDI and ASI video input. The supplied CA2396 cable will adapt this to BNC.
2	5-way Lemo socket	Connect the supplied CA0579 here for a balanced audio input.
3	4-way Lemo socket	Connect DC power with the supplied CA0002 cable.

### 3.5.3 Left Panel

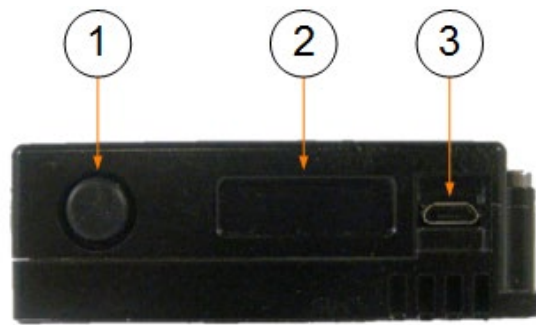

No	Item	Used for...
1	Navigation button	Use the navigation button to select the SOL7BNTX menu structure. Push right or left to go up or down a level in the menu. Push up or down to select different menus or to select a new value.
2	Display screen	The user control interface.
3	USB micro-B	The USB port is for configuring the unit using the Device Controller application. Connect the supplied AP007377 cable from the SOL7TX to a PC or laptop.

### 3.5.4 Right Panel



On the right panel there is a type D (micro) HDMI video port. The supplied CA2152 cable will adapt to type A (standard) HDMI.

## 4. Getting Started

### 4.1 Starting and Stopping the Transmitter

SOLO7 Transmitters units don't have power switches, they are powered up and down directly from the power source. Before shutting down, ensure the unit is not in sleep mode.

### 4.1 Domo Device Controller

#### 4.1.1 Introduction

Domo Device Controller provides users with convenient access to the most usual features and functions of the device. Domo Device Controller allows you to set up to sixteen presets and have control of all parameters of the unit.

**Note:** The HD transmitters will have some different options to the SD transmitters.



#### 4.1.2 Install the Controller on your PC

Domo Device Controller comes as an executable installer package.

**Note:** You can download the latest version from the DTC's Watchdox facility, see *Section 8.1*.

Double-click the executable to install this software on your PC.

A desktop icon will appear on your desktop.





## 4.2 Connecting your PC to the SOL07 Transmitter

Ensure your transmitter is connected by either USB or serial control and is powered up.

**Note:** If using an OBTX for the first time, you may need to install drivers to enable the Com Port. See *Section 7.6*. You will need to establish the Com Port that has been created for the OBTX from your PC's Device Manager.

Double-click Domo Device Controller icon on the computer desktop to open the Domo Device Controller. Click the connection button.



Select **USB** or **Serial Port** in the device connection window (dependent on your device connection). You'll see the **USB** identification number or serial port **Com Port** of the Transmitter.

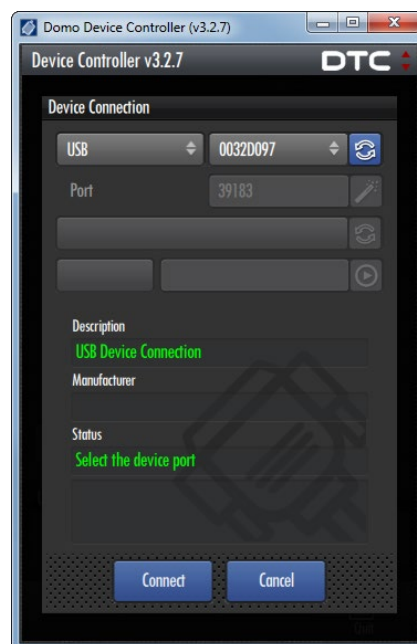

Click the **Connect** button. Device Controller reads the SOLO7 Transmitter configurations and the primary window opens.

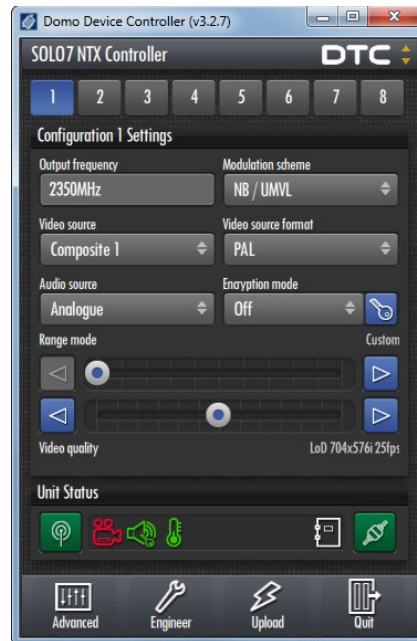

## 4.3 Domo Device Controller Primary Window

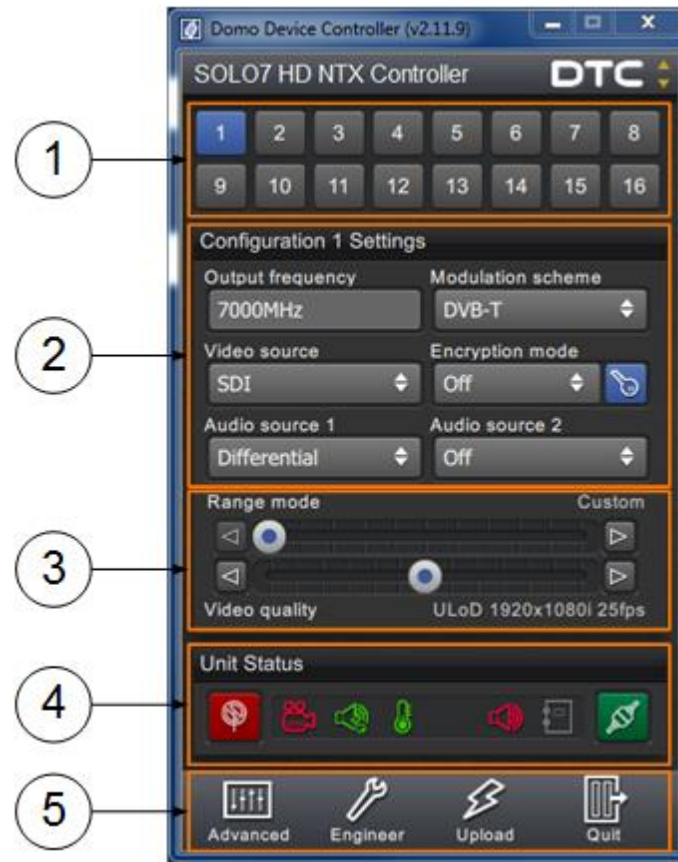

No	Name	Description
1	Configuration presets	Sixteen (or eight) preset configurations can be stored. The blue button is the currently active preset.
2	Basic settings	When you have selected a preset, the basic settings for that configuration can be edited from the primary window. These can also be configured in the Advanced window.
3	Range mode and video quality	The modulation and video settings will be automatically selected for optimum performance by using these sliders.
4	Unit status	Indicators to report things like RF Status, Video Lock, Audio Lock, Temperature and Connection Status.
5	Switch panel	Buttons to take you to: The Advanced window, the Engineer window, the Upload window and to quit the Domo Device Controller.

## 4.4 Performing a Quick Setup

The SOLO7 Transmitter can be quickly setup from the primary window.

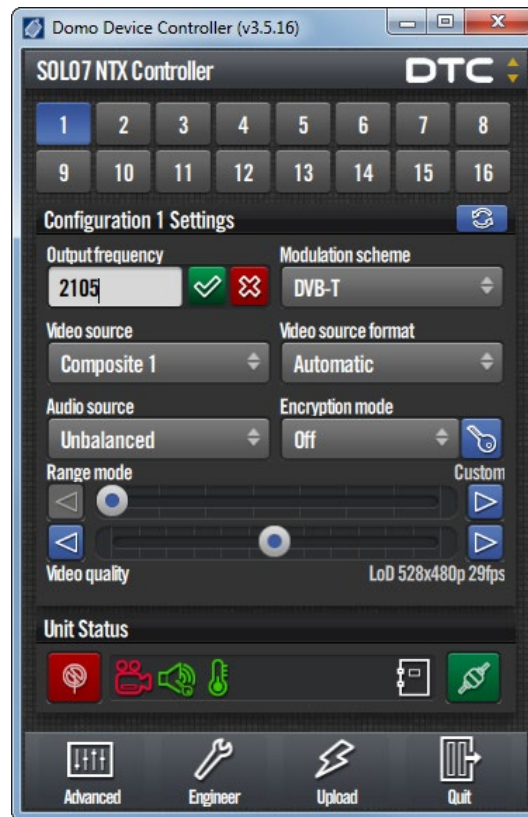

Basic Setting	Options	Description
Output frequency	A frequency in the range of the unit.	Type in the <b>frequency</b> that you want this device to use in megahertz (MHz). Click the green tick to save the setting.
Video source	Off Composite 1 Composite 2 S-Video  HD Nano TX and OBTX: SDI HDMI	Select the video source.
Audio source	Off Balanced Unbalanced  HD Nano TX and OBTX only: Embedded 1 Embedded 2	OBTX and BNTX have balanced analogue audio inputs.

Basic Setting	Options	Description
Modulation scheme	NB/UMVL DVB-T	Select the modulation scheme for the system.
Video source format	Automatic PAL NTSC NTSC NP  HD Nano TX and OBTX only: 720p50, 720p59, 720p60, 1080i50, 1080i59, 1080i60, 1080p23, 1080p24, 1080p25, 1080p29, 1080p30, 1080psf23, 1080psf24, 1080psf25, 1080psf29, 1080psf30, 1080p50, 1080p59, 1080p60, 1080dl50, 1080dl59, 1080dl60	Select the video format that matches the camera you are using.  Alternatively, the <b>Automatic</b> setting determines the video source.  Power up standard in Automatic mode defaults to PAL. This can be changed by setting the input to NTSC NP for example and then back to Automatic.  <b>Note:</b> 1080p50/59/60 equates to 3G-SDI Level A, and 1080dl50/59/60 is 3G-SDI Level B-DL
Encryption mode	Off ABS AES128 AES256	All Transmitters have ABS, but the AES modes are all license dependent.
Encryption key 	Dialog entry	Enter the encryption key.  ABS=8 characters AES128=32 characters AES256=64 characters
Range Mode	Slider adjustment	Move the slider towards the left to get shorter ranges but higher picture and audio quality.
Video Quality	Slider adjustment	The options will differ dependent on video and range settings.  Move the slider to the left to get lower resolution at a higher frame rate.

**Note:** Some modulation and encryption modes are licensed features. Unlicensed features may be marked with a padlock icon.

## 5. Domo Device Controller Operation

### 5.1 Introduction

**Note:** The HD transmitters will have some different options to the SD transmitters. Where this is the case, they will be explained.

To get the most from your radio system you must customise the programming for your operations and area.

The SOL07 Transmitter uses the **Domo Device Controller** software running on your PC which enables you to perform many configuration tasks quickly and easily. These next topics tell you how to connect your PC to the Nano Transmitter and then use your Domo Device Controller to configure the unit.

If the **Device Controller** menu shows a 'lock' symbol  next to a feature, this means that it is not available for your device variant or that it is missing a license.

**Note:** SOL70BTX can also be controlled from the front panel control interface. This is explained in detail in *Section 5.13*.

### 5.2 Unit Status Panel

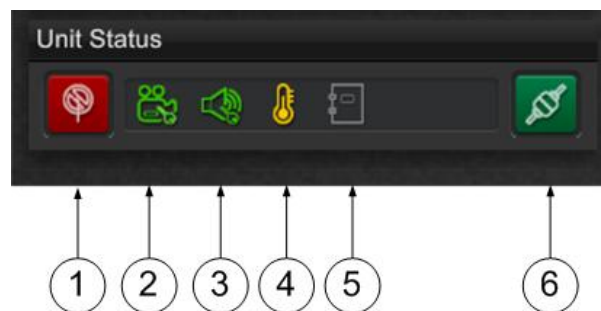

No	Name	Options	Description
1	RF Button	Red=RF off Green=RF on	Click to toggle RF on or off.
2	Video Lock	Red=unlocked Green=locked	Tells you if the unit has successfully locked to the video source. Unlocked will also be shown if video is disabled.
3	Audio Lock	Red=unlocked Green=locked	Tells you if the unit has successfully locked to the audio source. Unlocked will also be shown if audio is disabled.

No	Name	Options	Description
4	Temperature	Green Yellow Red	<p>An indication of the temperature of the FPGA. Try to keep it green.</p> <p>0°C to 59°C shown in green. 60°C to 84°C shown in yellow. 85°C or above shown in red.</p> <p><b>CAUTION:</b> If it changes to red, switch the unit off and allow it to cool.</p> <p>&gt;95°C some video encoder functionality is disabled to try and reduce temperature; video quality will be affected.</p> <p>&gt;99°C the unit will shut down and restart to avoid permanent FPGA damage.</p>
5	Logging	Greyed – unavailable White – logging	<p>Logging is normally off by default.</p> <p>Logging is enabled by using a command line switch which is fully described in <i>Section 6.2</i>.</p>
6	Connect Button	Red=disconnected Green=connected	<p>Click to connect or disconnect the Domo Device Controller serial connection.</p> <p>The application will remain open when disconnected.</p>

## 5.3 Switch Panel

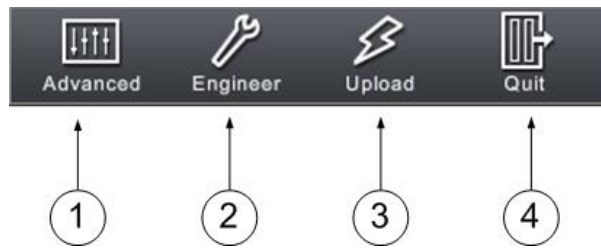

No	Name	Description
1	Advanced	<p>Open the Advanced window to access detailed parameters of the transmitter:</p> <p><b>Unit</b> – Software versions, licenses etc.</p> <p><b>Modulation</b> – Frequency, power, FEC etc.</p> <p><b>Audio</b> – Audio source, sample rate etc.</p> <p><b>Video</b> – Video source, format etc.</p> <p><b>Misc</b> – Data settings etc.</p>
2	Engineer	<p>Open the Engineer window to send and receive engineering commands or load configuration files.</p> <p>The current command list is given in <i>Section 7.7.2</i>.</p>
3	Upload	<p>Open the Upload window to upgrade firmware or license files.</p> <p><b>Note:</b> This upgrade method does not apply to OBTX. Refer to <i>Section 5.11</i> for OBTX upgrade instructions.</p>
4	Quit	Click Quit to close Domo Device Controller.



## 5.4 Advanced>Unit Window

### 5.4.1 Open the Advanced>Unit Window

1. On the primary window in the switch panel, click the **Advanced** button.
2. Click the **Unit** window.
3. Click and drag the **scrollbar** on the right of the screen to see the whole display.

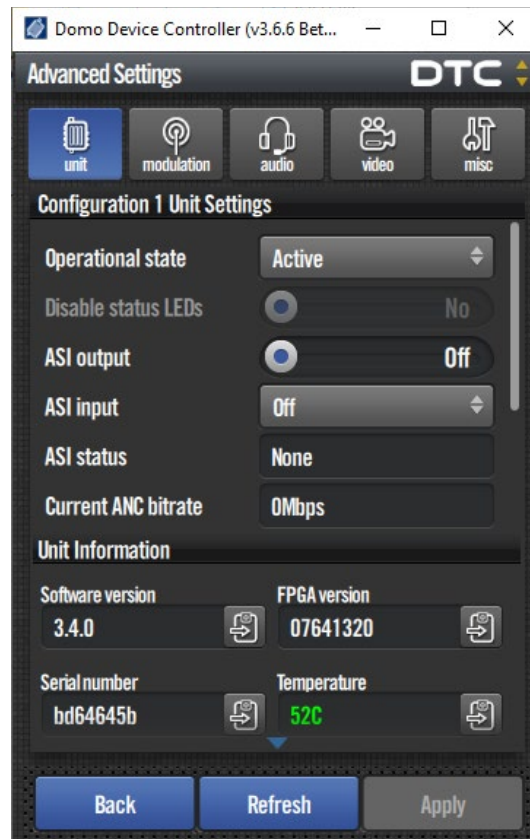

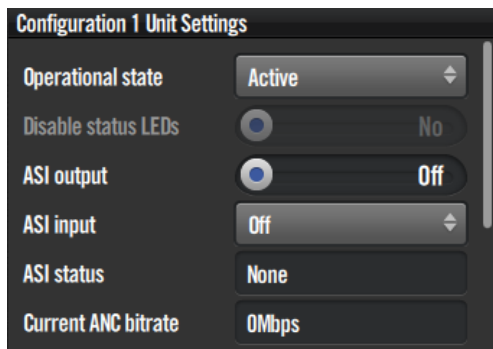

## 5.4.2 Unit Settings

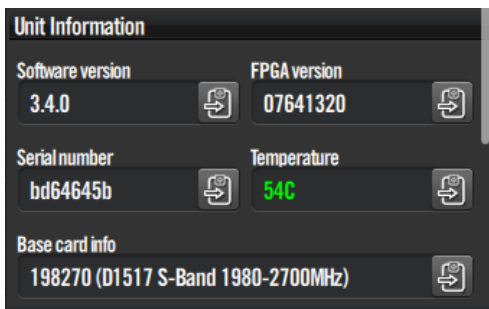

Name	Options	Notes
Operational State	Active Standby Sleep	<p><b>Active</b> – The unit is fully powered and in an operational state.</p> <p><b>Standby</b> – The unit is using less power but can be brought back to operation rapidly.</p> <p><b>Sleep</b> – The unit is consuming the least amount of power but needs to be woken before being able to operate fully.</p>
Disable status LEDs (SOL7TX only)	Blue=Off Orange=On	Swipe to the right to turn the status LEDs on the front panel <b>Off</b> .
ASI output (OBTX only)	Blue=Off Orange=On	Swipe to the right to enable ASI video output <b>On</b> .
ASI input (HDNTX, OBTX and SOL7TX)	Off On Relay	<p>When ASI input is <b>On</b>, this will add the service to the RF link.</p> <p><b>Note:</b> You will have to divide the video bit rates so that they don't exceed the transmit mux bit rate.</p> <p>In <b>Relay</b> mode, the remote service will be transmitted, turning the local service off.</p> <p><b>HDNTX Note:</b> The video input can be configured as either SDI or ASI but <b>not both</b>. If <b>ASI</b> input is selected <b>SDI</b> will be switched <b>Off</b>.</p>
ASI Status	Information	Provides the current ASI status, if relevant.
Current ANC bitrate (HDNTX only)	Information	SDI cameras/sources may include ancillary metadata. This data is identified in the service as ANC.

### 5.4.3 Unit Information



Name	Notes
	This button will copy the data to the PC clipboard. It can then be pasted into a document, for example.
Software Version	This is the version of the firmware running on the board.
Serial Number	The Electronic Serial Number (ESN) of the internal PCB. The licence file will only work with a device that has a matching ESN. <b>Note:</b> This is different to the serial number on the device label.
FPGA Version	The version of FPGA firmware currently running on the D1500 board. We may ask for this number during a support call.
Temperature	0C to 59C shown in green. 60C to 84C shown in yellow. 85C or above shown in red. An indication of the temperature of the FPGA. Attempt to keep it green. <b>CAUTION:</b> If it changes to red, switch the unit off and allow it to cool. >95°C some video encoder functionality is disabled to try and reduce temperature; video quality will be affected. >99°C the unit will shut down and restart to avoid permanent FPGA damage.
Base Card Info	The internal RF PCB in the unit with the frequency band.

## 5.4.4 Unit Actions

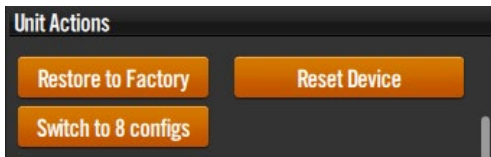

No	Name	Notes
1	Restore to Factory	Click to return the device settings to the default settings.
2	Switch to 8/16 Configs	It is possible to toggle the unit into eight configurations mode instead of sixteen.  Some options are stored on a global or configuration basis dependent on the number of configurations used.
3	Reset Device	This performs a power cycle on the device.

## 5.4.5 Licensed/Unlicensed Features

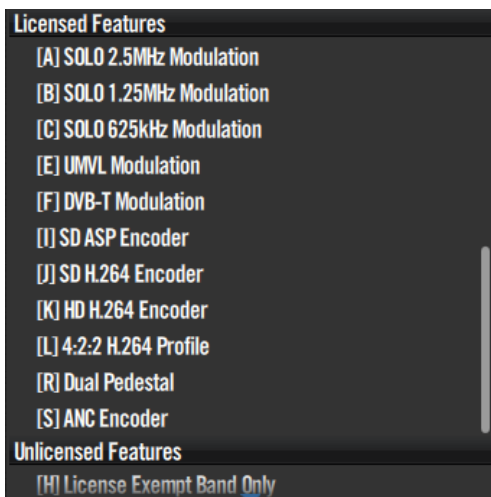

No	Name	Notes
1	Licensed Features	Licenses are given letter codes in square brackets and a note of what that license does.  Codes shown in the Licensed Features group box are enabled on your device and are available to use.
2	Unlicensed Features	Codes shown in the Unlicensed Features group box have not been enabled for your device.  To load a new license, see <i>Section 5.9</i> .

## 5.5 Advanced>Modulation Window

### 5.5.1 Open the Advanced>Modulation Window

1. On the primary window in the switch panel, click the **Advanced** button.
2. Click the **Modulation** window.
3. Click and drag the **scrollbar** on the right of the screen to see the whole display.

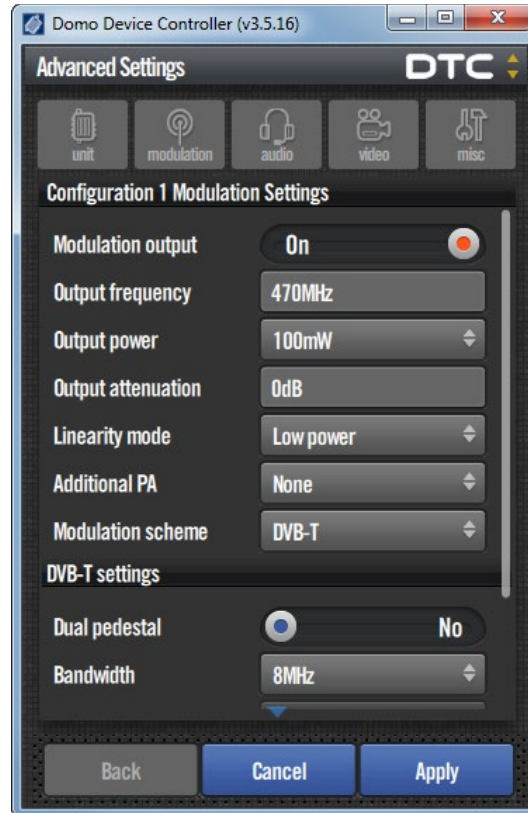

## 5.5.2 Modulation Settings

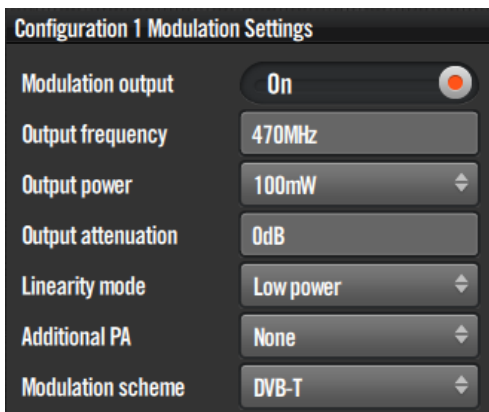

Name	Options	Notes
Modulation Output	Off or On	Switches RF on or off. Repeats the action of the RF button on the Unit Status panel on the primary window.
Output Frequency	In-band	The frequency in megahertz (MHz) that you want to use for this preset. If you try to input a frequency that is out of range, the radio will tune the nearest available frequency automatically. The transmitter frequency can be set in step sizes of 125kHz.
Output Power	10mW 50mW 100mW 200mW 500mW 1W 2W 5W	Choose the power output you want to use for your transmission. Power levels above 100mW require the addition of an amplifier. See <b>Additional PA</b> setting. Lower power outputs will run cooler which may be important for enclosed/body worn applications. <b>CAUTION:</b> The combination of 100mW output power and high linearity must only be used with additional cooling, either extra heat sinking or a fan.
Output Attenuation	0 to 31.75dB	0 to 31.75dB of attenuation can be applied to the output of the transmitter.
Linearity mode	Low power High linearity Ultra high lin	High linearity mode improves shoulder performance by several dB at the expense of power consumption. Often used when working with amplifiers which need excellent shoulder performance to operate, or for improved adjacent channel performance. See <i>Section 6.1</i> for more detail. <b>CAUTION:</b> The combination of 100mW output power and high linearity must only be used with additional cooling, either extra heat sinking or a fan.

Name	Options	Notes
Additional PA	None 500mW 1W 2W 5W	When an additional external power amplifier is attached to the SOLO7 Transmitter, you can match the amplifier rating here.  <b>Note:</b> If the PA is setup at the customer site, refer to <i>Section 6.3</i> for integration details.
Modulation Scheme	NB/UMVL DVB-T	This box enables you to select the modulation mode you want to work with. Different schemes have different settings.

### 5.5.3 Narrowband Settings

If you selected NB/UMVL for the modulation scheme, these settings need to be configured.

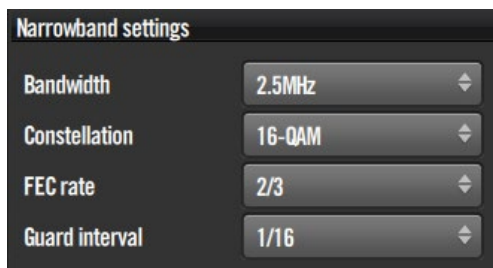

Narrowband settings

Bandwidth: 2.5MHz

Constellation: 16-QAM

FEC rate: 2/3

Guard interval: 1/16

Name	Options	Notes
Bandwidth	Narrowband: 2.5MHz 1.25MHz 625kHz  UMVL: 6MHz 7MHz 8MHz	DTC Narrowband modes provide excellent range and efficient use of available channel bandwidth.  DTC Ultra Mobile Video Link modes provide higher data throughput than Narrowband by using the same bandwidths as DVB-T. UMVL will provide an advantage over DVB-T at C/X-band in short range mobile environments.
Constellation	QPSK 16QAM BPSK 8PSK	QPSK, BPSK and 8-PSK – less user data, more robust, more range. 16QAM – more user data, less robust, less range (link performance reduced by 5db).
FEC Rate	1/3 2/3	The forward error correction (FEC) rate.  1/2 – 1 bit out of 2 bits is data and 1 bit is for error correction. 2/3 – 2 bits out of 3 bits are data and 1 bit is for error correction.  More user data means better picture quality, but less error correction means less robust signal and thus less range.

Name	Options	Notes
Guard Interval	1/16 1/8	The guard interval is an extension of the RF symbol period to give immunity to reflections.  1/32 – deals with fast reflections. More data, less range.  1/4 – deals with slower reflections. Less data, more range.

## 5.5.4 DVB-T Settings

If you selected DVB-T for the Modulation scheme, these settings need to be configured.



Name	Options	Notes
Dual Pedestal	No or Yes	Dual Pedestal mode will double the bitrate by using two adjacent COFDM channels with an approximate 1.5MHz separation. i.e. DVB-T 8MHz in dual pedestal mode will give a total bandwidth of 17.5MHz. See <i>Figure 5-1</i> .
Bandwidth	6MHz 7MHz 8MHz	DVB-T modes provide excellent data throughput but shorter range than DTC Narrowband modes.  Typically, bandwidth requirements for DVB-T depend on location and channel licensing. User data rates and range also vary slight between bandwidths.
Constellation	QPSK 16QAM 64QAM	QPSK – less user data, more robust, more range.  16QAM – more user data, less robust, less range (link performance reduced by 5db).  64QAM – max user data, least robust, least range.
FEC Rate	1/2 2/3 3/4 5/6 7/8	The forward error correction (FEC) rate.  1/2 – 1 bit out of 2 bits is data and 1 bit is for error correction.  7/8 – 7 bits out of 8 bits are data and 1 bit is for error correction.  More user data means better picture quality, but less error correction means less robust signal and thus less range.



Name	Options	Notes
Guard Interval	1/32 1/16 1/8 1/4	The guard interval is an extension of the RF symbol period to give immunity to reflections.  1/32 – deals with fast reflections. More data, less range.  1/4 – deals with slower reflections. Less data, more range.

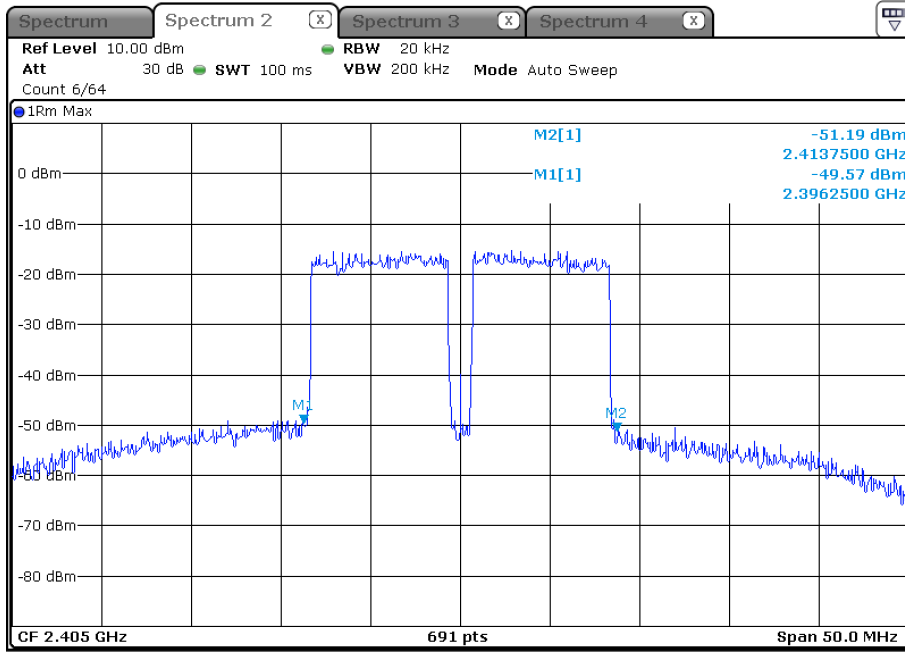
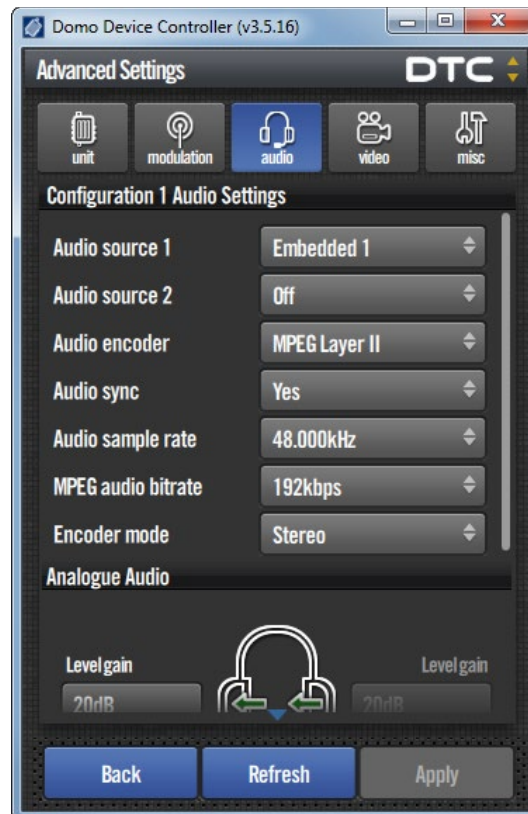

**Figure 5-1 Dual Pedestal Spectrum Analyser Plot**

## 5.6 Advanced>Audio Window

### 5.6.1 Open the Advanced>Audio Window

1. On the primary window in the switch panel, click the **Advanced** button.
2. Click the **Audio** window.
3. Click and drag the **scrollbar** on the right of the screen to see the whole display.



## 5.6.2 Audio Settings

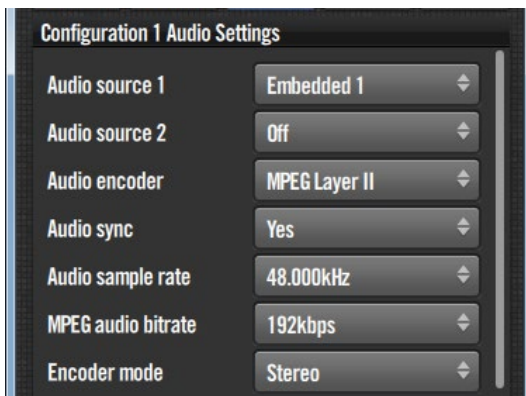

Name	Options	Notes
Audio source 1 or 2	Off Balanced Unbalanced  HDNTX and OBTX: Embedded 1 Embedded 2	OBTX and BNTX have balanced analogue audio inputs.  <b>Note:</b> NTX and HDNTX will be mono only.  Embedded – digital audio from either SDI or HDMI video.
Audio encoder	MPEG Layer I MPEG Layer II LPCM 16-bit	The higher the audio quality used the less the video bandwidth available.
Audio sync	Yes Early	Yes is where the audio is synched to the video. Early is where the audio needs to be earlier than the video.
Audio sample rate	8.000kHz to 48.000kHz	Generally, the higher the number the better the audio quality.
MPEG audio bitrate	Dependent on audio encoder	Generally, the higher the number the better the quality.
Encoder mode	Stereo Left mono Right mono Dual mono	Select the audio mode you want to use.  Dual mono allows for different gain values on the left and right channel. Stereo uses just one.

### 5.6.3 Analogue Audio

Analogue audio will be in line with the **encoder mode** setting. The arrows will point to the applicable gain value.

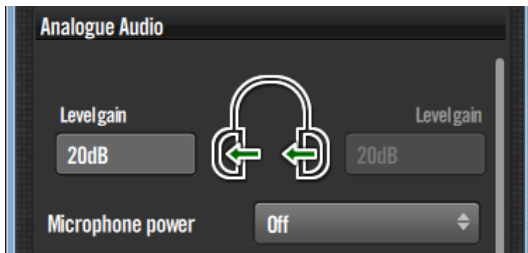

Name	Options	Notes
Level gain	0 to 66dB	You can apply different levels of gain to each channel as required. Click on the box to edit the value.
Microphone power	Off 2.0V 12.0V 48.0V	This provides phantom power to the microphone, if applicable. <b>Note:</b> 12.0V and 48.0V are only available for the OBTX.

### 5.6.4 SDI Audio



SDI provides 16 channels of embedded audio in eight pairs. This should be left at default unless an advanced user.

## 5.7 Advanced>Video Window

### 5.7.1 Open the Advanced>Video Settings

1. On the primary window in the switch panel, click the **Advanced** button.
2. Click the **Video** window.
3. Click and drag the **scrollbar** on the right of the screen to see the whole display.



## 5.7.2 Video Settings

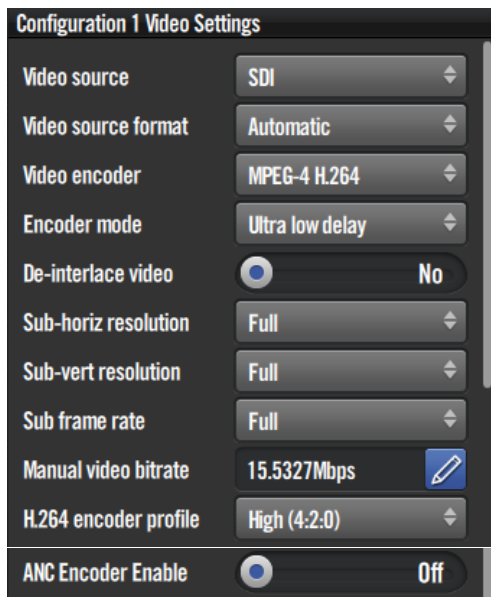

**Note:** The video encoder settings can be configured for optimum performance using the sliders on the Control Application primary window, see *Section 4.3* or refer to *Section 7.5* for guideline settings.

Name	Options	Notes
Video Source	Off Composite 1 Composite 2 S-Video  HD Nano TX and OBTX: SDI HDMI	Select the video source input.  With the supplied CA2254 breakout cable, there is one yellow RCA Phono plug for Composite 1 video.  With the optional CA2298 breakout cable you can connect two video inputs or S-Video.
Video Source Format	Automatic PAL NTSC NTSC NP  HD Nano TX and OBTX: 720p50, 720p59, 720p60 1080i50, 1080i59, 1080i60 1080p23, 1080p24, 1080p25, 1080p29, 1080p30, 1080p50, 1080p59, 1080p60 1080psf23, 1080psf24, 1080psf25, 1080psf29, 1080psf30 1080dl50, 1080dl59, 1080dl60	Select the video format that matches the camera you are using.  Alternatively, the <b>Automatic</b> setting will determine the video source.  Power up standard in Automatic mode defaults to PAL. This can be changed by setting the input to NTSC NP for example and then back to Automatic.  <b>Note:</b> 1080p50/59/60 equates to 3G-SDI Level A, and 1080dl50/59/60 is 3G-SDI Level B-DL.

Name	Options	Notes
Video Encoder	MPEG4 ASP MPEG4 H.264	MPEG4 ASP may be required backward compatibility with older receivers.  MPEG4 H.264 generally provides improved picture quality over ASP.
Encoder Mode	Standard Delay Low Delay Ultra Low Delay	Standard Delay mode provides higher picture quality at the expense of delay. Should be used with long range modulation parameters.  Ultra Low Delay mode provides exceptionally low delay at the expense of picture quality. Short range modulation parameters will generally be required.
De-interlace Option Button	Blue=OFF Orange=ON	When on, the de-interlace option converts interlaced fields to a progressive frame. This improves picture quality on PC monitor type devices. Having a progressive type of image is also easier to encode so you save bit rate too.  Don't use it if you want to preserve vertical resolution or interlaced field rate.
Sub-horiz resolution	Full 3/4 2/3 1/2 1/4	This is the fraction of the horizontal video resolution.  For an HD 1080 format, this is 1920 x 1080 where 1920 is the horizontal resolution.  If you choose <b>Full</b> you see all 1920 pixels, if you choose <b>1/2</b> you see a down-sampled picture which requires less bitrate to encode.

Name	Options	Notes
Sub vert resolution	Full 1/2 1/4	<p>This is the fraction of the vertical video resolution.</p> <p>For an HD 1080 format, this is 1920 x 1080 where 1080 is the vertical resolution.</p> <p>If you choose Full you see all 1080 lines, if you choose 1/2 you see a down-sampled picture which requires less bitrate to encode.</p> <p><b>Note:</b> Dependent on the type of video content, when using a sub-vertical resolution, you may want to enable the de-interlace option as well.</p>
Sub frame rate	Full 1/2 1/4 1/8 1/24	<p>If full frame rate is giving poor quality, you can step this down until you get an acceptable picture.</p> <p><b>Note:</b> Using a sub-frame rate will force the Encoding mode to Standard delay progressive.</p>
Manual video bitrate	Auto or User defined	Normally left in automatic. Press the Pencil button to manually set the video bit rate you want to use.
H.264 encoder profile	Baseline Main High (4:2:0) High (4:0:0) High (4:2:2)	<p>This will default to High (4:2:0).</p> <p>This should be left at default unless an advanced user.</p>
ANC Encoder Enable (HDNTX only)	Blue=OFF Orange=ON	SDI cameras/sources may include ancillary metadata. Set to ON to add ancillary data.

### 5.7.3 SDI Video

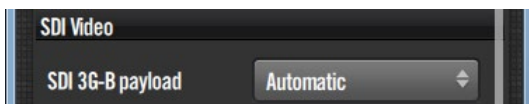

HDNTX only. This provides support for HD-SDI formats over 3G-SDI dual stream video input and should be left at default (**Automatic**) unless an advanced user.



## 5.7.4 Compatibility

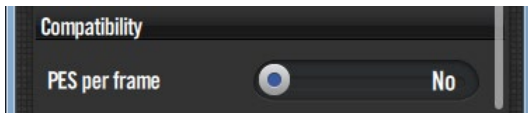

PES per frame can be set to Yes as a compatibility requirement for some video management systems (VMS). This should be left at No unless an advanced user.

## 5.8 Advanced>Misc Window

### 5.8.1 Open the Advanced>Misc Window

1. On the primary window in the switch panel, click the **Advanced** button.
2. Click the **Misc** window.
3. Click and drag the **scrollbar** on the right of the screen to see the whole display.

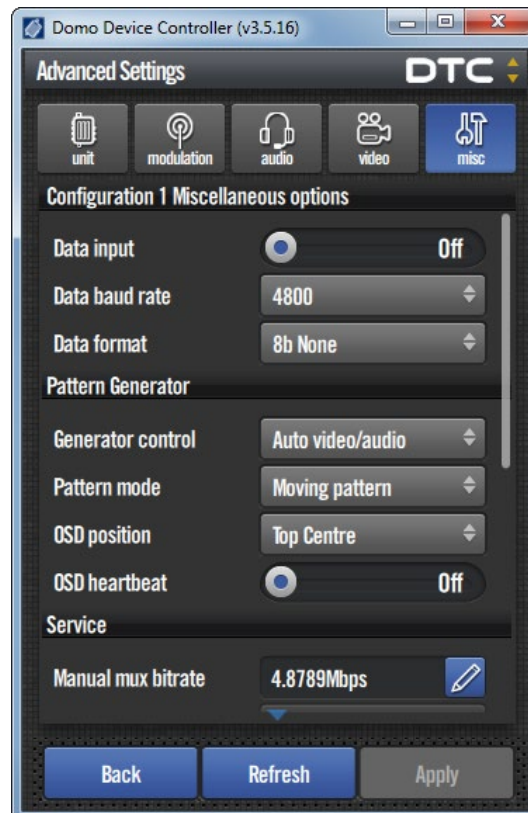

## 5.8.2 Miscellaneous Options

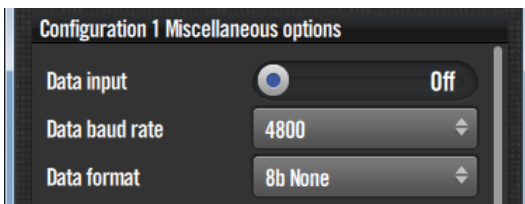

Name	Options	Notes
Data Input	Off On	Selects if RS232 data is passed over the link.
Data Baud Rate	1200 to 115200	This is the speed of serial data running through the unit. This must match the data source you are planning to use.
Data Format	8b None 8b Even 8b Odd 7b None 7b Even 7b Odd	When you have switch data on, you can select from one of the available modes.  8b (8-bit data) or 7b (7-bit data) must match the data source, as must the parity.

## 5.8.3 Pattern Generator

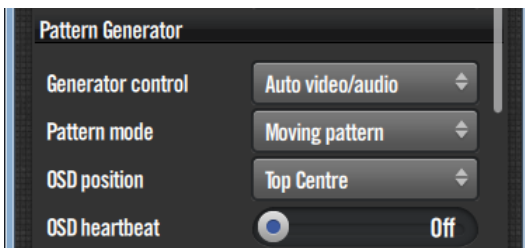

Name	Options	Notes
Generator control	Disabled Force on Auto video/audio Auto video Auto audio AV sync	Off Permanently on (overrides all other video) Will display pattern or emit tone if video or audio signal is missing Will display pattern if video signal is missing Will emit tone if audio signal is missing Will display an AV sync pulse only
Pattern mode	Various	A list of choices of pattern generator display.
OSD position	Various	Selects the position of an On-Screen Display (OSD) which will appear on your screen when you play video.
OSD heartbeat	Off or On	The OSD heartbeat adds a pulsing symbol to the video output. This may be helpful in images with no discernible movement.

## 5.8.4 Service Options

The screenshot shows a configuration window titled "Service" with the following fields and values:

- Manual mux bitrate: 4.8789Mbps (with an edit icon)
- Network name: DTC
- Service name: Solo-01
- Program number: 1
- PMT PID: 32 (with an edit icon)
- PCR PID: 300 (with an edit icon)
- Video PID: 300 (with an edit icon)
- Audio 1 PID: 200 (with an edit icon)

Name	Options	Notes
Manual mux bitrate	Auto/manual	When set to 0 the mux bit rate is defined automatically based on modulation settings.  When set manually with RF output turned off. This overrides the automatic calculation. In this case it can be used to adjust the stream rate on the ASI outputs.
Network name	Default: DTC	The Network Name applies to the transport stream (TS). Inside that TS there may be many Services each with a Service Name.  Click in the box to edit.
Service name	Default: Solo-01	This is an identifier for the service within the transport stream (TS). This must match the name at the receiver for the service to be decoded.  Click in the box to edit.
Program number	1 to 16	The Program Number uniquely identifies the channel in a transport stream. All channels in a chained system must have a different Program Number which can be decoded at the receiver.  Click in the box to edit.
PIDs	32 to 8190	The packet ID numbers are automatically allocated, according to the Program number.  The PIDs can be edited but should be left to default unless an advanced user.

## 5.9 Licensing Upgrade

If you require a new license for your device, this will be supplied to you by DTC. You will need to know the device electronic serial number (ESN) which can be found in the Device Controller **Advanced>Unit** window. The license file format is:

*<serial\_number>-<ESN>-<license\_number>.lic*, e.g. *AK000143-8e417fdb-133444.lic*

On the primary window in the switch panel, click the **Upload** button to open the **Upload** window.

Click the blue folder button under **Upload License File** to browse any mapped drives you have on your PC.

Navigate to where you saved your license file. Click the license file to select.



Click the **Upload** button. You'll see the **Upload Status** change to **Upgrade Succeeded** on completion.

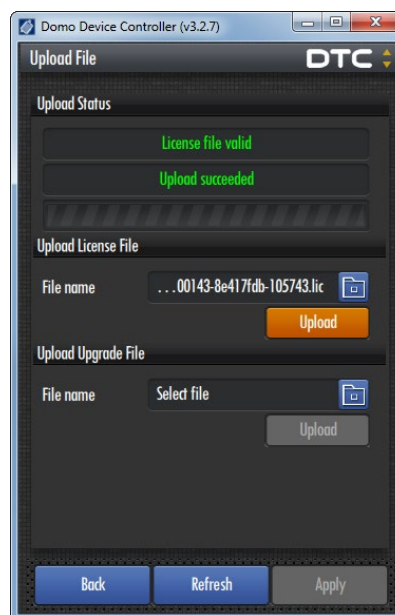

## 5.10 Firmware Upgrade – SOL07 NTX/HDNTX/BNTX/TX

When you need to do a software upgrade, the files will be made available through DTC's Watchdog facility.

The upgrade file for the SOL7NTX and SOL7TX will be in the format *d1500\_vx.x.all*.

The upgrade file for the SOL7HDNTX and SOL7BNTX will be in the format *d1600\_vx.x.all*.

**Note:** From software v2.0 onwards, a bespoke 64x32 pixel customer logo may be applied. The logo file can be provided by DTC and will look like *d1600\_logo\_dtc.all*. To remove the logo, DTC will provide a blank file.

On the primary window in the switch panel, click the **Upload** button to open the **Upload** window. Click the blue folder button under **Upload License File** and navigate to the upgrade file and select.



Click the **Upload** button and note the status on the Device Controller screen. The upload process may take around 20 minutes to complete.

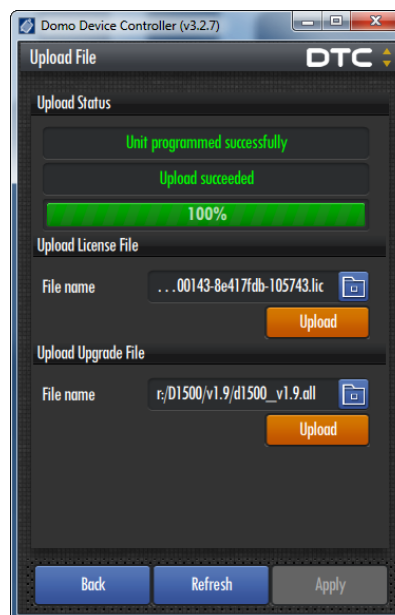

## 5.11 Firmware Upgrade – SOL70BTX

When you need to do a software upgrade, the files will be made available through DTC's Watchdox facility.

The upgrade file for the OBTX will be in the format *d1600\_vx.x.all*.

**Note:** From software v2.0 onwards, a bespoke 64x32 pixel customer logo can be applied. The logo file can be provided by DTC and will look like *d1600\_logo\_dtc.all*. To remove the logo, DTC will provide a blank file.

### 5.11.1 Before you Begin

- Connect your PC to the OBTX using the serial control cable (CA0343)
- Install Tera Term Pro on your PC

**Note:** Tera Term v3.1.3 is the recommended version which is available on DTC's Watchdox facility if other versions are found to have issues.

### 5.11.2 Upgrade the OBTX

**Note:** You will need to find out the Com Port that your OBTX is using by powering up and looking in your PC's Device Manager.

1. Ensure the OBTX is not powered and control cable (CA0343) is connected to unit and to the PC.
2. On the front panel interface change **Local Settings>Terminal Mode** to **Yes**.
3. Start Tera Term Pro and open a new connection by selecting **Setup>Serial Port** with the settings shown below with the appropriate Com port.

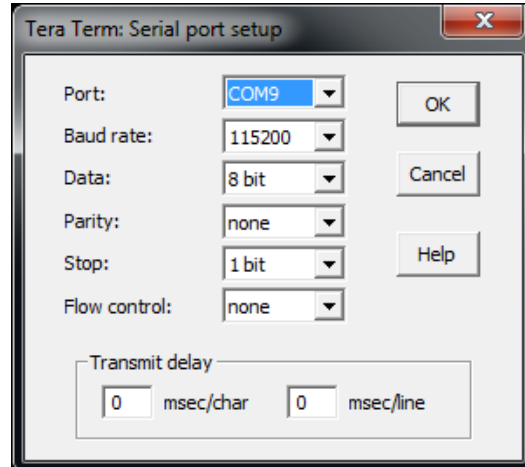

4. Ensure you have Tera Term selected on the PC and switch on the power supply to the OBTX.
5. Almost immediately press the **x** key, this will start the S-Record loader, then type a capital **A** (**shift+a**) to select Full upgrade, or capital **L** (**shift+l**) if only uploading a logo file.

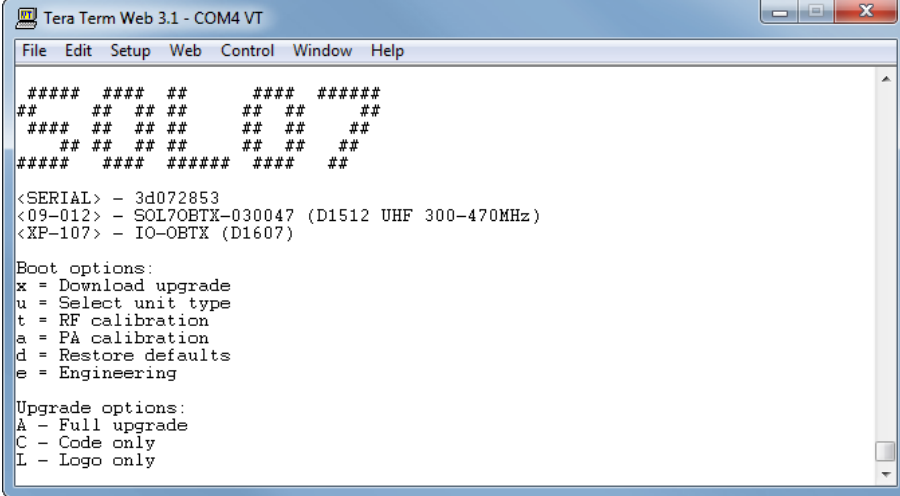

```

#####  ###  ##      ###  #####
##  ##  ##  ##  ##  ##  ##
###  ##  ##  ##  ##  ##  ##
##  ##  ##  ##  ##  ##  ##
#####  ###  #####  ###  ##

<SERIAL> - 3d072853
<09-012> - SOL7OBTX-030047 (D1512 UHF 300-470MHz)
<XP-107> - IO-OBTX (D1607)

Boot options:
x = Download upgrade
u = Select unit type
t = RF calibration
a = PA calibration
d = Restore defaults
e = Engineering

Upgrade options:
A - Full upgrade
C - Code only
L - Logo only

```

6. The erase could take a couple of minutes to complete. Progress is shown by an increasing number of # characters. Once complete **Download code:** will be shown in Tera Term.
7. Select **File>Send File** and ensure the **Binary** checkbox is checked as shown below. Select the upgrade file and click **Open**.

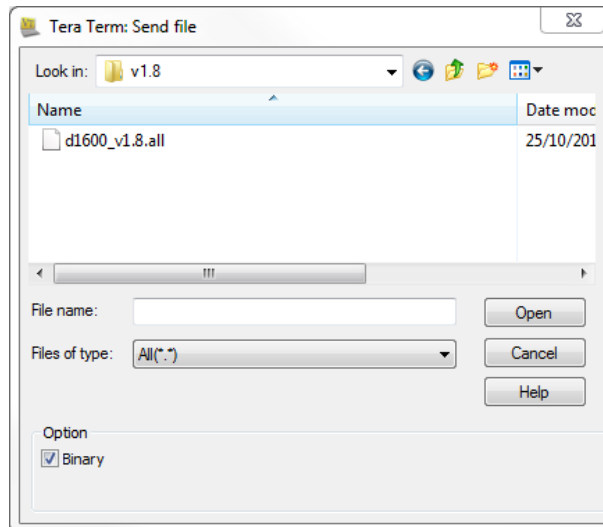

8. A progress box will appear as shown below. This will disappear once the file transfer is complete. Progress is also shown by an increasing number of – and + characters on the terminal display.

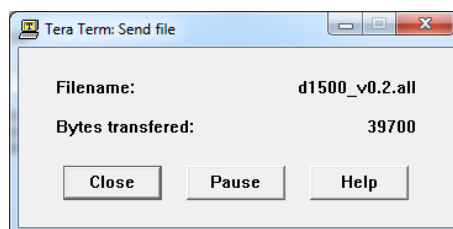

9. When the file transfer is complete, the OBTX will respond on Tera Term with a series of messages. **Verifying** followed by **Programming** with progress characters.

10. When programming is complete, the OBTX will reboot and Tera Term will respond similar to below.

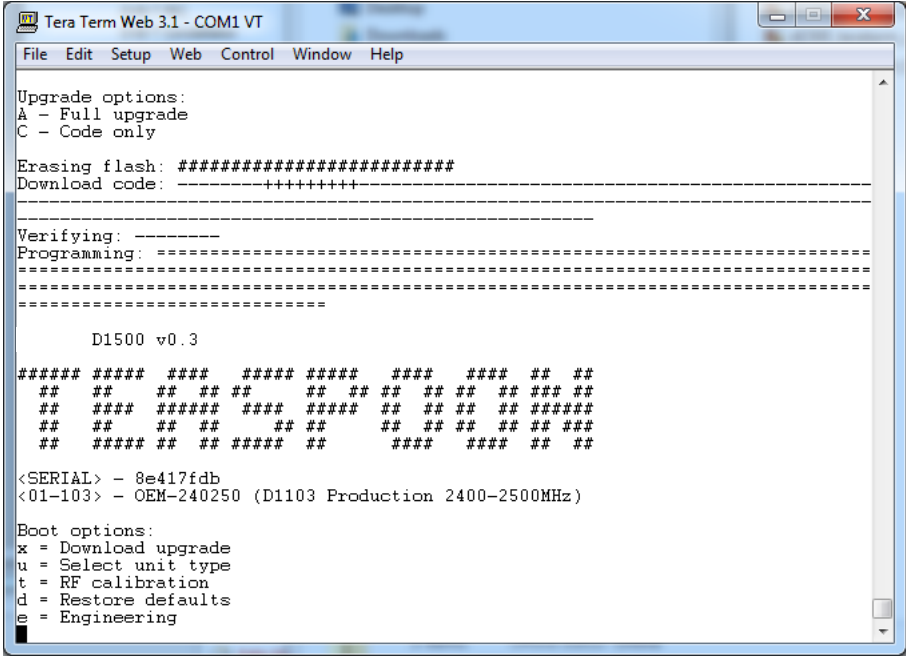

```
Tera Term Web 3.1 - COM1 VT
File Edit Setup Web Control Window Help
Upgrade options:
A - Full upgrade
C - Code only
Erasing flash: #####
Download code: -----+++++++
-----
Verifying: -----
Programming: -----
-----
D1500 v0.3
#####
## ## ## ## ## ## ## ## ## ## ## ## ## ## ## ##
## ## ## ## ## ## ## ## ## ## ## ## ## ## ## ##
## ## ## ## ## ## ## ## ## ## ## ## ## ## ## ##
## ## ## ## ## ## ## ## ## ## ## ## ## ## ## ##
<SERIAL> - 8e417fdb
<01-103> - OEM-240250 (D1103 Production 2400-2500MHz)
Boot options:
x = Download upgrade
u = Select unit type
t = RF calibration
d = Restore defaults
e = Engineering
```

## 5.12 Front Panel Interface Upgrade – SOL70BTX

When you need to do a software upgrade, the files will be made available through DTC's Watchdog facility.

The upgrade files for the front panel interface are packaged in the **FCON – D588** software. Save the *D588\_vX\_X.all* and *D588-full-menu\_vX\_X.zip* files to a convenient location on your PC.

### 5.12.1 Before you Begin

- Connect your PC to the OBTX using the serial control cable (CA0343)
- Install Tera Term Pro on your PC

**Note:** Tera Term v3.1.3 is the recommended version which is available on DTC's Watchdog facility if other versions are found to have issues.

### 5.12.2 Upgrade the Interface

**Note:** Find the Com Port that your OBTX is using by powering up and looking in your PC's **Device Manager**.

1. Ensure the OBTX is not powered and disconnect control cable (CA0343) from the unit but keep the USB end connected to the PC.
2. Whilst holding down the large (right hand) front panel interface button, connect control cable (CA0343) to the **CTRL** connector on the OBTX. The display will show:

**D588 bootloader**

**UP = start**

3. Release the button, then move the same button upwards. The display will then show:

**Erasing Flash followed by Start Download**



4. Start Tera Term Pro and open a new connection by selecting **Setup>Serial Port** with the settings shown below with the appropriate COM port.

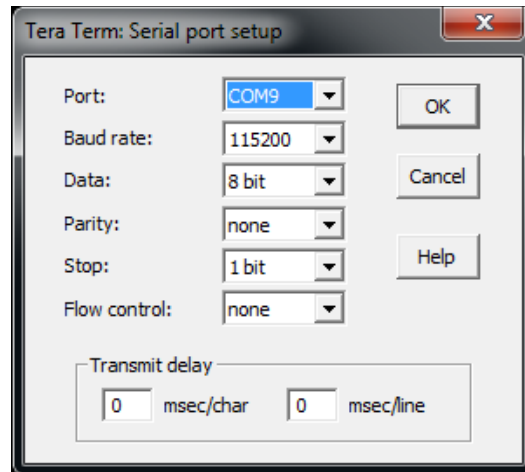

5. Select **File>Send File** and ensure the **Binary** checkbox is checked as shown below. Navigate to the full code file labelled *D588\_vX\_X.all* and click **Open**.

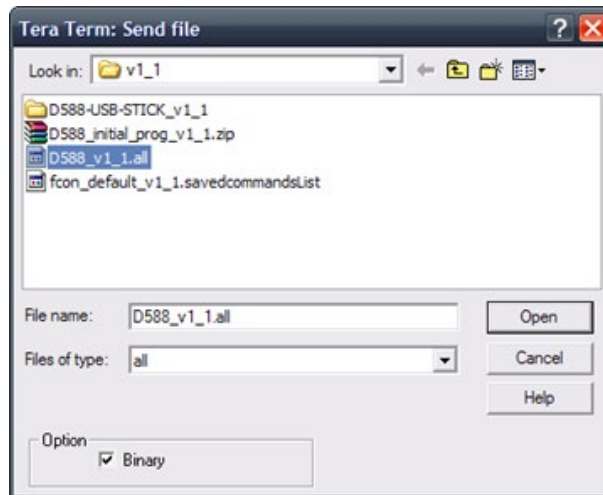

6. A progress box will appear as shown below. This will disappear once the file transfer is complete.

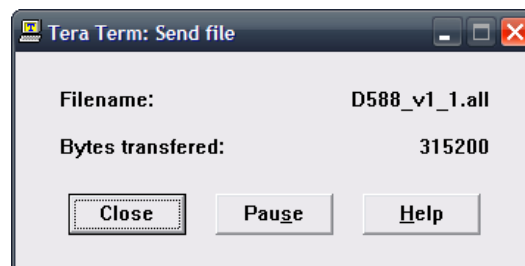

7. If the code has been accepted, the front panel interface will reboot automatically.



## 5.13 User Control Interface – SOL70BTX only

### 5.13.1 The Control Interface

The OBTX has a user control interface on the front panel to enable you to make changes to the settings without the need for a PC and application software.

1. When you power up, the display will illuminate.
2. The left button is used to **Cancel** an operation or move **Back** one level in the menu structure.
3. The right button is used to **Navigate** through the menu by pushing the button up, down, left or right and to **Confirm** a selection by pushing the button in the centre. It can also be used to change the value of a property.



### 5.13.2 Unit Status Menu Structure

Top Menu	Second Level	Function
Unit Status	Range desc	Shows current range setting
	Vid desc	Shows current video quality setting
	Vid lock	Shows video lock status
	ASI status	Shows current ASI lock status
	Mux rate	Shows the current Mux rate.
	S/W Ver	Shows current software version of the transmitter.
	Serial	Shows electronic serial number of the internal PCB.
	FPGA ver	Shows current FPGA version number/functionality
	Temp	Shows the internal temperature of the FPGA

### 5.13.3 Unit Control Menu Structure

Top Menu	Second Level	Third Level	Function
Unit Control	RF	Output	Set modulation output On or Off

Top Menu	Second Level	Third Level	Function
		Freq	Set unit frequency
		Mod mode	Set the modulation scheme
		Power	Set the RF output power
		Lin mode	Set the linearity mode
	NB/UMVL	Bandwidth	Set narrowband bandwidth
		Const	Set the constellation
		FEC	Set the FEC rate
		Guard	Set the guard interval
	DVB-T	Bandwidth	Set DVB-T bandwidth
		Const	Set the constellation
		FEC	Set the FEC rate
		Guard	Set the guard interval
	Video	Source	Set the video source
		Format	Set the video source format
		Mode	Set the encoder mode
		Deinterlace	Set de-interlace video No or Yes
		Horz res	Set sub-horiz resolution
		Vert res	Set sub-vert resolution
		Sub f/rate	Set sub frame rate
		Profile	Set H.264 encoder profile
		Encoder	Set video encoder
	Audio	Source 1	Set audio source 1
		Source 2	Set audio source 2
		Encoder	Set the audio encoder
		Samp rate	Set the audio sample rate
		Bitrate	Set the MPEG audio bitrate
		Mode	Set the encoder mode
		Gain S/LM	Set the stereo or left mono gain

Top Menu	Second Level	Third Level	Function
		Gain RM	Set the right mono gain
		Mic power	Set microphone power
	Data	Input	Set data input On or Off
		Baud	Set the data baud rate
		Format	Set the data format
		Mode	Set the data mode for Low latency or Low bitrate <b>Note:</b> This setting may not appear in the current Device Controller application
	Misc	Generator	Set the pattern generator control
		Pattern	Set the pattern generator mode
		Network	Set the network name
		Service	Set the service name
		Prog Num	Set the program number
	Scram	Scram	Set the encryption mode
		ABS key	Set the ABS encryption key
		AES key 1	Set AES key 1
		AES key 2	Set AES key 2
	Unit	ASI out	Set ASI output On or Off
		ASI in	Set ASI input Off, On or Relay
		Config	Set one of the sixteen available configs
		State	Set the operational state Active, Standby or Sleep
		Defaults	Set defaults to Yes to restore unit to default configurations

### 5.13.4 Local Settings Menu Structure

Top Menu	Second Level	Function
Local Settings	Serial	Shows unit serial number
	S/W Ver	Shows loaded software version of FCON controller

Top Menu	Second Level	Function
	Name	Set unit name
	Menu Level	Set FCON menu availability (Full, Basic or User)
	SOLO4 FP	Change the FCON display to SOLO4 mode (On or Off)
	RS232 Ctrl	Set RS232 control function (On or Off)
	Status Display	Show frequency on FCON display (On or Off)
	LEDs	Sets the internal FCON LEDs On or Off.
	Voltage Disp	Shows voltage input on FCON screen (On or Off)
	Low Batt Disp	Shows Low battery warning (On or Off)
	Low Batt	Set voltage at which Low battery warning appears (0-16V)
	Brightness	Sets FCON display brightness (a number between 0 and 255)
	Disp Mode	Set FCON display power-save mode (On, Auto Dim, Auto Off)
	Boot Logo	Show DTC boot logo on start-up (On or Off)
	Poll Write	Not intended to operate with SOLO7 Transmitters.
	Terminal Mode	When set to Yes, will override RS232 internal settings to allow terminal communications for upgrades.
	Time	Shows Time Stamp
	Date	Shows Date Stamp

## 6. Advanced Operation

### 6.1 High Linearity and Low Power Modes

Refer to *Section 5.5.2*.

#### 6.1.1 Low Power Mode

Low Power Mode optimises DC power consumption but to do this it must compromise the quality of the COFDM waveform shoulders. Compromising the shoulders often makes little difference operationally when you just need to get a short-range link in a reasonable RF environment.

What Low Power Mode *does* do, however, is save a considerable amount of power so you can deploy a unit on batteries for extended times.

The table below gives power consumption figures for SOL7NTX when in Low Power Mode:

RF Output Power	VHF/UHF	L-Band	S-Band
10mW (10dBm)	3.1W	3.3W	3.4W
50mW (17dBm)	3.4W	3.6W	3.7W
100mW (20dBm)	3.7W	3.9W	4W

#### 6.1.2 High Linearity Mode

**CAUTION:** The combination of 100mW output power and High Linearity Mode must only be used with additional cooling, either extra heat sinking or a fan.

High Linearity Mode optimises the quality of the COFDM waveform shoulders but to do this it must increase DC power consumption.

This mode can be useful when you are using an external amplifier which always expects very high-quality shoulders to work at its best.

Also, in busy RF environments you'll need excellent shoulders to reject adjacent channel interference.

The tables below give a comparison between the modes across different frequency bands:

DC Power	RF Power Out (dBm)	Current (mA)	Mode	Wattage
10	20	395	Low	3.95
10	17	330	Low	3.30
10	10	300	Low	3.00
10	20	455	High	4.55
10	17	380	High	3.80
10	10	320	High	3.20

**Table 6-1 Typical Power Consumption 1650 to 2400MHz (High L and S-Band)**

DC Power	RF Power Out (dBm)	Current (mA)	Mode	Wattage
10	20	390	Low	3.90
10	17	355	Low	3.55
10	10	325	Low	3.25
10	20	465	High	4.65
10	17	375	High	3.75
10	10	340	High	3.40

**Table 6-2 Typical Power Consumption 200 to 300MHz (VHF)**

### 6.1.3 About DC Power Use

SOLO7 Transmitter is very power efficient. In earlier models of transmitter, if you switched from high to low RF power, the same DC power level would be used although the RF signal was attenuated.

In these newer transmitters, when you select lower RF powers the DC power level is dropped too, using just the power needed to achieve the RF power required.

This stepping down of the DC power level applies to both Low Power Mode and High Linearity Mode.



## 6.2 Domo Device Controller Logging Mode

### 6.2.1 Set up Logging Mode

Right-click the Domo Device Controller shortcut on your desktop and click on **Properties**.

Select the **Shortcut** tab and in the Target box add `/l "log.txt"` to the end of the line.

**Note:** In the target box you must leave the quote marks on the original target line, leave a space then forward slash, lowercase L, quote mark, log.txt, close quote.

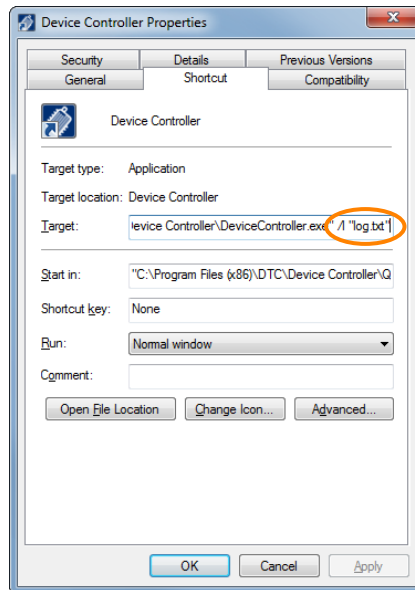

Click the **OK** button.

Open Domo Device Controller and observe the logging symbol.

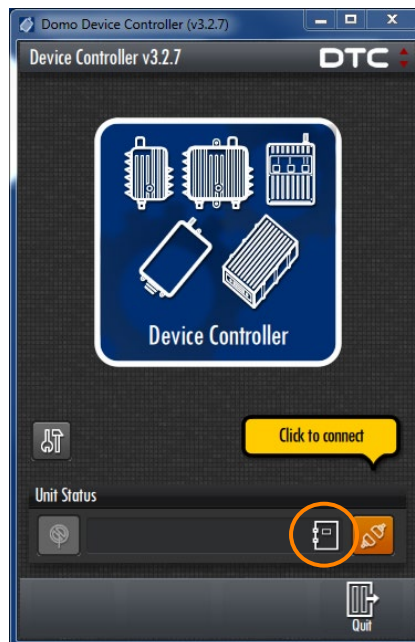

## 6.2.2 Recovering the Logging File

Right-click the Domo Device Controller shortcut on your desktop and click on **Properties**.

Select the **Shortcut** tab and click **Open File Location** button.

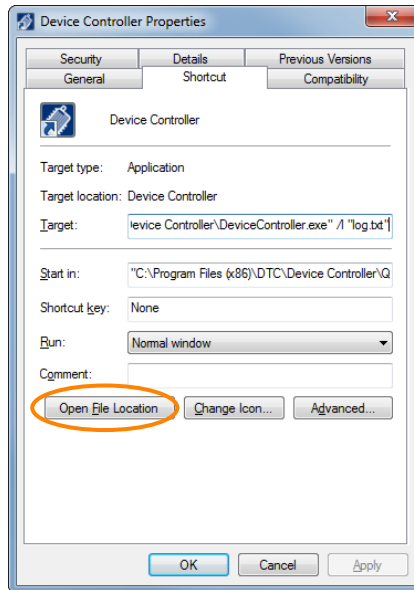

Windows Explorer opens where your Log file (and Domo Device Controller application) is located. Double-click the log.txt file.

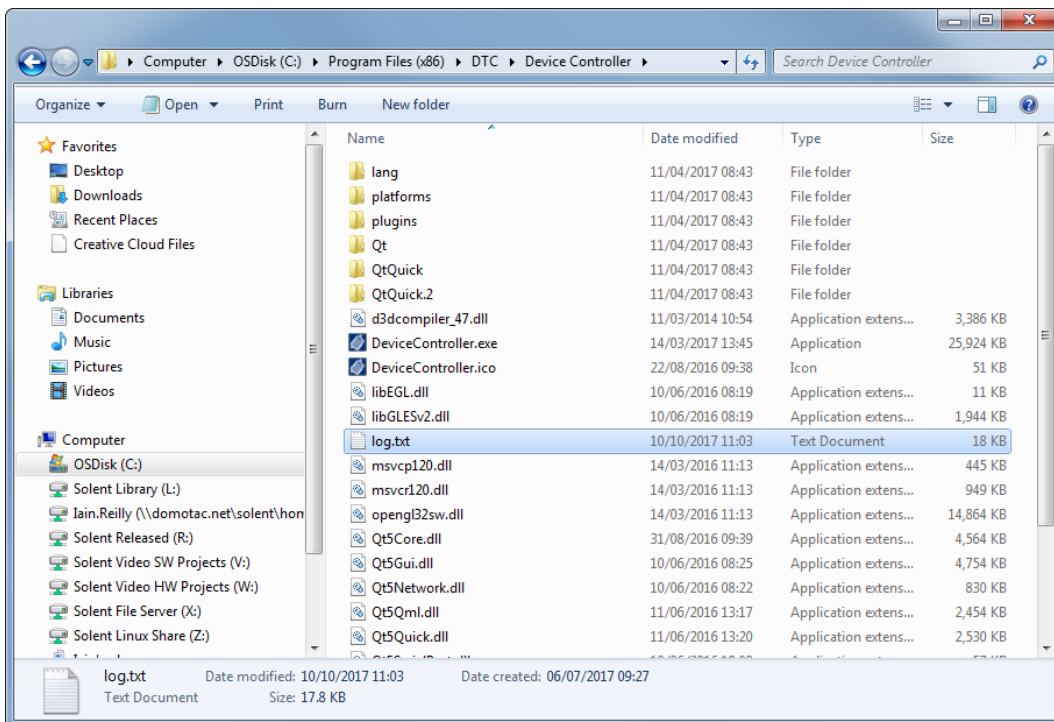

The log.txt file opens and displays your logged events.

**Note:** You may have to close the Domo Device Controller application to force all log contents to be written to disk.

## 6.3 Amplifier Integration

### 6.3.1 Introduction

If you have purchased a DTC amplifier, these instructions will help you connect a SOLO7 Transmitter and calibrate the RF power output for optimum performance.

1W, 2W and 5W amplifiers are available from DTC. Ensure the amplifier is in the same frequency band as the transmitter.

### 6.3.2 Connections

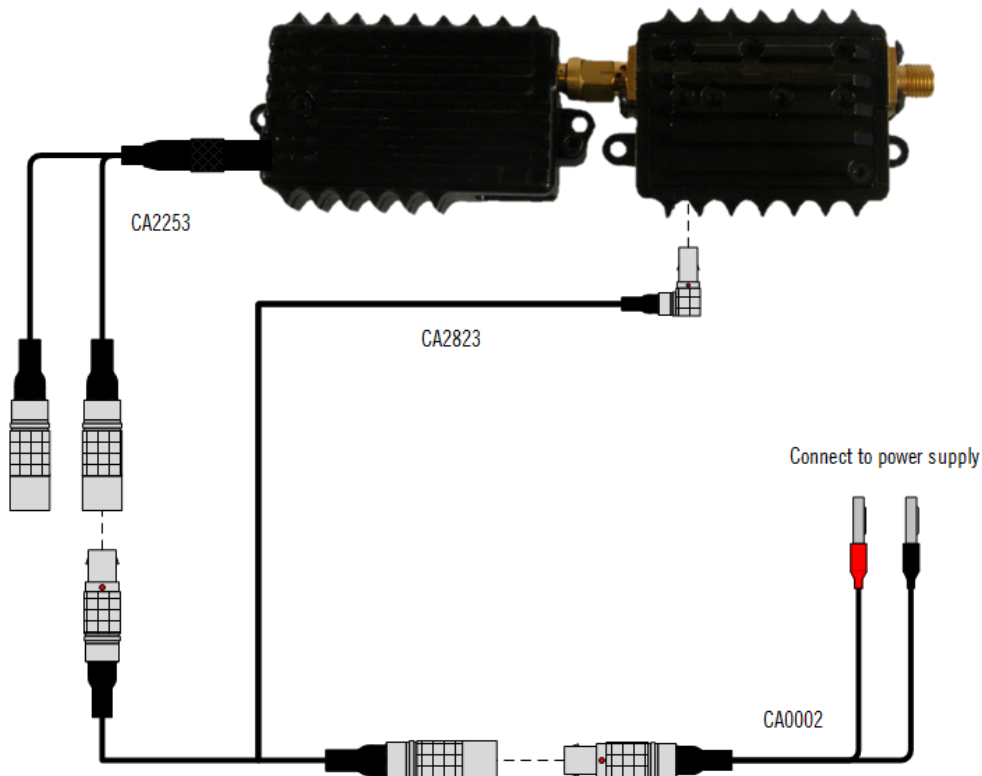

The example above shows a SOLO7 Nano Transmitter connected to a SOLO7 Nano Amplifier. An interface cable is required to provide power to the SOLO7 Transmitter and the amplifier. The principle of connection is the same for all amplifier variants.

**Note:** A set of cables for DTC amplifiers can be supplied to facilitate integration.

### 6.3.3 Calibration

When the physical pairing has been made, the transmitter and amp can be calibrated to ensure a consistent output across the bandwidth.

**Note:** PA calibration may not be supported for all amplifier variants. The options will be displayed in Tera Term, an example is shown below.

This is what you will need to perform the calibration:

- Power meter
  - Power sensor (suitably rated or with additional attenuation to prevent damage to the power meter.)
  - PC or laptop with Tera Term (terminal emulation program)
1. Connect the SOLO7 transmitter to a PC via an RS232 serial connection.
  2. Connect the RF output from the amplifier to the power meter sensor.
  3. Open Tera Term on the PC.
  4. Apply power to the SOLO7 transmitter and amplifier pair and almost immediately press 'a' to setup **PA calibration**.

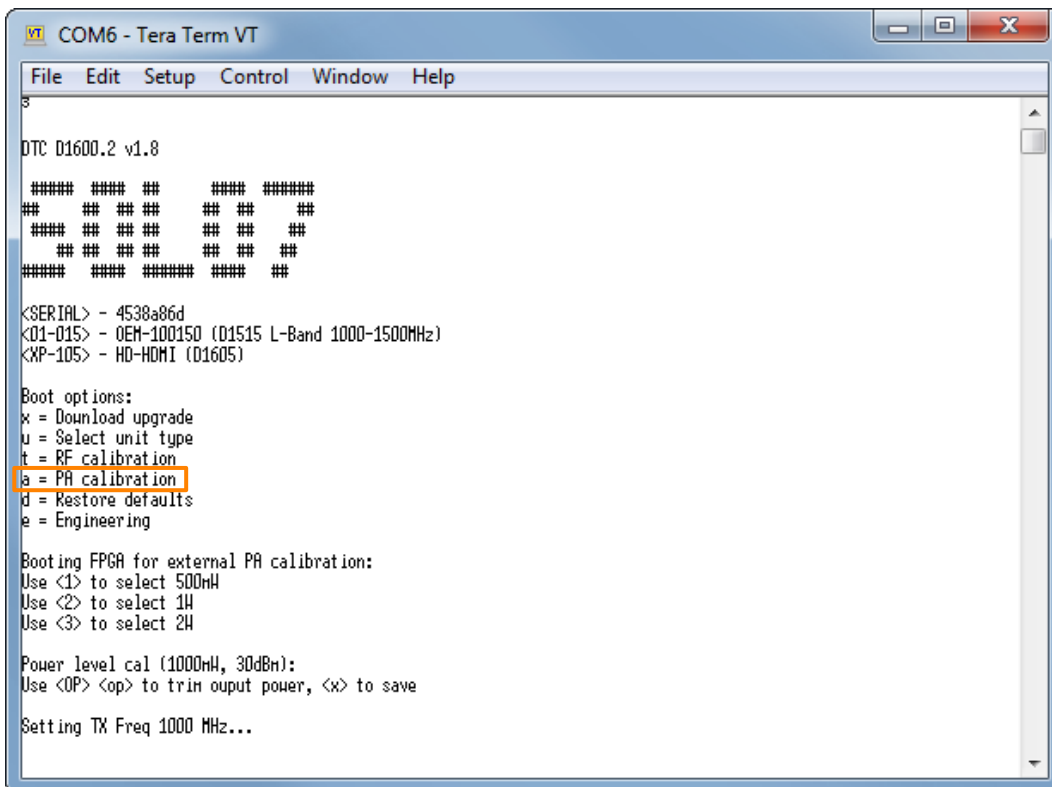

```

COM6 - Tera Term VT
File Edit Setup Control Window Help
DTC D1600.2 v1.8

#####  #####
##  ##  ##  ##  ##  ##
#####  ##  ##  ##  ##
##  ##  ##  ##  ##  ##
#####  #####  #####  ##

<SERIAL> - 4538a86d
<D1-D15> - 0EH-100150 (D1515 L-Band 1000-1500MHz)
<XP-105> - HD-HDMI (D1605)

Boot options:
x = Download upgrade
u = Select unit type
t = RF calibration
a = PA calibration
d = Restore defaults
e = Engineering

Booting FPGA for external PA calibration:
Use <1> to select 500mW
Use <2> to select 1W
Use <3> to select 2W

Power level cal (1000mW, 30dBm):
Use <OP> <op> to trim output power, <x> to save

Setting TX Freq 1000 MHz...
  
```

5. Select the number corresponding to the power rating of the amplifier, for example '2' for a 1W amplifier.
6. The first calibration frequency at the bottom end of the bandwidth will be enabled.
7. Press 'o' and 'p' on your keyboard to adjust the level in small steps or 'O' and 'P' (capitals) to make large steps.
8. Adjust the power level on the meter to a tolerance of  $\pm 0.25\text{dBm}$ .
9. Press 'x' to save the setting and continue.

10. Complete this process through all calibration set frequencies. **External PA calibration complete** will be displayed at the end of the calibration process.
11. You can now power down the SOL07 transmitter and amplifier pair.

**Note:** If the amplifier is paired with a different transmitter, the calibration process will need to be repeated.

# 7. Appendix A – Reference Material

## 7.1 Temperature Considerations

### 7.1.1 SOL7NTX Body Mount Precautions

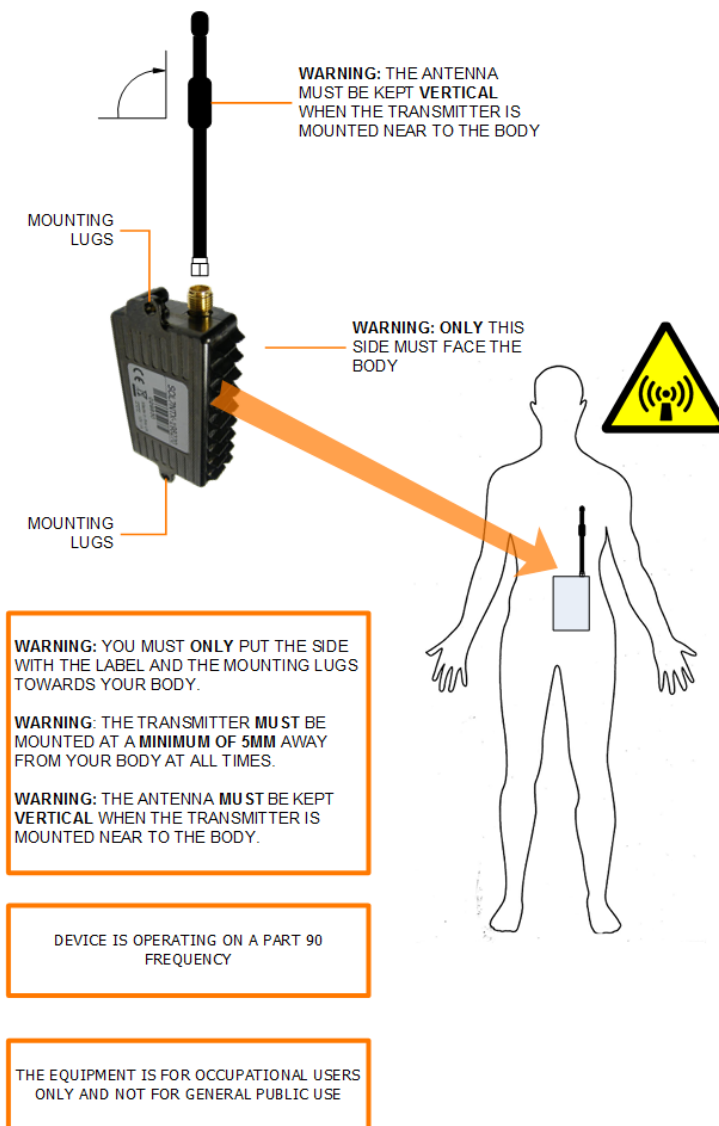

## 7.1.2 Temperature Control Tips

The SOL07 Transmitters can get very hot, therefore, it is worth noting some configurations and environmental conditions that can help mitigate any temperature concerns.

**Note:** The FPGA temperature can be monitored as a colour coded scheme on the Domo Device Controller primary window or from the **Advanced>Unit** tab to monitor the actual temperature in °C of the on-board FPGA device, see *section 5.4.2*.

1. Use a heatsinking plate, thermal conductivity will help draw heat from the SOL07 Nano Transmitter case.
2. Lower the **Output power** if operational conditions allow, see *Section 5.5.2*.
3. Switch **Linearity mode** to **Low power**, if operational conditions allow, see *Section 5.5.2*.
4. Change the video encoder format to MPEG4 ASP if operational conditions allow, see *Section 5.7.2*.

## 7.2 Pinout – SOL7NTX

### 7.2.1 AV Connector – Omnetics Tri-Lobe Latching 9-way Receptacle

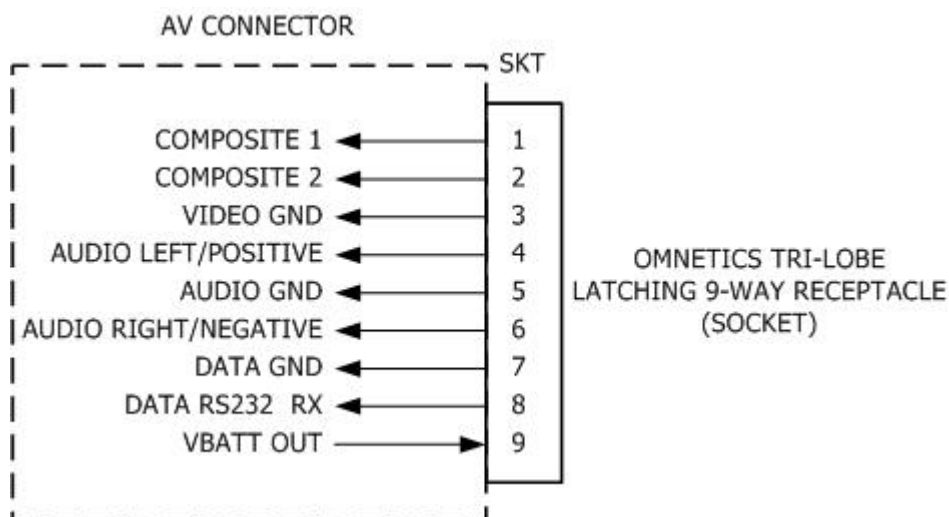

### 7.2.2 Power/Control Connector – Omnetics Nano Circular 6-way Receptacle

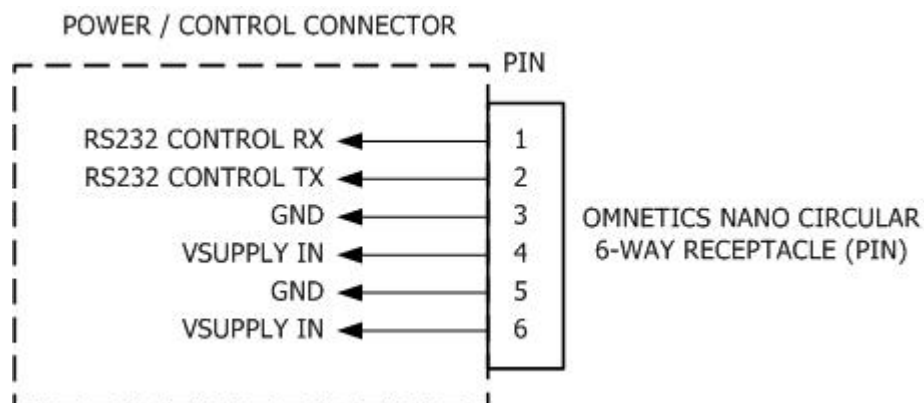

### 7.2.3 CA2298 SOL7NTX External 9-way Breakout Cable Assembly

This cable assembly has a 9-way plug at one end and a 3-way Molex plug at the other for you to connect to the cameras supplied in the kit version of SOL7NTX Nano Transmitter.

There are five bare wires which you can use to make cables to suit your own application. Of course you can remove the Molex plug to get at those cables too.

The diagram shows the signal/power on the Molex and bare wires.

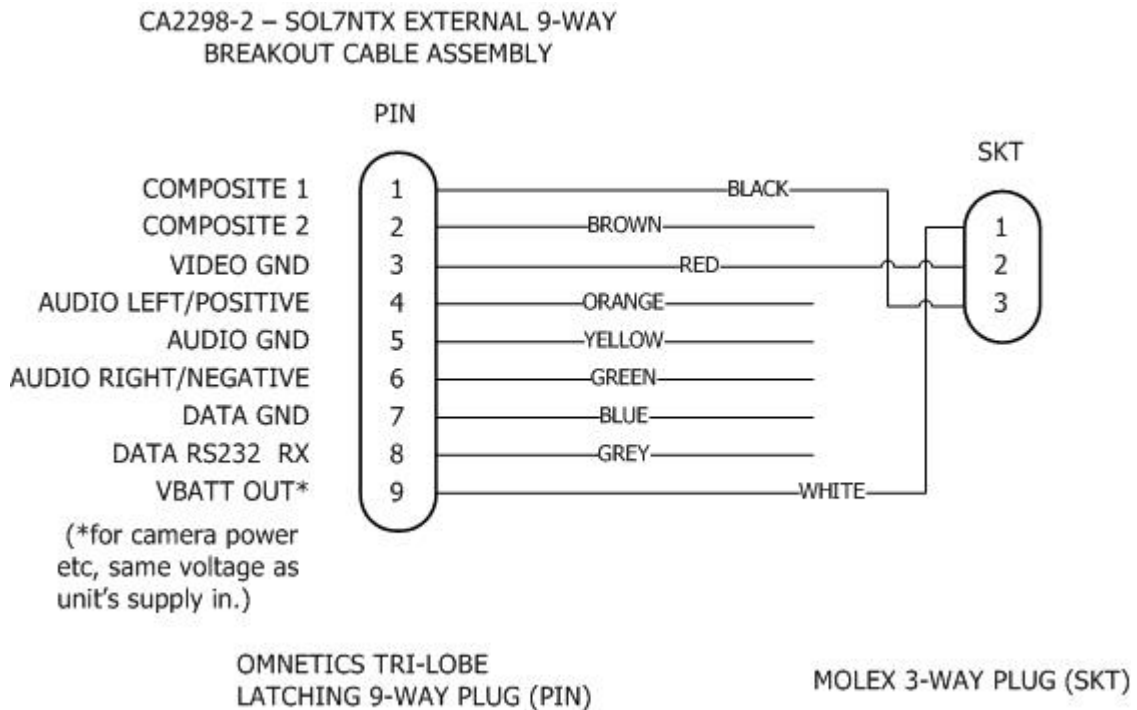



## 7.3 Pinout – SOL7TX

### 7.3.1 16-Way Hirose

Pin	Signal Name
1	12V In
2	GND
3	RS232 Ctrl Tx
4	RS232 Ctrl Rx
5	1V8 GPIO
6	RS232 Data Rx
7	Ext PA Enable
8	Chain Clk I/O
9	GND
10	Chain Data I/O
11	Audio In R
12	GND
13	Audio In L
14	GND
15	Comp Video 1
16	Comp Video 2

## 7.4 Pinout – SOL70BTX

### 7.4.1 Data/CVBS

0B Lemo 7-way – EEG.0B.307.CLL

Pin	Signal Name
1	GND
2	Composite 1
3	GND
4	Composite 2
5	GND
6	RS232 RX
7	VBATT Out

### 7.4.2 PA Power/Ctrl

00 Lemo 4-way – EEG.00.304.CLL

Pin	Signal Name
1	VBATT Out
2	VBATT Out
3	GND
4	PA Enable

### 7.4.3 Balanced Audio

0B Lemo 5-way – EEA.0B.305.CLL

Pin	Signal Name
1	Left (H)
2	Left (C)
3	GND
4	Right (H)
5	Right (C)

## 7.4.4 Power

0B Lemo 4-way – EEG.0B.304.CLL

Pin	Signal Name
1	VBATT In
2	VBATT In
3	GND
4	GND

## 7.4.5 USB Ctrl

0B Lemo 6-way – EEF.0B.306.CLL

Pin	Signal Name
1	RS232 TX
2	RS232 RX
3	GND
4	USB 5V In
5	USB Data (H)
6	USB Data (C)

## 7.4.6 Camera Control

Circular HIROSE 10-way – HR10A-10R-10P(73)

Pin	Signal Name
1	RS422 TX (H)
2	RS422 TX (C)
3	RS422 RX (H)
4	RS422 RX (C)
5	GND
6	RS232 TX
7	RS232 RX
8	N/C
9	N/C
10	GND

## 7.4.7 Tally

0B Lemo 5-way – EGG.0B.305.CLL

Pin	Signal Name
1	GND
2	VBATT Out
3	Red
4	Green
5	N/C

## 7.5 Recommended Manual Video Encoder Settings

**Note:** The preferred method to set range and video quality settings would be to use the sliders explained in *Section 4.3*. This section may be used as a guideline for manual settings only.

The SOLO7 Transmitter can offer transmission bitrates from 150kbps<sup>-1</sup> to almost 30Mbps<sup>-1</sup>. The DTC product uniquely offers this wide data rate range in the marketplace. When a user chooses a lower bitrate link they will achieve much greater range than standard achieved by a DVB-T link. Range increases of 2 to 5 times over DVB-T are possible.

DTC encoding products provide the user with a wide range of settings so that a user can trade-off increased image resolution vs frame rate vs latency for any chosen COFDM link mode.

DTC Video Encoders offer both **Standard Delay** and **Low Delay** settings. **Standard Delay** provides between 0.5 to 1 second delay for bitrates above 1Mbps and slightly longer delays as the bitrate is reduced. **Low Delay** typically reduces the end-to-end delay by a factor of 4 to 8. When operating with COFDM links below 600kbps of bitrate it is recommended to only use Standard Delay mode.

### 7.5.1 Recommended Single SD Video Settings

*Table 7-1* details settings for a **single** standard definition (**SD**) video input in NTSC or PAL format.

System and Bandwidth	Modulation Type	Bitrate	SD Video NTSC/PAL Low Delay	SD Video NTSC/PAL Standard Delay
DVB-T 8MHz	QPSK 1/2 Guard 1/32	6 Mbps	Full resolution	Full resolution
Narrowband 2.5MHz	16QAM 2/3	4.8Mbps	Full resolution	Full resolution
Narrowband 2.5MHz	QPSK 2/3	2.4Mbps	3/4 horizontal Full frame rate	Full resolution
Narrowband 1.25MHz	QPSK 2/3	1.2Mbps	Low delay progressive 3/4 horizontal Full frame rate	3/4 horizontal Full frame rate
Narrowband 625MHz	QPSK 2/3	600kbps	N/A	Progressive 3/4 horizontal 1/2 frame rate
Narrowband 625MHz	BPSK 2/3	300kbps	N/A	Progressive 1/2 horizontal 1/2 frame rate

**Table 7-1 Typical Single SD Video Settings**

## 7.5.2 Recommended Single HD Video Settings

Table 7-2 details settings for a **single** high definition (HD) video input.

**Note:** 'Res H' refers to the horizontal resolution setting on the video encoder.

'Res V' refers to the vertical resolution setting on the video encoder.

'Frame' refers to the selected frame rate – so '1/2 frame' would be 15 video frames per second on a 1080P30 mode or 30 frames per second on a 720p60 encoded image. The DTC encoder allows 1/4, 1/8 and even 1/24 frame rates to be selected.

System and Bandwidth	Modulation Type	Bitrate	Standard Delay		Low Delay	
			HD Video 720p	HD Video 1080p30	HD Video 720p	HD Video 1080p30
DVB-T 8MHz	QPSK 2/3 Guard 1/32	8 Mbps	Full Res H Full Res V Full Frame	Full Res H Full Res V Full Frame	3/4 Res H Full Res V Full Frame	3/4 Res H Full Res V Full Frame
DVB-T 8MHz	QPSK 1/2 Guard 1/32	6 Mbps	3/4 Res H Full Res V Full Frame	3/4 Res H Full Res V Full Frame	2/3 Res H Full Res V Full Frame	2/3 Res H Full Res V Full Frame
Narrowband 2.5MHz	16QAM 2/3	4.8Mbps	3/4 Res H Full Res V Full Frame	3/4 Res H Full Res V Full Frame	2/3 Res H Full Res V Full Frame	2/3 Res H Full Res V Full Frame
Narrowband 2.5MHz	QPSK 2/3	2.4Mbps	1/2 Res H Full Res V Full Frame	1/2 Res H Full Res V Full Frame	1/2 Res H 1/2 Res V Full Frame	1/2 Res H 1/2 Res V Full Frame
Narrowband 2.5MHz	QPSK 1/3	1.2Mbps	1/2 Res H 1/2 Res V 1/2 Frame	1/2 Res H 1/2 Res V 1/2 Frame	N/A	N/A
Narrowband 1.25MHz	QPSK 2/3	1.2Mbps	1/2 Res H 1/2 Res V 1/2 Frame	1/2 Res H 1/2 Res V 1/2 Frame	N/A	N/A
Narrowband 1.25MHz	QPSK 1/3	600kbps	1/2 Res H 1/2 Res V 1/4 Frame	1/2 Res H 1/2 Res V 1/4 Frame	N/A	N/A
Narrowband 625MHz	QPSK 2/3	600kbps	1/2 Res H 1/2 Res V 1/4 Frame	1/2 Res H 1/2 Res V 1/4 Frame	N/A	N/A

**Table 7-2 Typical Single HD Video Settings**

### 7.5.3 Image Resolution vs Frame Rate

It is also possible to enhance image resolution by reducing the frame rate. *Table 7-3* should be compared with *Table 7-2* to illustrate how this can be achieved.

System and Bandwidth	Modulation Type	Bitrate	Standard Delay	
			HD Video 720p	HD Video 1080p30
DVB-T 8MHz	QPSK 1/2 Guard 1/32	6 Mbps	Full Res H Full Res V 1/2 Frame	Full Res H Full Res V 1/2 Frame
Narrowband 2.5MHz	16QAM 2/3	4.8Mbps	Full Res H Full Res V 1/2 Frame	Full Res H Full Res V 1/2 Frame
Narrowband 2.5MHz	QPSK 2/3	2.4Mbps	2/3 Res H Full Res V 1/2 Frame	2/3 Res H Full Res V 1/2 Frame
Narrowband 2.5MHz	QPSK 1/3	1.2Mbps	1/2 Res H Full Res V 1/4 Frame	1/2 Res H Full Res V 1/4 Frame
Narrowband 1.25MHz	QPSK 2/3	1.2Mbps	1/2 Res H Full Res V 1/4 Frame	1/2 Res H Full Res V 1/4 Frame
Narrowband 625MHz	QPSK 2/3	600kbps	1/2 Res H Full Res V 1/8 Frame	1/2 Res H Full Res V 1/8 Frame

**Table 7-3 Alternative Resolution and Frame Rate Settings**

## 7.6 Install Device Drivers – SOL70BTX

The OBTX requires the installation of a driver on the PC before communications can be established. The driver can be found on the Field Controller files on the USB Flash Stick but the installation will differ dependent on the Windows Operating System version.

### 7.6.1 Windows 7, XP and Vista

When you plug the OBTX into a PC USB port for the first time, the windows hardware update wizard will initialise.



Select **No, not this time** and click **Next**.

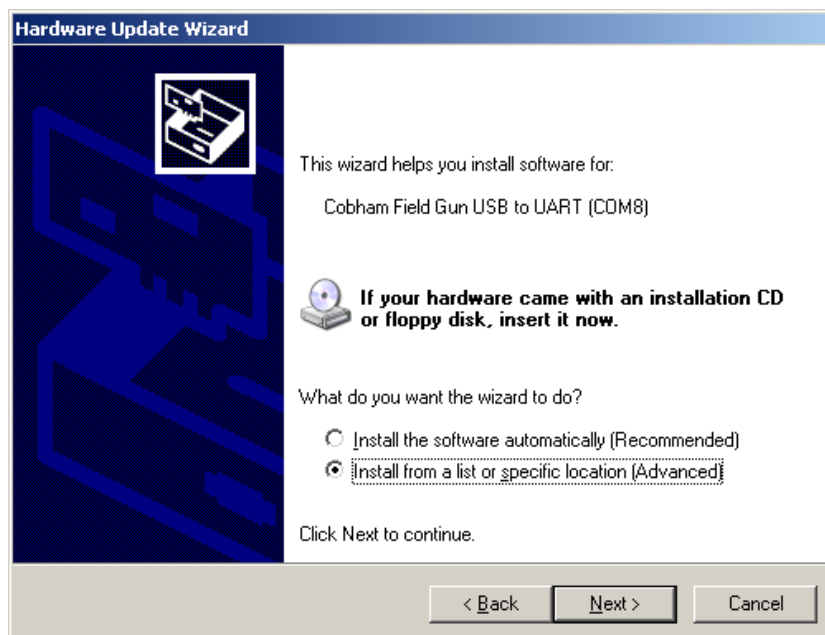



Select **Install from a list or specific location** and click **Next**.

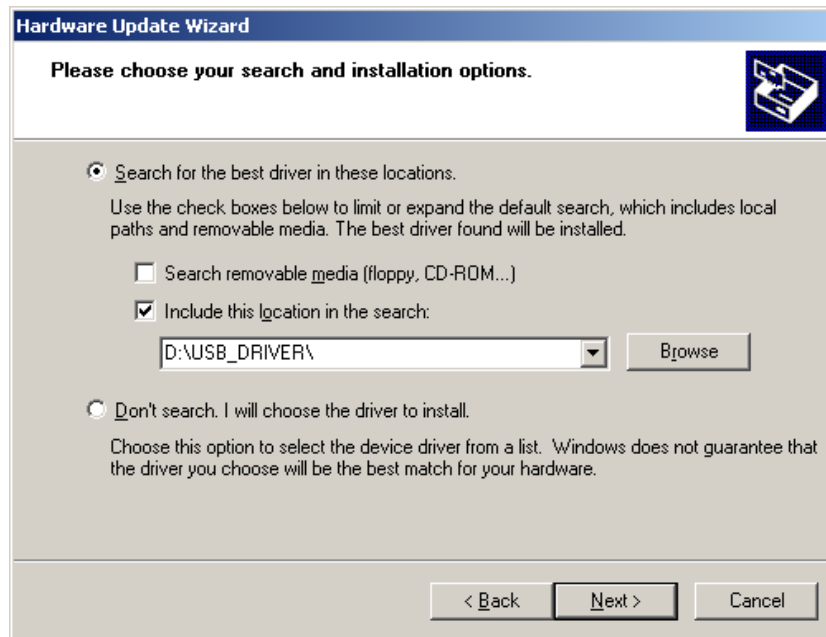

Select **Include this location in the search** and **Browse** to the USB stick where the USB\_DRIVER directory is located. Click **Next**.



Windows will pop up a message declaring that the driver has not been verified. Click **Continue Anyway**. Finally click **Finish** to end the driver installation. The Field Controller and PC are now ready to go.

## 7.6.2 Windows 8 and 10

Before the drivers can be installed, you may first need to disable driver signature verification on your PC.

To disable driver signature verification, we're going to need to get into the Troubleshooting options from the boot manager.

Simply hold down the **SHIFT** key while you click **Restart** from the power options menu (on Windows 8 that's under Charms or on the login screen, and in Windows 10 it's on the Start Menu).

You can use this trick on any of the power menus in Windows 8 or 10.

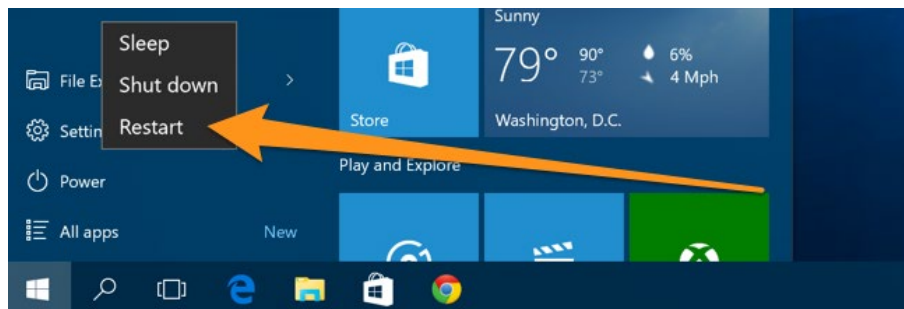

Once your computer has rebooted you will be able to choose the **Troubleshoot** option.

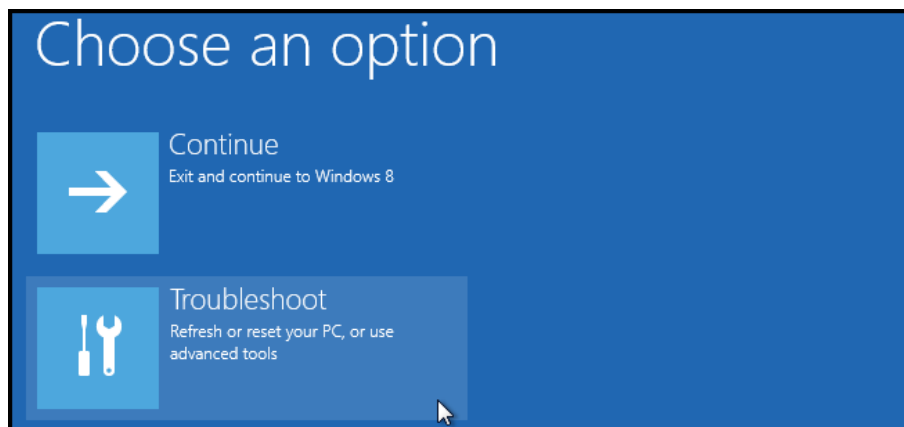

Then head into **Advanced** options.

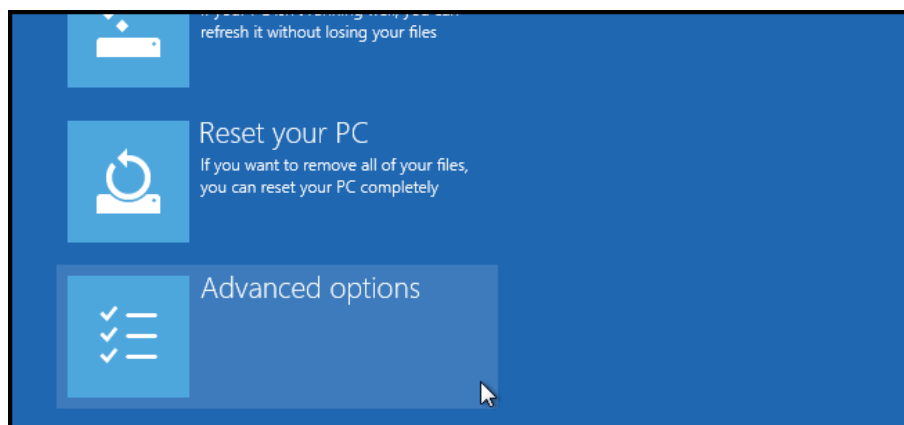

Then **Startup Settings**.

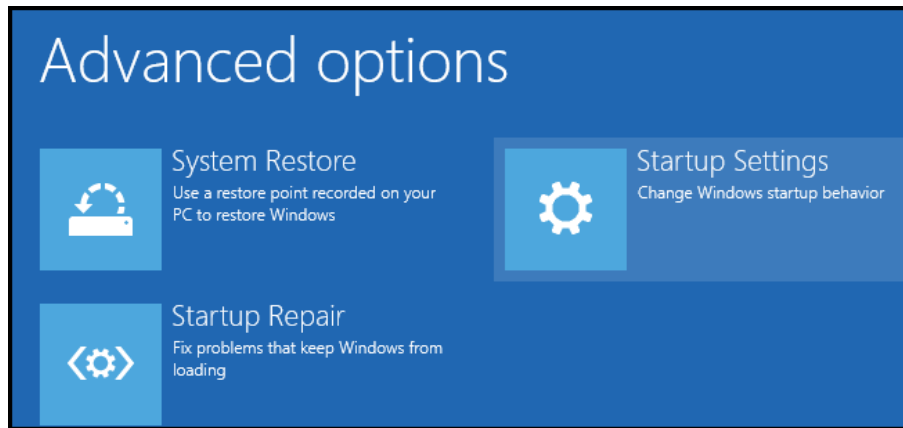

Since we are modifying boot time configuration settings, you will need to **Restart** your Computer again.

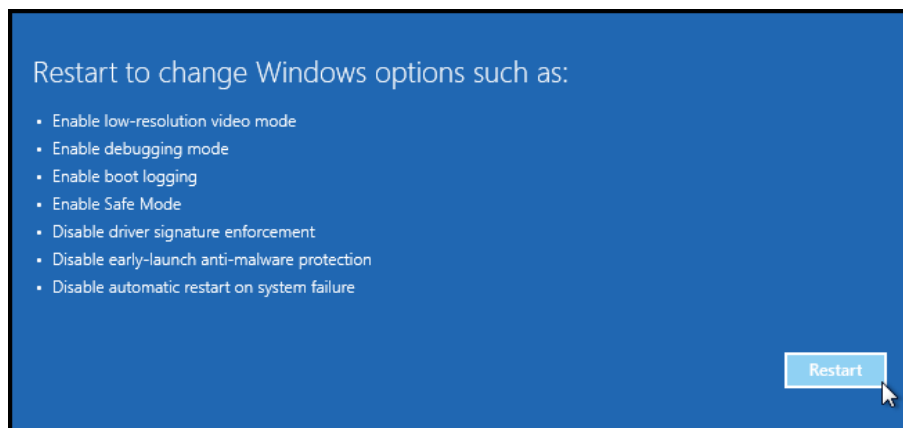

Finally, you will be given a list of **Startup Settings** that you can change. The one we are looking for is **Disable driver signature enforcement**. To choose the setting, you will need to press the F7 key.

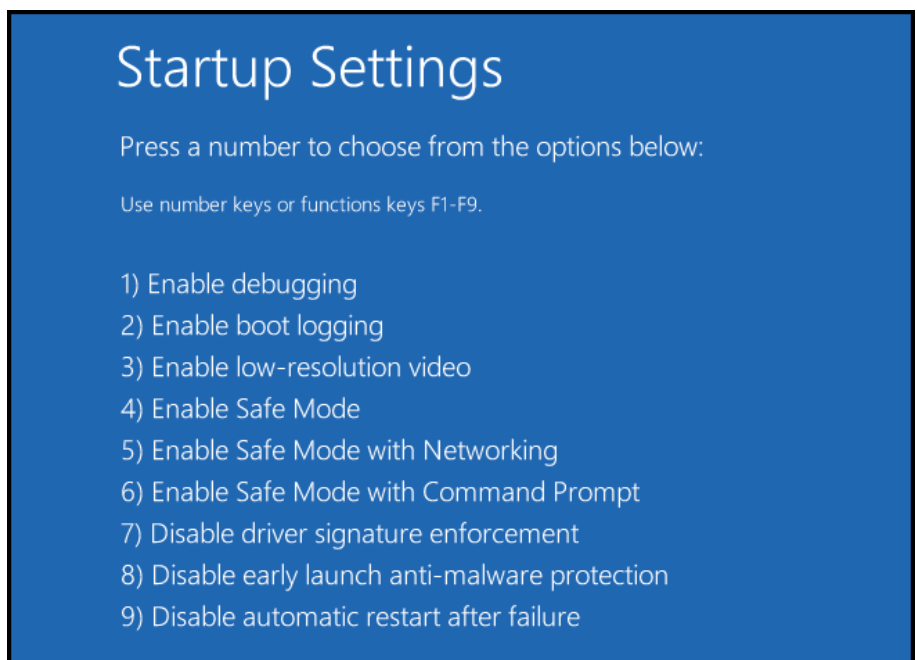

Your PC will then reboot, and you will be able to install the **OBTX** drivers without any error message.

## 7.7 Remote Commands

### 7.7.1 Overview

Remote commands are used to setup functionality on the SOL07 Transmitter. They can be sent over the RS232 control interface from any control source, application or hardware or via USB using the Domo Device Controller application.

If the packet satisfies an address and integrity check, then the controlled device will action the command and send a reply. Additional functionality checks such as licensing will limit the accepted range of some commands, either reverting to default value or turning the option off.

Control packet structure to device:

ASCII	Value	Description
STX	02h	Start byte
0123	30h-39h	4-byte unit address. In range 0001-9999
T	20h-7Eh	1-byte command type r (72h) = read status or from current configuration w (77h) = write to current configuration
ABCD	20h-7Eh	4-byte command mnemonic
;	3Bh	1-byte separator
PQR	20h-7Eh	x byte data, optional, variable length
;	3Bh	1-byte separator
X	80h-FFh	1-byte checksum
ETX	03h	End byte

Reply packet structure to device:

ASCII	Value	Description
STX	02h	Start byte
0123	30h-39h	4-byte unit address. In range 0001-9999
Z	20h-7Eh	1-byte status 1 (31h) = command received ok E (45h) = error, command could not be actioned
PQR	20h-7Eh	x byte data, optional, variable length
;	3Bh	1-byte separator

ASCII	Value	Description
X	80h-FFh	1-byte checksum
ETX	03h	End byte

The checksum is the summation of all bytes in the packet, not including the start and end bytes. An AND operation with FFh is done to discard higher order bytes. Then an OR operation is then performed with 80h to prevent emulation of special characters.

Below is an example showing how to build up a remote command packet for reading the board type:

1. Packet content based on address and required command:
  - Address of 0001... 30h 30h 30h 31h
  - Command rgbty... 72h 67h 62h 74h 79h
  - Separators no data... 3Bh 3Bh
2. Sum above bytes then AND/OR operation to generate checksum:
  - $30h + 30h + 30h + 31h + 72h + 67h + 62h + 74h + 79h + 3Bh + 3Bh = 35Fh$
  - $35Fh \text{ AND } FFh = 5Fh$
  - $5Fh \text{ OR } 80h = DFh$
3. Combine start and end bytes with content and checksum:
  - 02h 30h 30h 30h 31h 72h 67h 62h 74h 79h 3Bh 3Bh DFh 03h

Several situations could cause an error status to be returned:

- Message is incorrectly formatted (separators in wrong place or missing).
- Command mnemonic or other characters are in upper case.
- Command mnemonic does not match an available command.
- Checksum is incorrect.

Addresses in the range 0001 to 9998 are for general use. Address 0000 is reserved and 9999 is a broadcast address, i.e. any device will reply to this address. Its reply will contain its own specific address.

Reply data will be in one of the following formats dependent on the command.

Type	Description
unsigned	6-byte length. Unsigned 16-bit integer value stuffed with preceding zeros.
signed	6-byte length. Signed 16-bit integer value stuffed with preceding zeros.
string	Variable length. String excluding termination character.
hex string	8-byte length (unless otherwise stated).
float	Variable length. Reply always contains decimal point and 4 decimal places. Can have 1 to 5 digits before decimal and optional negative '-' sign.

## 7.7.2 Command List

**Note:** The command listings that follow are for the SOL07 family of transmitters that are based off the D1500 and D1600 internal PCB which are for standard definition and high definition video respectively. Most commands are shared between the two different variants but where they are specific to the HD products, these will be highlighted.

### Group: Audio

Command	Command Name	Type	R/W	Scope	Options
a1en	Audio encoder	intList		Config	2 = MPEG Layer I 3 = MPEG Layer II 5 = LPCM 16-bit
a1gl	Audio stereo/left mono analogue gain	integer		Config	dB
a1gr	Audio right mono analogue gain	integer		Config	dB
a1in	Audio source 1	intList		Config	0 = Off 1 = Unbalanced 2 = Balanced 3 = Embedded 1 4 = Embedded 2
a1mo	Audio encoder mode	intList		Config	0 = Stereo 1 = Left mono 2 = Right mono 3 = Dual mono
a1ok	Audio locked 1	intList	Read Only	Global	0 = No 1 = Yes

Command	Command Name	Type	R/W	Scope	Options																														
a2in	Audio source 2	intList		Config	0 = Off 1 = Unbalanced 2 = Balanced 3 = Embedded 1 4 = Embedded 2																														
a2ok	Audio locked 2	intList	Read Only	Global	0 = No 1 = Yes																														
a1br	MPEG audio bitrate	intList		Config	<table border="0"> <tr> <td>Layer 1</td> <td>Layer 2</td> </tr> <tr> <td>1 = 32kbps</td> <td>1 = 32kbps</td> </tr> <tr> <td>2 = 64kbps</td> <td>2 = 48kbps</td> </tr> <tr> <td>3 = 96kbps</td> <td>3 = 56kbps</td> </tr> <tr> <td>4 = 128kbps</td> <td>4 = 64kbps</td> </tr> <tr> <td>5 = 160kbps</td> <td>5 = 80kbps</td> </tr> <tr> <td>6 = 192kbps</td> <td>6 = 96kbps</td> </tr> <tr> <td>7 = 224kbps</td> <td>7 = 112kbps</td> </tr> <tr> <td>8 = 256kbps</td> <td>8 = 128kbps</td> </tr> <tr> <td>9 = 288kbps</td> <td>9 = 160kbps</td> </tr> <tr> <td>10 = 320kbps</td> <td>10 = 192kbps</td> </tr> <tr> <td>11 = 352kbps</td> <td>11 = 224kbps</td> </tr> <tr> <td>12 = 384kbps</td> <td>12 = 256kbps</td> </tr> <tr> <td>13 = 416kbps</td> <td>13 = 320kbps</td> </tr> <tr> <td>14 = 448kbps</td> <td>14 = 384kbps</td> </tr> </table>	Layer 1	Layer 2	1 = 32kbps	1 = 32kbps	2 = 64kbps	2 = 48kbps	3 = 96kbps	3 = 56kbps	4 = 128kbps	4 = 64kbps	5 = 160kbps	5 = 80kbps	6 = 192kbps	6 = 96kbps	7 = 224kbps	7 = 112kbps	8 = 256kbps	8 = 128kbps	9 = 288kbps	9 = 160kbps	10 = 320kbps	10 = 192kbps	11 = 352kbps	11 = 224kbps	12 = 384kbps	12 = 256kbps	13 = 416kbps	13 = 320kbps	14 = 448kbps	14 = 384kbps
Layer 1	Layer 2																																		
1 = 32kbps	1 = 32kbps																																		
2 = 64kbps	2 = 48kbps																																		
3 = 96kbps	3 = 56kbps																																		
4 = 128kbps	4 = 64kbps																																		
5 = 160kbps	5 = 80kbps																																		
6 = 192kbps	6 = 96kbps																																		
7 = 224kbps	7 = 112kbps																																		
8 = 256kbps	8 = 128kbps																																		
9 = 288kbps	9 = 160kbps																																		
10 = 320kbps	10 = 192kbps																																		
11 = 352kbps	11 = 224kbps																																		
12 = 384kbps	12 = 256kbps																																		
13 = 416kbps	13 = 320kbps																																		
14 = 448kbps	14 = 384kbps																																		
a1mb	Microphone power	intList		Config	0 = Off 1 = 2.0V 2 = 12.0V 3 = 48.0V																														
a1sr	Audio sample rate	intList		Config	0 = 8.000kHz 1 = 11.025kHz 2 = 12.000kHz 3 = 16.000kHz 4 = 22.050kHz 5 = 24.000kHz 6 = 32.000kHz 7 = 44.100kHz 8 = 48.000kHz																														
a1vs	Audio video sync mode	intList		Config	0 = No 1 = Yes																														
a1id	audioStreamID	integer		Config																															
a1of	Audio PTS offset	integer		Config	ms																														

### Group: Base

Command	Command Name	Type	R/W	Scope	Options
bdes	Base card description	string	Read Only	Global	String length = 61

Command	Command Name	Type	R/W	Scope	Options
buty	Base card type	integer	Read Only	Global	
bdfd	Default operating frequency	double		Global	MHz
bfrs	Minimum frequency resolution	double	Read Only	Global	MHz
brhi	High frequency restriction	double		Global	MHz
brlo	Low frequency restriction	double		Global	MHz
bedr	Base card config revision	integer	Read Only	Global	
bfhi	Maximum operating frequency	double		Global	MHz
bflo	Minimum operating frequency	double		Global	MHz
bpiq	Base card IQ calibration points	integer		Global	
bppw	Base card power calibration points	integer		Global	
btmp	Base card calibration temperature	integer	Read Only	Global	C

### Group: Camera

Command	Command Name	Type	R/W	Scope	Options
tcam	Videosys camera type	intList		Global	0 = Sony 1 = Panasonic 2 = Grass Valley LDK 3 = Ikegami 4 = Hitachi 5 = Grass Valley LDX 6 = Grass Val Bi-Dir 7 = Nac Hi-Motion 8 = Videosys 9 = Tally Only 10 = Pana Studio 11 = Panasonic EC4
tccs	Videosys camera connection status	string	Read Only	Global	String length = 20
tcid	Videosys camera number	integer		Global	
tfr2	Videosys secondary control frequency	double		Global	MHz
tfre	Videosys control frequency	double		Global	MHz
tlks	Videosys link status	string	Read Only	Global	String length = 20
tser	Videosys serial number	string	Read Only	Global	String length = 6



Command	Command Name	Type	R/W	Scope	Options
tswv	Videosys software version	string	Read Only	Global	String length = 10
ttys	Videosys tally status	string	Read Only	Global	String length = 20
tlma	Videosys license mask	hexString	Read Only	Global	
tocc	Videosys options 5600K	intList		Global	0 = Enable (Filters) 1 = Disable (ECC)
tond	Videosys options Hitachi ND	intList		Global	0 = 5 Position (Cap) 1 = 4 Position
tosc	Videosys options Sony colours	intList		Global	0 = Absolute 1 = Relative (AWB)
totm	Videosys options tally mode	intList		Global	0 = Standard 1 = Force Record
tlic	Videosys license key	string		Global	String length = 25

### Group: Data

Command	Command Name	Type	R/W	Scope	Options
d1ba	Data baud	intList		Config	0 = 1200 1 = 2400 2 = 4800 3 = 9600 4 = 19200 5 = 38400 6 = 57600 7 = 115200
d1fo	Data format	intList		Config	1 = 8b None 2 = 8b Even 3 = 8b Odd 5 = 7b None 6 = 7b Even 7 = 7b Odd
d1in	Data input	intList		Config	0 = Off 1 = On
d1mo	Data mode	intList		Config	0 = Low bitrate 1 = Low latency
d1ty	Data packet type	intList		Config	0 = Mode 1 1 = Mode 2

## Group: DVB-T Mod

Command	Command Name	Type	R/W	Scope	Options
o1ba	DVB-T bandwidth	intList		Config	0 = 6MHz 1 = 7MHz 2 = 8MHz
o1co	DVB-T constellation	intList		Config	0 = QPSK 1 = 16-QAM 2 = 64-QAM
o1fe	DVB-T FEC rate	intList		Config	0 = 1/2 1 = 2/3 2 = 3/4 3 = 5/6 4 = 7/8
o1gu	DVB-T guard interval	intList		Config	0 = 1/32 1 = 1/16 2 = 1/8 3 = 1/4
o14k	DVB-T 4k offset	intList		Config	0 = None 1 = +4kHz 2 = -4kHz
o1dp	DVB-T dual pedestal	intList		Config	0 = No 1 = Yes
o1sp	DVB-T spectrum polarity	intList		Config	0 = Norm 1 = Inv

## Group: Misc

Command	Command Name	Type	R/W	Scope	Options
mpat	Pattern generator control	intList		Config	0 = Disabled 1 = Force on 2 = Auto video/audio 3 = Auto video 4 = Auto audio 5 = AV sync
mgrp	SDI embedded audio group	intList		Config	0 = 1(0xFF/0xE7) 1 = 2(0xFD/0xE6) 2 = 3(0xFB/0xE5) 3 = 4(0xF9/0xE4)

Command	Command Name	Type	R/W	Scope	Options
mpmo	Pattern generator mode	intList		Config	0 = Black screen 1 = Blue screen 2 = Green screen 3 = Cyan screen 4 = Red screen 5 = Magenta screen 6 = Yellow screen 7 = White screen 8 = Static pattern 9 = Moving pattern
mspl	SDI 3G-B payload select	intList		Config	0 = Automatic 1 = Force payload 1 2 = Force payload 2
msid	Miscellaneous stream ID	integer		Config	

### Group: Narrowband Mod

Command	Command Name	Type	R/W	Scope	Options
onba	NB / UMVL bandwidth	intList		Config	0 = 6MHz 1 = 7MHz 2 = 8MHz 3 = 2.5MHz 4 = 1.25MHz 5 = 625kHz
onco	NB / UMVL constellation	intList		Config	0 = QPSK 1 = 16-QAM 2 = BPSK 3 = 8PSK
onfe	NB / UMVL FEC rate	intList		Config	1 = 2/3 2 = 1/3
ongu	NB / UMVL guard interval	intList		Config	1 = 1/16 2 = 1/8
onrm	NB range mode mask	integer		Config	
onsp	NB / UMVL spectrum polarity	intList		Config	0 = Norm 1 = Inv

## Group: RF

Command	Command Name	Type	R/W	Scope	Options
ofre	Modulation frequency	double		Config	MHz
oout	Modulation output	intList		Config	0 = Off 1 = On
opow	Output power	intList		Config	0 = 10mW 1 = 50mW 2 = 100mW 3 = 200mW 4 = 500mW 5 = 1W 6 = 2W 7 = 5W
oppa	Additional PA power	intList		Config	0 = None 1 = 500mW 2 = 1W 3 = 2W 4 = 5W
osch	Modulation scheme	intList		Config	0 = NB / UML 1 = DVB-T
olev	Output attenuation	double		Config	dB
olin	Linearity mode	intList		Config	0 = Low power 1 = High linearity
oprd	Range mode description	string	Read Only	Global	String length = 21
oprm	Range mode	integer		Config	
oprc	Range mode count	integer		Global	

## Group: Scram

Command	Command Name	Type	R/W	Scope	Options
zscr	Encryption mode	intList		Config	0 = Off 1 = ABS 4 = AES128 6 = AES256 8 = BCrypt128 10 = BCrypt256 12 = CCrypt128 14 = CCrypt256 18 = ADL256
zkey	AES encryption key 2	hexString	Write Only	Config	
zkey	ABS encryption key	hexString	Write Only	Config	

Command	Command Name	Type	R/W	Scope	Options
zkez	AES encryption key 1	hexString	Write Only	Config	
zask	ADL session key	string	Write Only	Global	String length = 125

### Group: Service

Command	Command Name	Type	R/W	Scope	Options
pmbs	Current mux bitrate	double	Read Only	Global	Mbps
pmet	Transmitter metadata	intList		Config	0 = Off 1 = On
prno	Program number	integer		Config	
psa1	Current audio 1 PID	integer	Read Only	Global	
psa2	Current audio 2 PID	integer	Read Only	Global	
pscr	Current PCR PID	integer	Read Only	Global	
psd1	Current data PID	integer	Read Only	Global	
psmd	Current metadata PID	integer	Read Only	Global	
psmt	Current PMT PID	integer	Read Only	Global	
psv1	Current video PID	integer	Read Only	Global	
psva	Current ANC 1 PID	integer	Read Only	Global	
pchi	Chaining input	intList		Config	0 = Off 1 = On 2 = Relay
pcho	Chaining output	intList		Config	0 = Off 1 = On
pchs	Chaining status	intList	Read Only	Global	0 = Off 1 = On 2 = Overflow1 3 = Overflow2
pmbr	Manual mux bitrate	double		Config	Mbps
pnam	Service name	string		Config	String length = 12
ppa1	Manual audio 1 PID	integer		Config	
ppa2	Manual audio 2 PID	integer		Config	
ppcr	Manual PCR PID	integer		Config	
ppd1	Manual data PID	integer		Config	
ppmd	Manual metadata PID	integer		Config	

Command	Command Name	Type	R/W	Scope	Options
ppmt	Manual PMT PID	integer		Config	
ppv1	Manual video PID	integer		Config	
ppva	Manual ANC 1 PID	integer		Config	
pdmt	Delay PMT update	integer		Config	s

### Group: Unit

Command	Command Name	Type	R/W	Scope	Options
gdef	Restore defaults	intList	Write Only	Global	0 = No 1 = Yes
gfpg	FPGA version number	string	Read Only	Global	String length = 8
glod	Current config	intList		Memory	0 = Current 1-16 = 1-16
gser	Electronic serial number	string	Read Only	Global	String length = 8
gtmp	Board temperature	integer	Read Only	Global	C
gvba	Battery voltage	double	Read Only	Global	V
gver	Software version number	string	Read Only	Global	String length = 10
gdlc	Initiate code download	integer	Write Only	Global	
gdsl	Disable status LEDs	intList		Global	0 = No 1 = Yes
gdtc	Disable temperature compensation	intList		Global	0 = No 1 = Yes
glma	License mask	hexString	Read Only	Global	
gmax	Number of configurations	integer		Global	
gnet	Network name	string		Global	String length = 12
grst	Remote reset	integer	Write Only	Global	
gsle	Operational state	intList		Global	0 = Active 1 = Standby 2 = Sleep

Command	Command Name	Type	R/W	Scope	Options
gvex	External voltage reading	double	Write Only	Global	V
<b>gvi0</b>	Internal voltage reading 0	double	Read Only	Global	V
<b>gvi1</b>	Internal voltage reading 1	double	Read Only	Global	V
<b>gvi2</b>	Internal voltage reading 2	double	Read Only	Global	V
gadd	Control address	integer		Global	
gbty	Board type	string	Read Only	Global	String length = 5
gety	Expansion card type	integer	Read Only	Global	
glic	License code	string	Write Only	Global	String length = 72
gstd	Set unit time and date	string	Write Only	Global	String length = 19
guty	Unit type	intList		Global	1 = OEM 2 = SOL7NTX <b>2 = SOL7HDNTX</b> 3 = SOL7DCAM <b>3 = SOL7HDDCAM</b> 4 = NETWorkerHUB <b>4 = Invalid Option</b> 5 = SOL7NTX500 <b>5 = Invalid Option</b> 6 = SOL7NTX1000 <b>6 = Invalid Option</b> 7 = SOL7JAF1000 <b>7 = Invalid Option</b> 8 = SOL7ADL <b>8 = SOL7HDADL</b> 9 = Invalid Option <b>9 = SOL7OBTX</b> 11 = SOL7TX <b>11 = Invalid Option</b> <b>12 = SOL7BNTX</b>

## Group: Video

Command	Command Name	Type	R/W	Scope	Options
v1ae	ANC Encoder Enable	intList		Config	0 = Off 1 = On
v1ar	Current ANC bitrate	double	Read Only	Global	Mbps
v1bs	Current video bitrate	double	Read Only	Global	Mbps
v1en	Video encoder	intList		Config	1 = MPEG4 ASP 2 = MPEG4 H.264
v1fo	Video source format	intList		Config	0 = Automatic 1 = PAL 2 = NTSC 3 = NTSC NP 4 = 720p50 5 = 720p59 6 = 720p60 7 = 1080i50 8 = 1080i59 9 = 1080i60 10 = 1080p23 11 = 1080p24 12 = 1080p25 13 = 1080p29 14 = 1080p30 15 = 1080psf23 16 = 1080psf24 17 = 1080psf25 18 = 1080psf29 19 = 1080psf30 20 = 1080p50 21 = 1080p59 22 = 1080p60 23 = 1080dl50 24 = 1080dl59 25 = 1080dl60
v1in	Video source	intList		Config	0 = Off 1 = Composite 1 2 = Composite 2 3 = S-Video 4 = SDI 5 = HDMI
v1ok	Video locked	intList	Read Only	Global	0 = No 1 = Yes
v1br	Manual video bitrate	double		Config	Mbps
v1db	H.264 de-blocking filter	intList		Config	0 = Off 1 = On



Command	Command Name	Type	R/W	Scope	Options
v1de	De-interlace video source	intList		Config	0 = No 1 = Yes
v1hb	Video OSD heartbeat	intList		Config	0 = Off 1 = On
v1mo	Video encoder mode	intList		Config	0 = Standard delay 1 = Low delay 2 = Ultra low delay
v1os	Video OSD position	intList		Global	0 = Off 1 = Top Left 2 = Top Centre 3 = Top Right 4 = Centred 5 = Bottom Left 6 = Bottom Centre 7 = Bottom Right
v1pe	Video PES per frame	intList		Config	0 = No 1 = Yes
v1pr	H.264 encoder profile	intList		Config	0 = Baseline 1 = Main 2 = High (4:2:0) 3 = High (4:0:0) 4 = High (4:2:2)
v1qd	Video quality description	string	Read Only	Global	String length = 21
v1qm	Video quality mode	integer		Config	
v1rp	GOP length	integer		Config	frames
v1sf	Sub frame rate	intList		Config	0 = Full 1 = 1/2 2 = 1/4 3 = 1/8 4 = 1/24
v1sh	Sub horizontal resolution	intList		Config	0 = Full 1 = 3/4 2 = 2/3 3 = 1/2 4 = 1/4
v1sv	Sub vertical resolution	intList		Config	0 = Full 1 = 1/2 2 = 1/4
v1ab	Video bitrate scalar	integer		Global	
v1id	Video stream ID	integer		Config	

<b>Command</b>	<b>Command Name</b>	<b>Type</b>	<b>R/W</b>	<b>Scope</b>	<b>Options</b>
v1of	Video PTS offset	integer		Config	ms
v1qp	Video fixed QP	integer		Global	

## 8. Appendix B – After-Sales Support

### 8.1 Documentation and Software

It is DTC's practise to make the majority of our latest user guides and software available to customers online, by using our WatchDox facility. To access this site, please contact your Account Manager or send a request to [solent.support@domotactical.com](mailto:solent.support@domotactical.com).

You will be sent a link where you can log in and create your own password followed by a confirmation email. Once you have done this, you can then log in to your account.

### 8.2 Contact Technical Support

The Technical Support team can be accessed by one of the following:

- **Post:** DTC – Solent, Fusion 2, 110 Parkway, Solent Business Park, Whiteley, Hampshire, PO15 7AB, England
- **Phone:** +44 1489 884 550. Office hours: 0900-1700 UK time excluding holidays
- **Email:** [solent.support@domotactical.com](mailto:solent.support@domotactical.com) (no restricted content)

### 8.3 Using the DTC RMA Service

If there is a problem and all troubleshooting steps have been unsuccessful, you may need to contact DTC for Return Material Authorisation (RMA) service.

#### 8.3.1 Contact DTC

Please call our Technical Support Line on +44 (0) 1489 884550. If this has been done and the issue cannot be resolved, email [solent.customerhub@domotactical.com](mailto:solent.customerhub@domotactical.com) to request an RMA form.

#### 8.3.2 Complete and Return the RMA Form

Complete the RMA form with the following information and return to the customer hub:

- Name
- Address
- Unit serial number
- Date of purchase or the original invoice number
- Date of failure
- A detailed description of the problems you have encountered
- A list of the hardware/software configuration if applicable

Once the hub receive the complete form, we will then send an RMA number and shipping instructions.

### 8.3.3 Pack the Device

**Note:** Before packing, remove all personal non-DTC kit or media from the device.

Use the original shipping container and packing materials, if possible.

If the original packing materials are not available, wrap the equipment with soft material (e.g. PU/PE form) then put the wrapped equipment into a hard cardboard shipping box.

### 8.3.4 Put the RMA Number on the Box

Clearly mark the outside of the shipping box with the RMA number. If an RMA number is not present on the shipping box, receiving will be unable to identify it and it might be returned.

### 8.3.5 Send the Box to DTC

Send the box using your normal shipping process.

## 9. Appendix C – Safety and Maintenance

### 9.1 Cautions and Warnings

**Note:** The following guidelines may or may not be applicable to your product. However, we would ask that you read them to assess their relevance.

Area	Note
Aircraft Safety	<p>Use of this equipment on board aircraft is strictly forbidden, unless confirmed as safe by the aircraft operator.</p> <p>Use of radio transmitter equipment in an aircraft can endanger navigation and other systems.</p>
Cables	Connecting cables should not be positioned where they are likely to become damaged or where they may present a trip hazard.
Electrostatic Discharge	ESD guidelines must be followed for this electrostatic sensitive device.
Enclosures	<p>Do not remove any factory installed screws or fastenings. Damage to the units may result and void any warranties.</p> <p>Only authorised, trained personnel should open the product. There are no functions that required the user to gain access to the interior of the product. There are no user serviceable parts inside.</p>
Environment	The equipment should not be used in hazardous or corrosive atmospheres. Users are reminded of the necessity of complying with restrictions regarding the use of radio devices in fuel depots, chemical plants and locations where explosives are stored and/or used.
Lightning Strike	There is a risk of lightning strike to antennas. The equipment should not be assembled in an area at the time of lightning activity. Antennas should be adequately protected from lightning strikes.
Power Supply	Ensure that the power supply arrangements are adequate to meet the stated requirements of each product. Observe all electrical safety precautions.
RF Emissions	<p>When wearing the Nano Transmitter on the body, you must only put the side with the label and the mounting lugs towards your body.</p> <p>The transmitter must always be mounted at a minimum of 5mm away from your body.</p> <p>The antenna must be kept vertical when the transmitter is mounted near to the body.</p> <p>The device is operating on an FCC Part 90 frequency.</p>
Risk of Eye Injury	Care should be taken to avoid eye contact with the antennas.

Area	Note
Thermal Control	<p>If you operate this device in an enclosed space, you must ensure it has adequate airflow to keep it cool.</p> <p>If worn close to the body, care must be taken to protect the operator from excessive temperatures.</p>
Working at Height	<p>Observe caution when locating the device at height, for example on a mast. Ensure the unit is well secured to prevent it falling and injuring personnel.</p>

## 9.2 Repairs and Alterations

Attempted repairs, alterations, improper installations or connections may invalidate the warranty. Please contact Technical Support if you suspect a faulty or defective component. See *Section 8.2*.

## 9.3 Caring for your Equipment

- Do not subject the unit to physical abuse, excessive shock or vibration
- Do not drop, jar or throw the unit
- Do not carry the unit by the antenna
- Avoid exposure to excessive moisture or liquids
- Do not submerge the unit unless it is designed to be submersible
- Do not expose the unit to corrosives, solvents, cleaners or mineral spirits
- Avoid exposure to excessive cold and heat
- Avoid prolonged exposure to direct sunlight
- Do not place or leave units on surfaces that are unstable
- Only use accessories intended for the specific make and model of your unit, especially batteries, chargers and power adapters.

## 9.4 Charging

- Use approved batteries, chargers and adapters designed specifically for your make and model unit
- Do not attempt to charge a wet unit or battery pack
- Do not charge the unit or battery pack near anything flammable
- Stabilize the battery pack to room temperature (22°C) before charging
- Do not charge units and/or battery packs on wet or unstable surfaces
- Do not leave units and/or batteries in chargers for excessive periods

## 9.5 Working with Lithium Batteries

- Charge only with the approved charging cable
- Batteries are to be used only for the specified purpose. Incorrect use will invalidate the warranty and may make the battery become dangerous.
- Charge in a clean, dry environment ideally at 10°C (0 to 45°C is permissible).
- Do not store or operate in direct sunlight for extended periods. Battery can be damaged by over-heating, for example if placed on the rear parcel shelf of a motor vehicle.
- Store in a cool dry environment. Storage at elevated temperatures can cause permanent loss of capacity.
- For short term storage (less than six months), store in a fully charged state.
- For extended periods of storage (more than one year), charge before storage and recharge every six to nine months.
- Always fully recharge the battery after any storage period greater than one month before use.
- Do not store the battery with the charge depleted as this can cause failure of the battery and invalidate warranty.
- Do not short circuit
- Do not immerse in water
- Do not incinerate. Cells are likely to explode if placed in a fire.
- Dispose of batteries in accordance with the regulations in place for the country of use. Batteries are normally considered separate waste and should not be allowed to enter the normal waste stream. Either return to the seller or deliver to an approved re-cycling facility.

## 9.6 Cleaning

- Turn off the unit and remove batteries (if applicable) before maintenance
- Use a clean, soft, damp cloth to clean the unit. A microfiber cloth is recommended.
- Do not use alcohol or cleaning solutions to clean the unit
- Do not immerse the unit in water to clean it
- If the unit becomes wet, immediately dry it with a microfiber or other lint-free cloth

## 9.7 Storage

- Turn off the unit and remove batteries before storage
- Store units and battery packs in a cool, dry area at room temperature (22°C)
- Do not store units and/or batteries in active chargers

## 10. Appendix D – Glossary

A	Definition
AES	Advanced Encryption Standard. Originally published as Rijndael, this specification has been adopted by the U.S. government. Each AES cipher has a 128-bit block size, with key sizes of 128 and 256 bits, respectively.
ASI	Asynchronous Serial Interface is a streaming data interface that often carries an MPEG Transport Stream.  An ASI signal can carry one or multiple SD, HD or audio programs that are already compressed, not like an uncompressed SD-SDI (270Mbps) or HD-SDI (1.45Gbps). An ASI signal can carry varying amounts of data but is always padded to run at a fixed line rate of 270Mbps.
Antenna Gain	Antenna gain is a measure of how well an antenna converts power into radio waves or radio waves into power, depending on whether it is fitted to a transmitter or receiver device.  Antenna gain is expressed in dB (decibels).

B	Definition
Bandwidth	RF – the width of a band of frequencies used for a particular purpose.  Computing – the rate of data transfer measured in bit/s.

C	Definition
COFDM	Coded Orthogonal Frequency Division Multiplexing is a frequency-division multiplexing (FDM) scheme utilized as a digital multi-carrier modulation method. A large number of closely spaced orthogonal sub-carriers are used to carry data.

D	Definition
Decibel (dB)	The standard unit used to express transmission gain or loss and relative power levels.
Decoder	A processor in a receiver that converts compressed digital video or audio data to a format suitable for monitoring.
Demodulate	To recover the information originally impressed on the radio wave.
Downconverter	A device that converts microwave frequencies to UHF frequencies for use in DTC receivers.



<b>E</b>	<b>Definition</b>
Elementary Stream	These streams contain only one MPEG video or audio channel. Elementary streams are required if you intend to use Milestone or any player that cannot operate with transport streams.
Encoder	A processor in a transmitter that converts video or audio to compressed digital signals.

<b>F</b>	<b>Definition</b>
FEC	Forward Error Correction is a system of error control for data transmission, whereby the sender adds redundant data to its messages. This allows the receiver to detect and correct errors without the need to ask the sender for additional data.
FPGA	A Field-Programmable Gate Array is an integrated circuit that can be programmed to perform complex logic functions.

<b>G</b>	<b>Definition</b>
Gain	An increase in signal strength, typically by an amplifier.
GUI	A Graphical User Interface allows users to interact with an electronic device.

<b>I</b>	<b>Definition</b>
IP address	An Internet Protocol address is a unique numeric ID for a device within a network.

<b>L</b>	<b>Definition</b>
LOS	Line-of-sight propagation refers to RF transmissions that travel in a direct path from transmitter to receiver.

<b>M</b>	<b>Definition</b>
MPEG	Moving Pictures Experts Group is an organisation that sets the standards for audio and video compression and transmission.
Modulation	To change the output of a transmitter in amplitude, phase or frequency in accordance with the information to be transmitted. Data is superimposed on a carrier current or wave by means of a process called modulation.
Multicast	Multicasting is sending data from a sender to multiple receivers where each receiver signals that they want to receive the data.

<b>N</b>	<b>Definition</b>
NLOS	Non-line-of-sight propagation refers to RF transmissions that travel in a path obstructed by physical objects.
NTSC	National Television Systems Committee is the analogue television system used mainly, but not exclusively, in the Americas.
Noise	Unwanted disturbance in an electrical signal.

<b>O</b>	<b>Definition</b>
Omnidirectional antenna	An antenna whose radiation pattern shows equal radiation in all horizontal directions.

<b>P</b>	<b>Definition</b>
PAL	Phase Alternate Line is the analogue television system used mainly, but not exclusively, throughout the world (see NTSC).
PTZ	Pan-tilt-zoom is a common way of referring to controllable cameras.

<b>Q</b>	<b>Definition</b>
QAM	Quadrature Amplitude Modulation. DTC products commonly use either the 16 state (16-QAM) or 64 state (64-QAM) modulation schemes
QPSK	Quadrature Phase Shift Keying digital modulation scheme.

<b>R</b>	<b>Definition</b>
RTSP	Real Time Streaming Protocol is a network control protocol designed for the transfer of real-time media data. The protocol is used for establishing and controlling media sessions between end points.

<b>S</b>	<b>Definition</b>
SDI	Serial Digital Interface is a standard used for the transmission of uncompressed digital video signals, often including embedded audio.
SNR	Signal to Noise Ratio is an electrical engineering measurement defined as the ratio of wanted signal power to the corrupting noise power.  The higher the ratio, the less obtrusive the background noise is.
Streaming	Streaming is the transmission of digital media over an IP network.

<b>T</b>	<b>Definition</b>
Transport Stream	A standard digital container format for transmission and storage of audio, video, and Program and System Information Protocol (PSIP) data.  Channels are multiplexed together, allowing the receiver to choose which to play back.

<b>U</b>	<b>Definition</b>
UDP	User Datagram Protocol is a core of the Internet Protocol suite. UDP does not employ reliability mechanisms, therefore, if the receiver does not get a packet, the sender will never know. However, UDP is very efficient when there is little chance of errors.
USB	Universal Serial Bus defines the cables, connectors and protocols used in electronic bus connections.
Unicast	Unicast is simply sending packets from one source to one destination.

<b>V</b>	<b>Definition</b>
Viterbi Decoder	A Viterbi decoder uses the Viterbi algorithm for decoding a bit stream that has been encoded using forward error correction based on a convolutional code.