

## ODIN OMNEO Digital Intercom

*up to and including version 1.1.0*



**PROPRIETARY NOTICE**

The product information and design disclosed herein were originated by and are the property of Bosch Security Systems, Inc. Bosch reserves all patent, proprietary design, manufacturing, reproduction, use and sales rights thereto, and to any article disclosed therein, except to the extent rights are expressly granted to others.

**COPYRIGHT NOTICE**

Copyright 2019 by Bosch Security Systems, Inc. All rights reserved. Reproduction, in whole or in part, without prior written permission from Bosch is prohibited.

\*All other trademarks are property of their respective owners.

**WARRANTY AND SERVICE INFORMATION**

For warranty and service information, refer to the appropriate web site below:

RTS Intercoms ..... [www.rtsintercoms.com/warranty](http://www.rtsintercoms.com/warranty)  
 RTS Digital  
 RTSTW  
 AudioCom  
 RadioCom  
 Intercom Headsets

**CUSTOMER SUPPORT**

Technical questions should be directed to:

Customer Service Department  
 Bosch Security Systems, Inc.  
[www.rtsintercoms.com](http://www.rtsintercoms.com)



**TECHNICAL QUESTIONS**

Bosch Security Systems Technical Support

[http://www.rtsintercoms.com/contact\\_main.php](http://www.rtsintercoms.com/contact_main.php)

**DISCLAIMER**

The manufacturer of the equipment described herein makes no expressed or implied warranty with respect to anything contained in this manual and shall not be held liable for any implied warranties of fitness for a particular application or for any indirect, special, or consequential damages. The information contained herein is subject to change without prior notice and shall not be construed as an expressed or implied commitment on the part of the manufacturer.

	<p><b>CAUTION</b></p> <p>RISK OF ELECTRIC SHOCK DO NOT OPEN</p>	
<p>THE LIGHTNING FLASH AND ARROWHEAD WITHIN THE TRIANGLE IS A WARNING SIGN ALERTING YOU OF "DANGEROUS VOLTAGE" INSIDE THE PRODUCT.</p>	<p>CAUTION: TO REDUCE THE RISK OF ELECTRIC SHOCK, DO NOT REMOVE COVER. NO USER-SERVICEABLE PARTS INSIDE. REFER SERVICING TO QUALIFIED SERVICE PERSONNEL.</p>	<p>THE EXCLAMATION POINT WITHIN THE TRIANGLE IS A WARNING SIGN ALERTING YOU OF IMPORTANT INSTRUCTIONS ACCOMPANYING THE PRODUCT.</p>
<p>SEE MARKING ON BOTTOM/BACK OF PRODUCT.</p>		

**WARNING:** APPARATUS SHALL NOT BE EXPOSED TO DRIPPING OR SPLASHING AND NO OBJECTS FILLED WITH LIQUIDS, SUCH AS VASES, SHALL BE PLACED ON THE APPARATUS.

**WARNING:** THE MAIN POWER PLUG MUST REMAIN READILY OPERABLE.

**CAUTION:** TO REDUCE THE RISK OF ELECTRIC SHOCK, GROUNDING OF THE CENTER PIN OF THIS PLUG MUST BE MAINTAINED.

**WARNING:** TO REDUCE THE RISK OF FIRE OR ELECTRIC SHOCK, DO NOT EXPOSE THIS APPARATUS TO RAIN OR MOISTURE.

**WARNING:** TO PREVENT INJURY, THIS APPARATUS MUST BE SECURELY ATTACHED TO THE FLOOR/WALL/RACK IN ACCORDANCE WITH THE INSTALLATION INSTRUCTIONS.

	<p>This product is AC only.</p>
---	---------------------------------

	
---	--

**WARNING:** THIS IS A CLASS A PRODUCT. IN A DOMESTIC ENVIRONMENT THIS PRODUCT MAY CAUSE RADIO INTERFERENCE, IN WHICH CASE THE USER MAY BE REQUIRED TO TAKE ADEQUATE MEASURES.

---

## *Important Safety Instructions*

1. Read these instructions.
2. Keep these instructions.
3. Heed all warnings.
4. Follow all instructions.
5. Do not use this apparatus near water.
6. Clean only with dry cloth.
7. Do not block any ventilation openings. Install in accordance with the manufacturer's instructions.
8. Do not install near any heat sources such as radiators, heat registers, stoves, or other apparatus (including amplifiers) that produce heat.
9. Do not defeat the safety purpose of the polarized or grounding-type plug. A polarized plug has two blades with one wider than the other. A grounding type plug has two blades and a third grounding prong. The wide blade or the third prong are provided for your safety. If the provided plug does not fit into your outlet, consult an electrician for replacement of the obsolete outlet.
10. Protect the power cord from being walked on or pinched particularly at plugs, convenience receptacles, and the point where they exit from the apparatus.
11. Only use attachments/accessories specified by the manufacturer.
12. Use only with the cart, stand, tripod, bracket, or table specified by the manufacturer, or sold with the apparatus. When a cart is used, use caution when moving the cart/apparatus combination to avoid injury from tip-over.
13. Unplug this apparatus during lightning storms or when unused for long periods of time.
14. Refer all servicing to qualified service personnel. Servicing is required when the apparatus has been damaged in any way, such as power-supply cord or plug is damaged, liquid has been spilled or objects have fallen into the apparatus, the apparatus has been exposed to rain or moisture, does not operate normally, or has been dropped.



---

# *Table*

# *of*

# *Contents*

---

<b>INTRODUCTION</b> .....	<b>9</b>
Features .....	9
Reference View – ODIN Front Panel .....	10
Reference View – ODIN Rear Panel .....	11
Specifications .....	12
Connections .....	14
Connector Pinouts .....	14
Licensing .....	16
ODIN System Descriptions .....	16
Single-Frame System .....	16
Multi-Frame System .....	17
 <b>BASIC OPERATION</b> .....	 <b>19</b>
Navigating the Menu .....	19
Editing Form Data .....	20
ODIN Icon and Menu Descriptions .....	22
Front Panel Overview and Operation .....	33
Management Port .....	33
Front Panel LEDs .....	33
Port Status Overview .....	34
Link Status Overview .....	35
Ethernet .....	35
IFL/F2F .....	36
Misc. ....	37
Intercom Port Allocation .....	38
IFL Inter-Frame Linking (Multi-Frame Only) .....	41
Frame Mapping (Multi-Frame Only) .....	48
RSTP .....	50
 <b>INSTALLATION AND MAINTENANCE</b> .....	 <b>51</b>
Introduction .....	51
Requirements .....	51

Network Port Cabling .....	52
Network Port Configuration .....	52
Intercom Configuration .....	55
Rack Mounting Instructions .....	65
GPIO 24-Position Terminal Block Connector .....	68
Fan Tray .....	69
<b><i>FIRMWARE</i></b> .....	<b>73</b>
Download Firmware .....	73
Download a Splash Screen, Screen Saver or Licenses .....	77
Request Frame Identification .....	78
<b><i>MENU SYSTEM DESCRIPTION</i></b> .....	<b>81</b>
Main Menu Access .....	81
Status Menu .....	82
System Menu .....	82
ODIN Versions .....	82
AZedit Sessions .....	83
IPedit Sessions .....	83
Network Menu .....	84
Control Port .....	84
OMNEO (SFP) .....	85
OMNEO (RJ-45) .....	87
RVON .....	88
Management Port .....	89
Ports .....	90
OMNEO .....	90
RVON .....	91
AIO .....	93
2-Wire .....	94
Keypanel .....	95
TIF .....	96
Peripherals Menu .....	97
Trunk Master .....	97
GPIO-16 .....	99
LCP-102 .....	100
PAP-32 .....	101
PAP-5032 .....	102
Intercom Menu .....	103
GPIO .....	103
Crosspoint Inspect .....	104
Frame to Frame (Multi-frame Only) .....	105
IFL .....	107
Primary/Secondary Uplink/Downlink .....	108
Hardware Menu .....	110
Power Supplies .....	110
Cooling Fans .....	111
Temperatures .....	112
Clock .....	113
Configuration Menu .....	114

System Menu .....	114
Add Frames.....	120
Remove Frames .....	122
Split Intercom .....	123
Frame Mapping Table .....	124
Port Allocation Table.....	125
Intercom Name .....	126
Network Menu.....	127
Control Port .....	127
OMNEO.....	128
RVON.....	129
Management Port.....	129
Ports Menu.....	130
OMNEO Channels.....	130
RVON Channels .....	131
2-Wire Ports.....	132
Peripherals Menu.....	133
Trunk Master .....	133
GPIO-16.....	134
Authentication Menu .....	135
AZedit.....	135
IPedit.....	136
Front Panel.....	137
Management Port.....	138
Debug Shell .....	138
User Interface Menu .....	139
LCD Brightness .....	139
Screen Saver .....	139
Alpha Size.....	140
Keypad.....	141
Options.....	142
Advanced Menu.....	143
DHCP Server .....	143
SNMP .....	144
Clock Select.....	146
Soft Reset.....	146
Intercom Setup Menu .....	147
Stored Setups Menu (Single Frame Only).....	147
Slot 1 through Slot 4.....	148
Keypanels Menu .....	151
Key Assignments.....	151
Setup Pages.....	152
Scroll Enables .....	153
Resources Menu .....	153
Party Line .....	153
IFB .....	154
Special List .....	155
Relay.....	156
ISO.....	157
Gains Menu.....	158
I/O.....	158

---

Crosspoint.....	159
Party Line .....	159
Alphas Menu.....	160
Alphas.....	160
Alarms Menu .....	162
Unacknowledged .....	162
Active.....	163
Notes .....	165



---

# List of Figures

---

FIGURE 1.	ODIN Front Panel .....	10
FIGURE 2.	ODIN Rear Panel .....	11
FIGURE 3.	Single-Frame System .....	16
FIGURE 4.	Multi-Frame System .....	17
FIGURE 5.	ODIN Keypad and Encoders .....	19
FIGURE 6.	Front Panel LEDs .....	33
FIGURE 7.	Port Status Screen .....	34
FIGURE 8.	Link Status Overview .....	35
FIGURE 9.	Fan Tray Side Panel of ODIN .....	69
FIGURE 10.	ODIN Home .....	81
FIGURE 11.	Status Menu Icons .....	82
FIGURE 12.	Status   System Menu Items .....	82
FIGURE 13.	Status   System   ODIN Versions .....	82
FIGURE 14.	Status   System   AZedit Sessions .....	83
FIGURE 15.	Status   System   IPedit Sessions .....	83
FIGURE 16.	Status   Network Menu Icons .....	84
FIGURE 17.	Status   Network   Control Port .....	84
FIGURE 18.	Status   Network   OMNEO (SFP) .....	85
FIGURE 19.	Status   Network   OMNEO (RJ-45) .....	87
FIGURE 20.	Status   Network   RVON .....	88
FIGURE 21.	Status   Network   Management Port .....	89
FIGURE 22.	Status   Ports Menu Icons .....	90
FIGURE 23.	Status   Ports   OMNEO .....	90
FIGURE 24.	Status   Ports   RVON .....	91
FIGURE 25.	Status   Ports   AIO .....	93
FIGURE 26.	Status   Ports   2-Wire .....	94
FIGURE 27.	Status   Ports   Keypanel .....	95
FIGURE 28.	Status   Ports   TIF .....	96
FIGURE 29.	Status   Peripherals Menu Icons .....	97
FIGURE 30.	Status   Peripherals   Trunk Master .....	97
FIGURE 31.	Status   Peripherals   GPIO-16 .....	99
FIGURE 32.	Status   Peripherals   LCP-102 .....	100
FIGURE 33.	Status   Peripherals   PAP-32 .....	101
FIGURE 34.	Status   Peripherals   PAP-5032 .....	102
FIGURE 35.	Status   Intercom Menu .....	103
FIGURE 36.	Status   Intercom   GPIO .....	103
FIGURE 37.	Status   Intercom   Crosspoint Inspect .....	104
FIGURE 38.	Status   Intercom   Frame to Frame .....	105
FIGURE 39.	Status   Intercom   IFL .....	107
FIGURE 40.	Status   Hardware Menu .....	110

FIGURE 41.	Status   Hardware   Power Supplies .....	110
FIGURE 42.	Status   Hardware   Cooling Fans .....	111
FIGURE 43.	Status   Hardware   Temperatures .....	112
FIGURE 44.	Status   Hardware   Clock .....	113
FIGURE 45.	Configuration Menu Icons .....	114
FIGURE 46.	Configuration   System Menu Icons .....	114
FIGURE 47.	Configuration   System   Intercom Size Menu Icons (Multi-Frame System) .....	115
FIGURE 48.	Configuration   System   Intercom Size Menu Icons (Single Frame System) .....	115
FIGURE 49.	Configuration   System   Intercom Size   Reconfigure .....	116
FIGURE 50.	Configuration   System   Intercom Size   Add Frames .....	120
FIGURE 51.	Remove Frame Verification Message .....	122
FIGURE 52.	Split Frames Popup Message .....	123
FIGURE 53.	Configuration   System   Frame Mapping Table .....	124
FIGURE 54.	Configuration   System   Port Allocation Table .....	125
FIGURE 55.	Configuration   System   Intercom Name Display .....	126
FIGURE 56.	Configuration   Network Menu Icons .....	127
FIGURE 57.	Configuration   Network   Control Port .....	127
FIGURE 58.	Configuration   Network   OMNEO .....	128
FIGURE 59.	Configuration   Network   RVON .....	129
FIGURE 60.	Configuration   Network   Management Port .....	129
FIGURE 61.	Configuration   Ports Menu Icons .....	130
FIGURE 62.	Configuration   Ports   OMNEO Channels .....	130
FIGURE 63.	Configuration   Ports   RVON Channels .....	131
FIGURE 64.	Configuration   Ports   2-Wire Ports .....	132
FIGURE 65.	Configuration   Peripherals Menu Icons .....	133
FIGURE 66.	Configuration   Peripherals   Trunk Master .....	133
FIGURE 67.	Configuration   Peripherals   GPIO-16 .....	134
FIGURE 68.	Configuration   Authentication Menu .....	135
FIGURE 69.	Configuration   Authentication   AZedit .....	135
FIGURE 70.	Configuration   Authentication   IPedit .....	136
FIGURE 71.	Configuration   Authentication   Front Panel .....	137
FIGURE 72.	Configuration   Authentication   Management Port .....	138
FIGURE 73.	Configuration   Authentication   Debug Shell .....	138
FIGURE 74.	Configuration   User Interface Menu .....	139
FIGURE 75.	Configuration   User Interface   LCD Brightness .....	139
FIGURE 76.	Configuration   User Interface   Screen Saver .....	139
FIGURE 77.	Configuration   User Interface   Alpha Size .....	140
FIGURE 78.	Configuration   User Interface   Keypad .....	141
FIGURE 79.	Configuration   User Interface   Options .....	142
FIGURE 80.	Configuration   Advanced Menu Icons .....	143
FIGURE 81.	Configuration   Advanced   DHCP Server .....	143
FIGURE 82.	Configuration   Advanced   SNMP .....	144
FIGURE 83.	Configuration   Advanced   Clock Select .....	146
FIGURE 84.	Intercom Setup   Resources Menu Icons .....	147
FIGURE 85.	Intercom Setup   Stored Setups Menu Icons .....	147
FIGURE 86.	Intercom Setup   Stored Setups   Slot 1 .....	148
FIGURE 87.	Intercom Setup   Keypanels Menu Items .....	151
FIGURE 88.	Intercom Setup   Keypanels   Key Assignments .....	151
FIGURE 89.	Intercom Setup   Keypanels   Setup Pages .....	152
FIGURE 90.	Intercom Setup   Keypanels   Scroll Enables .....	153
FIGURE 91.	Intercom Setup   Resources Menu Icons .....	153

---

FIGURE 92.	Intercom Setup   Resources   Party Line .....	153
FIGURE 93.	Intercom Setup   Resources   IFB .....	154
FIGURE 94.	Intercom Setup   Resources   Special List .....	155
FIGURE 95.	Intercom Setup   Resources   Relay .....	156
FIGURE 96.	Intercom Setup   Resources   ISO .....	157
FIGURE 97.	Intercom Setup   Gains Menu Icons .....	158
FIGURE 98.	Intercom Setup   Gains   I/O .....	158
FIGURE 99.	Intercom Setup   Gains   Crosspoint .....	159
FIGURE 100.	Intercom Setup   Gains   Party Line .....	159
FIGURE 101.	Intercom Setup   Alphas Menu Icons .....	160
FIGURE 102.	Intercom Setup   Alphas .....	160
FIGURE 103.	Alarms Menu Icons .....	162
FIGURE 104.	Alarm Popup Message .....	162
FIGURE 105.	Alarms   Unacknowledged .....	162
FIGURE 106.	Alarms Next Page Button .....	162
FIGURE 107.	Alarms   Active with Clearable and Non-Clearable Alarms .....	163



The ODIN Digital Intercom is a highly scalable intercom system in a 1RU (Rack Unit) package. As the capacity needs evolve, a single ODIN can grow from 16 ports to a maximum of 128 ports. Up to eight ODIN frames can be interconnected via optical Inter-Frame Links creating a single intercom with up to 1024 ports. The total number of licensed ports may be allocated freely to any available port hardware type supported by the frame.

The front panel has been designed to incorporate a User Interface as an alternative option to AZedit that supports the most common setup and configuration tasks. An ODIN intercom system can be controlled and monitored with AZedit and IPedit as well.

Featuring connectors for AIO, OMNEO, RVON and two-wire technology, ODIN supports keypanel technology going forward and, as always, legacy RTS keypanels. OMNEO network connections use standard RJ-45 connectors, and can also use optional Optical Fiber SFP connectors.

---

## *Features*

- A robust digital matrix in a compact 1RU space.
- Built-in OMNEO technology.
- Redundant power supplies.
- Front panel user interface gives easy access to the most common configuration tasks to allow quick modifications to the system.
- Channel expansion through optional licensing and system expansion through trunking supported.
- Energy-efficient design, uses less than 50W of power.

## Reference View – ODIN Front Panel

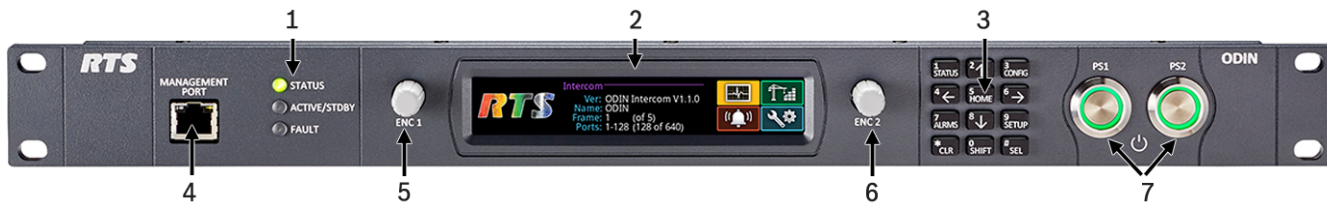
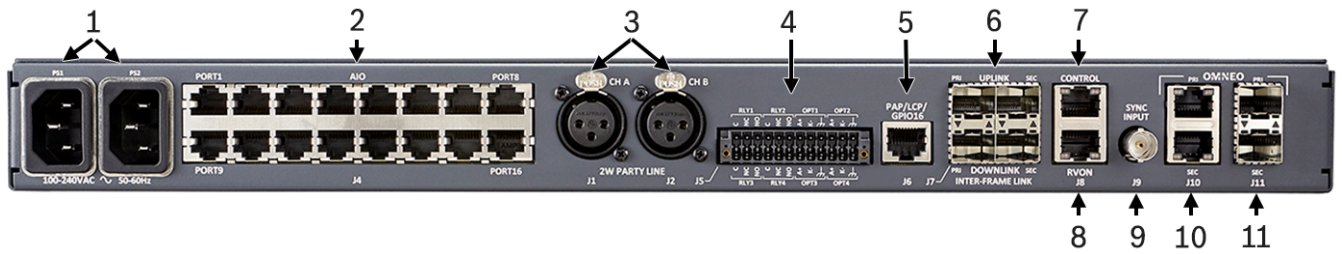

FIGURE 1. ODIN Front Panel

1. Status, Active/Stdby, and Fault LEDs
2. High resolution LCD display
3. Keypad
4. Management port - Ethernet connector (See “Management Port - RJ-45 Supports 10/100/1000 Ethernet” on page 14)
5. ENC 1 - Left encoder knob
6. ENC 2 - Right encoder knob
7. PS1 switch (Power Supply)  
PS2 switch (Power Supply)

## Reference View – ODIN Rear Panel



**FIGURE 2.** ODIN Rear Panel

1. PS 1 – AC power connector  
PS 2 – AC power connector
2. AIO analog connectors – 16x (See “AIO Connector (RJ-45): J4 - x16” on page 14)
3. 2W party line CH A and CH B – 3-pin XLR female connector
4. GPIO connector – 24-position Terminal Block (See “GPIO Connector: J5” on page 15)
5. PAP/LCP/GPIO16 connector – RJ-45 Connector (See “PAP/LCP/GPIO16: J6” on page 15)<sup>a</sup>
6. Inter-frame link connectors
7. Control port – Ethernet connector (See “CONTROL & RVON: J8 Ethernet x 2” on page 15)
8. RVON port
9. Sync Input Connector – BNC connector
10. OMNEO port – Ethernet connectors (See “OMNEO ETHERNET: J10 RJ-45 x 2 Supports 10/100/1000 Ethernet” on page 15)
11. OMNEO port – Optical (fiber) connectors

a. Only used for PAP-32 devices, not PAP-5032 devices.

## Specifications

### Power Supply:

Type ..... Locking IEC 320 C14 style connector  
(2 connectors, fully redundant  
load-sharing power supplies)  
AC Input ..... 100 VAC – 240 VAC,  
60/50 Hz, 0.5 A / 0.35 A

Maximum  
Power Consumption ..... 47 W (based on 120 VAC)

**NOTE:** Lighted power buttons on front panel control DC voltage feed to internal circuitry; they do not disconnect AC from the internal power supplies. Power cords must be fully removed from frame to safely disengage internal power.

### Environmental:

Operating Temperature ..... 32° F – 113° F (0° C – 45° C)  
Storage Temperature ..... -4° F – 158° F (-20° C – 70° C)  
Dimensions:  
19" w/ rack ears (17.3" w/o rack ears) W x 1.7" H x 14.3" D  
(including connectors)  
(482.6 mm w/ rack ears [439 mm w/o rack ears] W x 43.7 mm H  
x 363.5 mm D [including connectors])

### Weight:

ODIN Frame ..... 11.5 lbs (5.2 kg)  
Optional Mounting Bracket ..... 0.86 lbs (390 grams)

### AIO 4-Wire Analog:

Connectors ..... 16 RJ-45 connectors  
Signal Format ..... Differential RX/TX audio with  
differential RS-485 control data

Wiring Scheme ..... Both 568B & USOC supported  
A/D and D/A Resolution ..... 24 bits

Max Input  
Level (balanced) ..... +20 dBu w/o clipping

Digital  
Input Gain ..... Programmable (-20 dB to +20 dB)

Input  
Frequency Response ..... +1 dB/-3 dB from 100 Hz to +20 kHz

THD+N  
(8dBu input, unity gain) ..... 0.025% non-weighted@1 kHz  
<0.075% non-weighted,  
100 Hz to +20 kHz

Nominal Input Impedance ..... >22 kΩ

Nominal Output Level ..... 8 dBu

Digital Output  
Gain ..... Programmable (-20 dB to +20 dB)

Maximum Output  
Level (balanced) @ 600 Ohms ..... 20 dBu w/o clipping

Output  
Frequency Response ..... +1 dB / -3 dB from 100 Hz to +20 kHz

Output Noise Floor ..... <-70 dBu

Crosstalk Isolation ..... >80 dB

### 2-Wire Party Line Analog:

Connector ..... two 3-pin female XLR connectors  
Modes/Port supported ..... RTS CH1, RTS CH2

Audiocom (1 channel)  
Clear-Com (1 channel)

4W/2W Echo Return Loss ..... >45 dB

### Unbalanced Operation (RTS/Clear-Com)

Expected Termination Impedance ..... 200 Ω

Noise Contribution ..... <-70 dBu

THD+N (w/ nominal input) ..... <0.5%, 200 Hz to 7.3 kHz

Bridging Impedance ..... >10 kΩ

CALL Signaling ..... 20 kHz (RTS mode)  
12 VDC (Clear-Com mode)

MIC KILL Signaling ..... 24 kHz (RTS mode)

### Balanced Operation (Audiocom)

Expected Termination Impedance ..... 300 Ω

Noise Contribution ..... <-70 dBu

THD+N  
(with nominal input) ..... <0.5%, 200 Hz to 7.3 kHz

Bridging Impedance ..... >10 kΩ

CALL Signaling ..... 20 kHz (Audiocom mode)

MIC KILL Signaling ..... 24 kHz (Audiocom mode)

### General Purpose Input/Output Ports:

#### Relays

Type ..... SPDT  
Contacts ..... Common (C)

Normally Closed (NC)  
Normally Open (NO)

Contact Rating ..... 1A @ 48 VDC

#### Inputs

Type ..... Optically Coupled

Input Voltage ..... 5 VDC to 12 VDC on A+

**NOTE:** A+ is internally pulled to +5 VDC. Connect K-to chassis ground to activate.

### <sup>1</sup>PAP/LCP/GPIO Port:

Connector ..... RJ-45

Format ..... RS-485 control data only (no audio)

### Inter-Frame Link Port (2 UPLINK/2 DOWNLINK):

**NOTE:** Supports expansion and connection of up to eight ODIN frames.

Fiber Connector Type ..... Small Form Factor  
Pluggable (SFP)

Multimode ..... Finisar FTLF8519P3BNL  
500 m / 2.125 Gbps

Single Mode ..... Finisar FTLF1421P1BTL  
15 km / 2.67 Gbps

Speed ..... 2 Gbps

LED Indicator ..... Optical Signal Present

**NOTE:** SFF-8472 fiber diagnostics supported

1. Only used for PAP-32 devices, not PAP-5032 devices.



**Control Port:**

Connector ..... RJ-45  
 Format ..... IEEE 802.3 compliant  
 Speed ..... 10/100/1000 Mbps  
 LEDs ..... Speed and Link/Activity

**Sync Input Port:**

Connector ..... BNC  
 Termination Impedance ..... 75 Ω  
 Input Frequency Range ..... 48 kHz ±25 ppm  
 Input Level ..... 5V TTL Compatible

**OMNEO Port (primary and secondary):**

Maximum Capacity ..... 128 Full-duplex ports  
 Copper Connector Type ..... RJ-45  
 Format ..... IEEE 802.3 compliant  
 Copper Ethernet Speed ..... 100/1000 Mbps  
 LEDs ..... Speed and Link/Activity  
 Fiber Connector Type ..... Small Form Factor Pluggable (SFP)  
 Multimode ..... Finisar FTLF8519P3BNL  
 500 m / 2.125 Gbps  
 Single Mode ..... Finisar FTLF1421P1BTL  
 15 km / 2.67 Gbps  
 Fiber Speed ..... 100/1000 Mbps  
 LEDs ..... Speed and Link/Activity  
 LED Indicator ..... Optical Signal Present

**NOTE:** SFF-8472 fiber diagnostics supported

**RVON Port**

Compression	Bit Rate	Coding Delay	Playout Delay	Bandwidth	Sample Rate
G.711	64 kbps	125 μs	20-60 ms	160-224 kbps	8 k
G.729AB	8 kbps	10 μs	20-120 ms	32-112 kbps	8 k
G.722	64 kbps	4 μs	20-60 ms	160-224 kbps	16 k

\* Data rate depends on codec selection.  
**NOTE:** The playout delay and bandwidth depend on the configured amount of audio per packet.

**TFT Display:**

Active Area ..... 120.10 mm (wide) x 18.77 mm (high)  
 Dot Resolution ..... 576 x 90 pixels  
 Color Resolution ..... 16-bit (64 K) RGB color  
 View Angle ..... 80° (typical, all directions)  
 Protective Lens ..... Anti-Glare / Anti-Reflective

**Front Panel Management Port:**

Connector ..... RJ-45  
 Format ..... IEEE 802.3 compliant  
 Speed ..... 10/100/1000 Mbps  
 LEDs ..... Speed & Link/Activity

**Agency Compliance:**

**Emissions (Class A)**

- EN 55032:2012/AC:2013
- KN32 w RRA Public Notification 2016-26 & RRA Announce 2016-79
- AS/NZS CISPR 32:2015
- VCCI-CISPR 32:2016
- ICES-003, Issue 6:2016, Updated April 2017
- FCC Part 15 Subpart B
- Chinese National Standard 13438 (2008)

**Immunity**

- EN55024:2010
- KN32 w RRA Public Notification 2016-26 & RRA Announce 2016-79

**Safety**

- UL 60950-1 and CAN/CSA C22.2 No.60950-1-07
- UL 62368-1
- Japanese PSE compliance

## Connections

### RJ-45 Ethernet Connectors

Use the Ethernet connector to connect ODIN to a network. Each RJ-45 Ethernet connector has two LEDs:

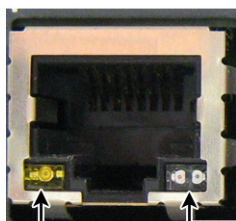

Left LED (yellow)      Right LED (bi-color orange/green)

**Left LED.** The left LED is yellow and indicates a network link is established. It flashes on/off whenever there is network activity.

**Right LED.** The right LED is bi-color (orange and green) and indicates the speed of the connection by the color displayed.

- A green LED indicates the port is operating at 1000Mbps (1 Gbps). This is suitable for OMNEO networking.
- An orange LED indicates the port is operating at 100Mbps.
- No LED color indicates the port is operating at 10Mbps. This is not suitable for OMNEO nor RVON networking.

## Connector Pinouts

### Front Panel Connector

Management Port - RJ-45 Supports 10/100/1000 Ethernet	
Pin	Assignment
1	Data 1 +
2	Data 1 -
3	Data 2 +
4	Data 3 +
5	Data 3 -
6	Data 2-
7	Data 4+
8	Data 4-





### Rear Panel Connectors

2W Party Line: J1 & J2 <sup>a</sup>			
Pin	RTS	Audiocom	Clear-Com
1	GND	GND	GND
2	RTS CH1 (+30 V)	Audio Hi (+24 V)	(+30 V)
3	RTS CH2 (Optional +30 V)	Audio Low (+24 V)	Audio

a. ODIN does not supply power.

AIO Connector (RJ-45): J4 - x16	
Pin	Assignment
1	Data +
2	Data -
3	Audio Out +
4	Audio In +
5	Audio In -
6	Audio Out -
7	Data +
8	Data -

AIO Connector (RJ-12): J4 - x16	
Pin	Assignment
1	Data -
2	Audio Out +
3	Audio In +
2	Audio In -
3	Audio Out -
6	Data +

GPIO Connector: J5		
Pin	Assignment	Silk Screen
1	RELAY1_COM	C
2	RELAY1_NC	NC
3	RELAY1_NO	NO
4	RELAY2_COM	C
5	RELAY2_NC	NC
6	RELAY2_NO	NO
7	OPTO1_ANODE	A+
8	OPTO1_CATHODE	K-
9	Chassis GND	
10	OPTO2_ANODE	A+
11	OPTO2_CATHODE	K-
12	Chassis GND	
13	RELAY3_COM	C
14	RELAY3_NC	NC
15	RELAY3_NO	NO
16	RELAY4_COM	C
17	RELAY4_NC	NC
18	RELAY4_NO	NO
19	OPTO3_ANODE	A+
20	OPTO3_CATHODE	K-
21	Chassis GND	
22	OPTO4_ANODE	A+
23	OPTO4_CATHODE	K-
24	Chassis GND	

CONTROL & RVON: J8 Ethernet x 2	
Pin	Assignment
1	Data 1 +
2	Data 1 -
3	Data 2 +
4	Data 3 +
5	Data 3 -
6	Data 2-
7	Data 4+
8	Data 4-

OMNEO ETHERNET: J10 RJ-45 x 2 Supports 10/100/1000 Ethernet	
Pin	Assignment
1	Data 1 +
2	Data 1 -
3	Data 2 +
4	Data 3 +
5	Data 3 -
6	Data 2-
7	Data 4+
8	Data 4-

<sup>a</sup> PAP/LCP/GPIO16: J6	
Pin	Assignment
1	RS-485 +
2	RS-485 -
3	N/C
4	N/C
5	N/C
6	N/C
7	RS-485 +
8	RS-485 -

a. Only used for PAP-32 devices, not PAP-5032 devices.

---

## Licensing

ODIN comes in 16-port, 32-port, 64-port, and 128-port versions, with an option to upgrade in 16-port increments on all versions (except the 128-port version).

For more information, see “Download a Splash Screen, Screen Saver or Licenses” on page 77.

---

## ODIN System Descriptions

---

### Single-Frame System

ODIN can connect to keypanels via OMNEO, RVON, and AIO. Up to 16 analog panels can be directly connected via the AIO ports on the back of each ODIN frame..

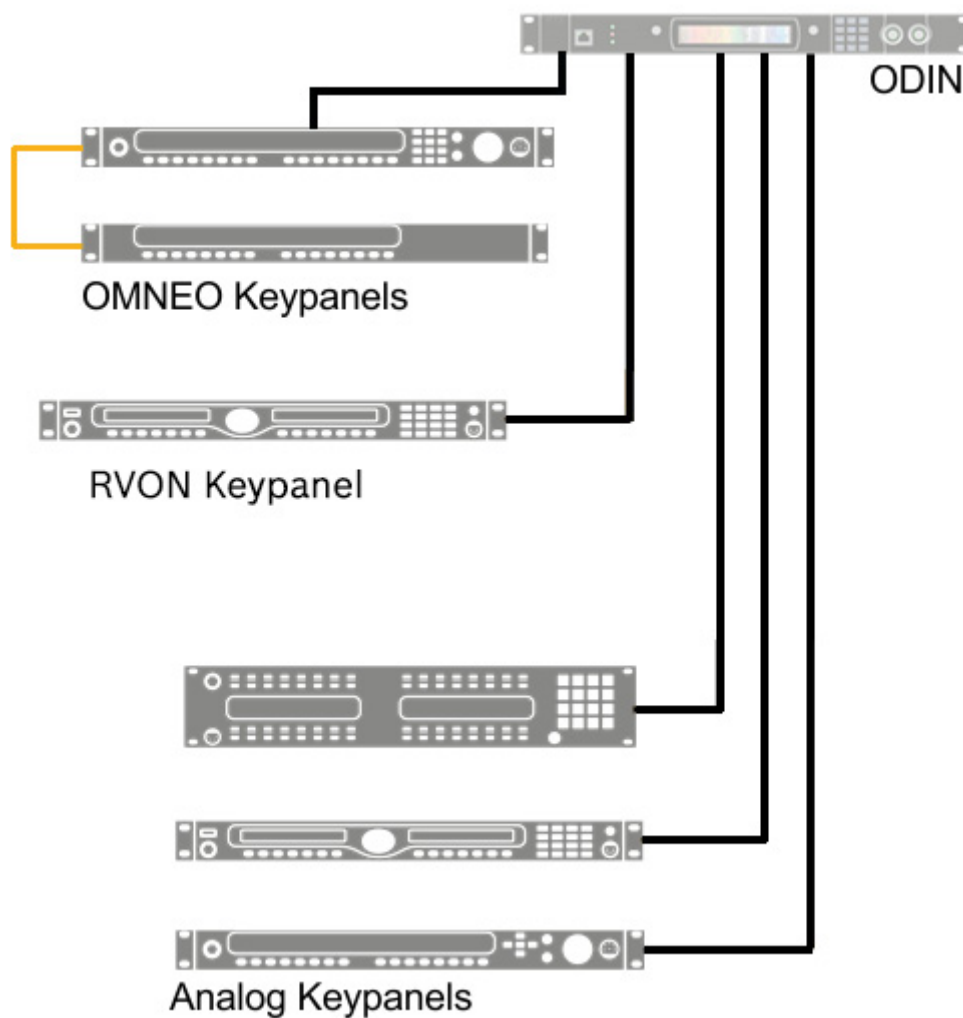

FIGURE 3. Single-Frame System

### Multi-Frame System

For more information, see “IFL Inter-Frame Linking (Multi-Frame Only)” on page 41.

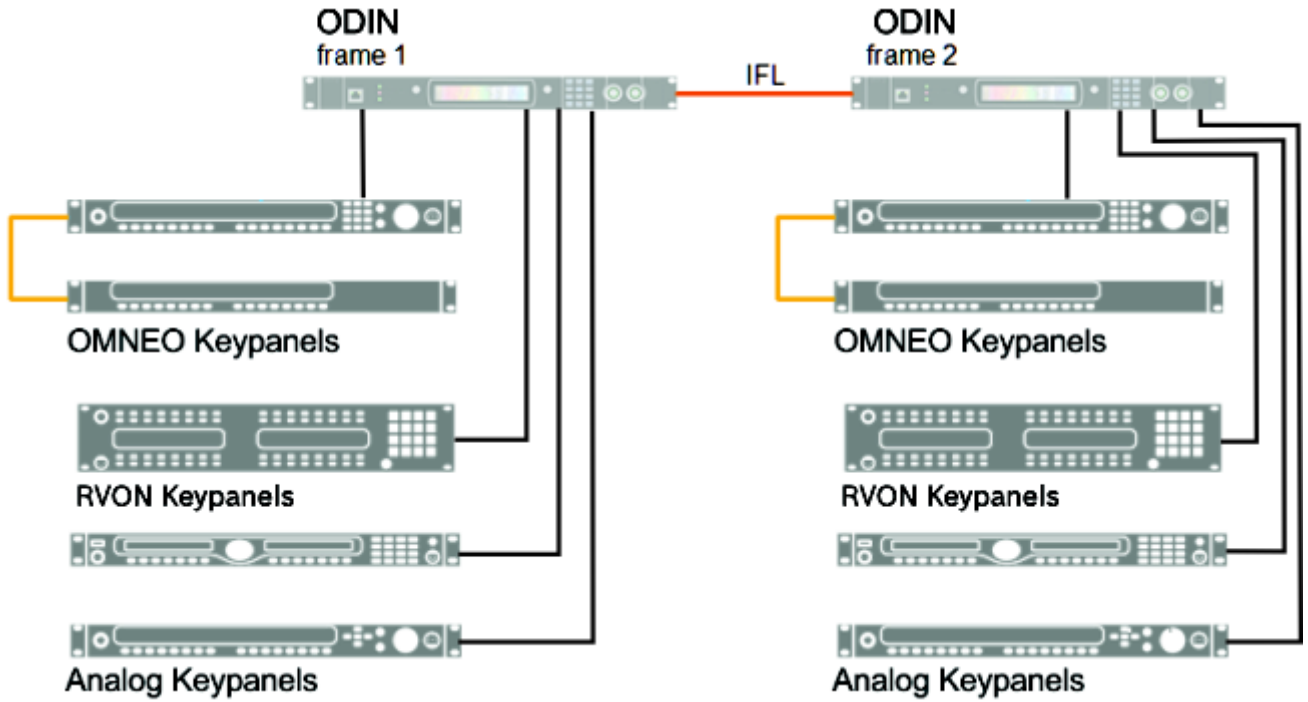

FIGURE 4. Multi-Frame System



## Basic Operation

### Navigating the Menu

The ODIN menu structure is separated into four logical sections: *Status*, *Configuration*, *Intercom Setup*, and *Alarms*. The menu is accessible using the keypad, the shaft encoder knobs, or a combination of both.



FIGURE 5. ODIN Keypad and Encoders

### Keypad Operation

Keypad Character/ Mode	Home	Port Status Overview	Menu	Form (navigating)	Form (navigating) + SHIFT)
1/STATUS	Go to STATUS menu	Go to STATUS menu	Go to STATUS menu		
2/UP	Scroll info up	Scroll info up	Move to previous sibling in menu	Move to previous field (up)	
3/CONFIG	Go to CONFIG menu	Go to CONFIG menu	Go to CONFIG menu		
4/LEFT	Rotate icon highlight CCW		Move icon highlight left	Move to prev field (left)	
5/HOME	Go to Port Status Overview	Go to HOME screen	Go to HOME screen	Go to field (top/left)	
6/RIGHT	Rotate icon highlight CW		Move icon highlight right	Move to next field (right)	
7/ALARMS	Go to ALARM menu	Go to ALARM menu	Go to ALARM menu		
8/DOWN	Scroll info down	Scroll info down	Move to the next sibling menu	Move to next field (down)	
9/SETUP	Go to SETUP menu	Go to SETUP menu	Go to SETUP menu		
0/SHIFT	Toggle SHIFT state	Toggle SHIFT state	Toggle SHIFT state	Toggle SHIFT state	
*/CLR	Move to info top	Go to HOME	Move up one menu level	Exit form (prompt if changes)	Exit form (abort changes)
#/SEL	Invoke highlighted icon		Invoke highlighted icon	Initiate edit on selected field	Exit form (save changes)

## Shaft Encoder Operation

	Action/Mode	Home	Port Status Overview	Menu	Form (navigating)	Form (navigating) + SHIFT)
<b>Left Encoder</b>	<i>Click</i>	Go to STATUS overview	Go to HOME screen	Move up one level	Exit form (prompt if changes)	
	<i>Double Click</i>	Move to info top	Move to info top	Go to HOME screen	Exit form (abort changes)	
	<i>Press + Hold</i>	Activate screensaver / Logout	Activate screensaver / Logout	Activate screensaver / Logout	Activate screensaver / Logout	
	<i>Rotate</i>	Scroll info up / down	Scroll info up / down	Move to next / prev sibling	Scroll form up / down	
<b>Right Encoder</b>	<i>Click</i>	Invoke highlighted icon		Invoke highlighted icon	Initiate edit on selected field	
	<i>Double Click</i>	Move to info top	Go to HOME screen	Move up one menu level	Exit form (save changes)	
	<i>Rotate</i>	Rotate icon highlight		Move icon highlight left / right	Move to next / prev field	

## Editing Form Data

Throughout the front panel menu system are configuration forms. Forms can be viewed and modified using either the keypad, the encoder knobs or a combination of both.

## Keypad Operation

Keypad Character/ Mode	Form (editing): Text	Form (editing) + SHIFT: Text	Form (editing): Spinner	Form (editing): Pick List	Form: Check box
<i>1/STATUS</i>					
<i>2/UP</i>	Change character at cursor	Insert new character at cursor	Increment value	Select next entry	Move to prev field (up)
<i>3/CONFIG</i>					
<i>4/LEFT</i>	Change cursor location	Go to first character			Move to prev field (left)
<i>5/HOME</i>	Toggle letter case	Toggle between start of digits, start of lowercase letters, and start of uppercase letters	Select minimum value	Select first entry	Go to first field (top/left)
<i>6/RIGHT</i>	Change cursor location	Go to end of text			Move to next field (right)
<i>7/ALARMS</i>					
<i>8/DOWN</i>	Change character at cursor	Delete character	Decrement value	Select previous entry	Move to next field (down)
<i>9/SETUP</i>					
<i>0/SHIFT</i>	Toggle SHIFT state	Toggle SHIFT state	Toggle SHIFT state	Toggle SHIFT state	Toggle SHIFT state
<i>*/CLR</i>	Backspace (delete previous character and move backward)	Abort any changes	Abort changes	Abort changes	Exit form (prompt if changes)
<i>#/SEL</i>	Accept character at current location and move to the next character	Save changes	Save changes	Save changes	Toggle check state



**NOTE:**

- Pressing CLR does a backspace if the cursor is not at the start of a field. At the start of a field, CLR deletes the character at the cursor.
- Press CLR when there is no text in the field aborts the changes.
- Pressing UP/DOWN from the end of a text (when the cursor is shown as an underline) starts the character offerings at the spot of previous character (to the left). If the previous character was an “m”, pressing UP/DOWN would display an “n”.

**Shaft Encoder Operation**

	<b>Keypad Character/Mode</b>	<b>Form (editing): Text</b>	<b>Form (editing) + SHIFT: Text</b>	<b>Form (editing): Spinner</b>	<b>Form (editing): Pick List</b>	<b>Form: Check box</b>
<b>Left Encoder</b>	<i>Click</i>	Delete character	Edit cancel (abort changes)	Edit cancel (abort changes)	Edit cancel (abort changes)	Exit form (prompt if changes)
	<i>Double Click</i>	Edit cancel (abort changes)	Edit cancel (abort changes)	Edit cancel (abort changes)	Edit cancel (abort changes)	Exit form (abort changes)
	<i>Press + Hold</i>	Activate screensaver / Logout	Activate screensaver / Logout	Activate screensaver / Logout	Activate screensaver / Logout	Activate screensaver / Logout
	<i>Rotate</i>	Move character highlight	Move character highlight	Scroll form up / down	Scroll form up / down	Scroll form up / down
<b>Right Encoder</b>	<i>Click</i>	Move to next character	Edit done (save changes)	Edit done (save changes)	Edit done (save changes)	Toggle check state
	<i>Double Click</i>	Edit done (save changes)	Edit done (save changes)	Edit done (save changes)	Edit done (save changes)	Exit form (save changes)
	<i>Rotate</i>	Change current character	Toggle letter case (current char)	Change value	Change selected entry	Move to next / previous

## ODIN Icon and Menu Descriptions

### Display Panel Icons

**Display Panel Icons** are used to navigate the menu structure on the ODIN frame. Use Table 1 for a complete description of each icon seen in the menu and submenu structure.

**TABLE 1.** Display Icon Description and Menu Structure





Icon	Icon Name	Description
	<b>Status</b>	The <b>Status</b> menu is used to view status information for the intercom.  For more information, see “Status Menu” on page 82.
	<b>System</b>	The <b>System</b> menu item is used to select the system status to be viewed.  For more information, see “System Menu” on page 82.
	ODIN Versions	The <b>ODIN Versions</b> menu item displays the version number for each ODIN component (firmware or FPGA) currently installed on the frame.  For more information, see “ODIN Versions” on page 82.
	AZedit Sessions	The <b>AZedit Sessions</b> menu displays the name (if available) and associated IP Address of each user connected to the frame via AZedit.  For more information, see “AZedit Sessions” on page 83.
	IPedit Sessions	The <b>IPedit Sessions</b> menu displays the name and associated IP Address of each user connected to the frame via IPedit.
	<b>Network</b>	The <b>Network</b> menu item is used to select the network connection status to be viewed.  For more information, see “Network Menu” on page 84.
	Control Port	The <b>Control Port</b> menu item displays status details for the Control Port.  For more information, see “Control Port” on page 84.
	OMNEO (SFP)	The <b>OMNEO (SFP)</b> menu item displays status details for the OMNEO SFP fiber ports.  For more information, see “OMNEO (SFP)” on page 85.

TABLE 1. Display Icon Description and Menu Structure



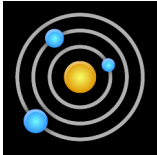

Icon	Icon Name	Description
	OMNEO (RJ-45)	The <b>OMNEO (RJ-45)</b> menu item displays status details for the OMNEO RJ-45 ports.  For more information, see “OMNEO (RJ-45)” on page 87.
	RVON	The <b>RVON</b> menu item displays status details for the RVON RJ-45 port.  For more information, see “RVON” on page 88.
	Management Port	The <b>Management Port</b> menu item displays status details for the MANAGEMENT PORT (Local Management Port).  For more information, see “Management Port” on page 89.
	<b>Ports</b>	The <b>Ports</b> menu item is used to select the port type status to be viewed.  For more information, see “Ports” on page 90.
	OMNEO	The <b>OMNEO</b> menu item displays status details for OMNEO ports.  For more information, see “OMNEO” on page 90.
	RVON	The <b>RVON</b> menu item displays status details for RVON ports.  For more information, see “RVON” on page 91.
	AIO	The <b>AIO</b> menu item displays status details for AIO ports.  For more information, see “AIO” on page 93.
	2-Wire	The <b>2-Wire</b> menu item displays status details for 2-Wire ports.  For more information, see “2-Wire” on page 94.
	Keypanel	The <b>Keypanel</b> menu item displays status details for connected keypanels.  For more information, see “Keypanel” on page 95.
	TIF	The <b>TIF</b> menu item displays status details for connected TIFs.  For more information, see “TIF” on page 96.

TABLE 1. Display Icon Description and Menu Structure



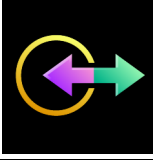



Icon	Icon Name	Description
	<b>Peripherals</b>	The <b>Peripherals</b> menu item is used to select the peripheral status to be viewed.  For more information, see “Peripherals Menu” on page 97.
	Trunk Masters	The <b>Trunk Masters</b> menu item displays status details for the Trunk Master(s) connected to the intercom system.  For more information, see “Trunk Master” on page 97.
	GPIO-16	The <b>GPIO</b> menu item displays status details for any GPIO-16 connected to the intercom system.  For more information, see “GPIO-16” on page 99.
	LCP-102	The <b>LCP</b> menu item displays the status details for any LCP-102 connected to the intercom system.  For more information, see “LCP-102” on page 100.
	PAP-32	The <b>PAP-32</b> menu item displays the status details for any PAP-32 connected to the intercom system.  For more information, see “PAP-32” on page 101.
	PAP-5032	The <b>PAP-5032</b> menu item displays the status details for any PAP-5032 connected to the intercom system.  For more information, see “PAP-5032” on page 102.
	<b>Intercom</b>	The <b>Intercom</b> menu item is used to select the type of intercom status to be viewed.  For more information, see “Intercom Menu” on page 103.
	GPIO	The <b>GPIO</b> menu item displays GPIO input and output states.  For more information, see “GPIO” on page 103.
	Crosspoint Inspect	The <b>Crosspoint Inspect</b> menu item displays status the crosspoint status for the selected input and output ports.  For more information, see “Crosspoint Inspect” on page 104.
	Frame to Frame	The <b>Frame to Frame</b> menu item displays the status of the logical connections (via Ethernet) between each frame.  For more information, see “Frame to Frame (Multi-frame Only)” on page 105.

TABLE 1. Display Icon Description and Menu Structure



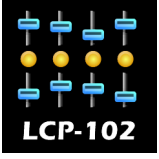

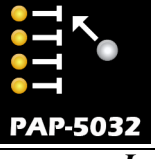

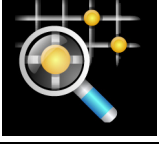
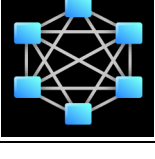

Icon	Icon Name	Description
	IFL	The <b>IFL</b> menu item displays status details for IFL connections.  For more information, see “IFL” on page 107.
	<b>Hardware</b>	The <b>Hardware</b> menu item is used to select the hardware status to be viewed.  For more information, see “Hardware Menu” on page 110.
	Power Supplies	The <b>Power Supplies</b> menu item displays status information on the power supplies in each frame.  For more information, see “Power Supplies” on page 110.
	Cooling Fans	The <b>Cooling Fans</b> menu item displays status information for the cooling fans in each frame.  For more information, see “Cooling Fans” on page 111.
	Temperatures	The <b>Temperatures</b> menu item displays status information for the temperature sensors in each frame.  For more information, see “Temperatures” on page 112.
	Clock	The <b>Clock</b> menu item displays the status of the system clock (PTP) for each frame.  For more information, see “Clock” on page 113.
	<b>Configuration</b>	The <b>Configuration</b> menu is used for the initial configuration or re-configuration of fundamental intercom settings (such as intercom size, network configuration, peripheral configuration, authentication, and user preferences).  For more information, see “Configuration Menu” on page 114.
	<b>System</b>	The <b>System</b> menu is used to set or change the intercom size, frame mapping, or port allocation. The intercom name may also be set from this menu if the intercom is not connected to a Trunk Master.  For more information, see “System Menu” on page 114.
	Intercom Size	The <b>Intercom Size</b> menu is used to select the action to be taken to modify the intercom size.  For more information, see “Intercom Size” on page 115.
	Reconfigure	The <b>Reconfigure</b> menu item is used to resize the intercom in a manner similar to that seen in AZedit.  For more information, see “Reconfigure” on page 116.

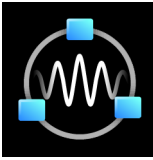
TABLE 1. Display Icon Description and Menu Structure





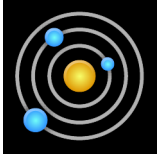



Icon	Icon Name	Description
	Add Frames	<p>The <b>Add Frames</b> menu is used to add a new frame to an existing intercom by connecting a new frame via IFL. The Frame Mapping Table is updated automatically and a new system size is automatically determined (but may be modified by the user before being applied).</p> <p>For more information, see “Add Frames” on page 120.</p>
	Remove Frames	<p>The <b>Remove Frames</b> menu item is used to remove all the frames following the current frame from the intercom. The Frame Mapping Table and Intercom Size are automatically updated.</p> <p>This icon only appears when a multiframe system is running.</p> <p>For more information, see “Remove Frames” on page 122.</p>
	Split Frames	<p>The <b>Split Intercom</b> menu item is used to break larger intercom systems into smaller systems. Whereas the Remove Frame menu is used to remove individual frames from an intercom system, the Split Frame menu is used to remove a block of frames from one system to create two smaller intercom systems with multiple frames in each.</p> <p><b>NOTE:</b> This item is only visible if there is more than one frame following the current frame.</p>
	Frame Mapping Table	<p>The <b>Frame Mapping Table</b> menu item is used to identify which frames make up the intercom, and to set the frame number order for each frame.</p> <p>This icon only appears when a multiframe system is running.</p> <p>For more information, see “Frame Mapping Table” on page 124.</p>
	Port Allocation Table	<p>The <b>Port Allocation Table</b> menu item is used set the port type (OMNEO, AIO, 2W, and RVON) for each intercom port (in each frame), as well as to map the physical analog connectors (AIO and 2W) in each frame to ports of those types.</p> <p>For more information, see “Port Allocation Table” on page 125.</p>
	Intercom Name	<p>The <b>Intercom Name</b> menu item is used to rename the intercom system.</p> <p><b>NOTE:</b> The intercom name may only be changed if the intercom is not currently connected to a Trunk Master.</p> <p>For more information, see “Intercom Name” on page 126.</p>
	<b>Network</b>	<p>The <b>Network</b> menu is used to configure the network interfaces for the current frame.</p> <p>For more information, see “Network Menu” on page 127.</p>
	Control Port	<p>The <b>Control Port</b> menu item is used to configure the Ethernet network configuration for the Control Port for the current frame.</p> <p>For more information, see “Control Port” on page 127.</p>
	OMNEO	<p>The <b>OMNEO</b> menu item is used to configure the Ethernet network configuration for the OMNEO Ports for the current frame.</p> <p>For more information, see “OMNEO” on page 128.</p>

TABLE 1. Display Icon Description and Menu Structure

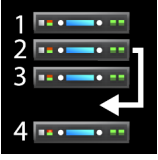







Icon	Icon Name	Description
	RVON	The <b>RVON</b> menu item is used to configure the Ethernet network configuration for the RVON Ports for the current frame.  For more information, see “RVON” on page 129.
	Management Port	The <b>Management Port</b> menu item is used to configure the Ethernet network configuration for the Management Port located on the front panel.  For more information, see “Management Port” on page 129.
	<b>Ports</b>	The <b>Ports</b> menu is used to select the type of ports to be configured.  For more information, see “Ports Menu” on page 130.
	OMNEO Channels	The <b>OMNEO Channels</b> menu item is used to configure the partner devices for the OMNEO channels in each frame.  For more information, see “OMNEO Channels” on page 130.
	RVON Channels	The <b>RVON Channels</b> menu item is used to configure the partner devices for the RVON channels in each frame.  For more information, see “RVON Channels” on page 131.
	2-Wire Ports	The <b>2-Wire Ports</b> menu item is used to configure the operating mode for the 2-wire ports in each frame.  For more information, see “2-Wire Ports” on page 132.
	<b>Peripherals</b>	The <b>Peripherals</b> menu is used to select the peripheral to be configured.  For more information, see “Peripherals Menu” on page 133.
	Trunk Master	The <b>Trunk Master</b> menu item is used to configure the Trunk Master for use in the intercom system.  For more information, see “Trunk Master” on page 133.
	GPIO-16	The <b>GPIO-16</b> menu item is used to configure the GPIO-16 for use in the intercom system.  For more information, see “GPIO-16” on page 134.
	<b>Authentication</b>	The <b>Authentication</b> menu is used to select different areas of the ODIN system to configure security.  For more information, see “Authentication Menu” on page 135.

TABLE 1. Display Icon Description and Menu Structure

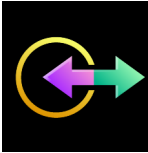

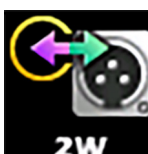



Icon	Icon Name	Description
	AZedit	The <b>AZedit</b> menu item is used to restrict access to AZedit.  For more information, see “AZedit” on page 135.
	IPedit	The <b>IPedit</b> menu item is used to restrict access to IPedit.  For more information, “IPedit” on page 136.
	Front Panel	The <b>Front Panel</b> menu item is used to configure access restrictions for the front panel (including setting PINs for menu access).  For more information, see “Front Panel” on page 137.
	Management Port	The <b>Management Port</b> menu item is used to enable or disable AZedit support on the Management Port.  For more information, see “Management Port” on page 138.
	Debug Shell	The <b>Debug Shell</b> menu item is used to access the Debug Shell Authentication form. This form is used to restrict access to the Debug Shell.  For more information, see “Debug Shell” on page 138.
	<b>User Interface</b>	The <b>User Interface</b> menu is used to view and modify user interface preferences.  For more information, “User Interface Menu” on page 139
	LCD Brightness	The <b>LCD Brightness</b> menu item is used to configure the brightness of the front panel LCD.  For more information, see “LCD Brightness” on page 139.
	Screen Saver	The <b>Screen Saver</b> menu item is used to modify the screen saver settings and how the screen saver is displayed.  For more information, see “Screen Saver” on page 139.
	Alpha Size	The <b>Alpha Size</b> menu item is used to select the alpha size used to display alphas via the front panel user interface.  For more information, see “Alpha Size” on page 140.
	Keypad	The <b>Keypad</b> menu item is used to configure the Keypad settings (including LED colors, and brightness for Keypad mode).  For more information, see “Keypad” on page 141.



TABLE 1. Display Icon Description and Menu Structure





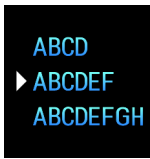
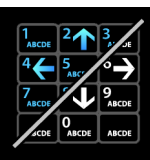



Icon	Icon Name	Description
	Options	<p>The <b>Options</b> menu item is used to access the Options configuration form. This form is used to define how ODIN constructs work on the frame.</p> <p>For more information, see “Options” on page 142.</p>
	<i>Advanced</i>	<p>The <b>Advanced</b> menu is used to select advanced configuration options to modify.</p> <p>For more information, “Advanced Menu” on page 143.</p>
	DHCP Server	<p>The <b>DHCP Server</b> menu item is used to set up or modify the DHCP server settings.</p> <p>For more information, see “DHCP Server” on page 143.</p>
	SNMP	<p>The <b>SNMP</b> menu item is used to set up or modify SNMP settings.</p> <p>For more information, see “SNMP” on page 144.</p>
	Clock Select	<p>The <b>Clock Select</b> menu item is used to synchronize audio across the frames in an intercom system.</p> <p>For more information, see “Clock Select” on page 146.</p>
	Soft Reset	<p>The <b>Soft Reset</b> menu item is used to perform a soft reset on the frame.</p> <p>For more information, see “Soft Reset” on page 146.</p>
	<i>Intercom Setup</i>	<p>The <b>Intercom Setup</b> menu is used to select the various intercom setup options such as Resources, Gains, and Alphas.</p> <p>For more information, see “Intercom Setup Menu” on page 147.</p>
	<i>Stored Setups (Single Frame Only)</i>	<p>The <b>Stored Setups</b> menu is used to select the slot folder to store, modify or delete intercom setup files.</p> <p>This menu item only appears when a single frame system is running.</p> <p>For more information, see “Stored Setups Menu (Single Frame Only)” on page 147.</p>

TABLE 1. Display Icon Description and Menu Structure











Icon	Icon Name	Description
	Stored Setups	The <b>Stored Setup Slot</b> files are used to store, modify, or delete intercom setup files.  Up to four stored setups (Slots) can be configured and saved in ODIN.
		
		
		
	<b>Keypanels</b>	The <b>Keypanels</b> menu is used to select the various keypanel setup options such as Key Assignments, Setup Pages, and Scroll Enables.  For more information, see “Keypanels Menu” on page 151.
	Key Assignments	The <b>Key Assignments</b> menu is used to set up key assignments on keypanel keys.  For more information, see “Key Assignments” on page 151.
	Setup Pages	The <b>Setup Pages</b> menu item is used to setup additional pages on a keypanel port.  For more information, see “Setup Pages” on page 152.
	Scroll Enables	The <b>Scroll Enables</b> menu item is used to set up scroll enables and latch disable.  For more information, see “Scroll Enables” on page 153.
	<b>Resources</b>	The <b>Resources</b> menu item is used to select the assignment type to configure.
	Party Line	The <b>Party Line</b> menu item is used to define party lines in the intercom system.  For more information, see “Party Line” on page 153.

TABLE 1. Display Icon Description and Menu Structure









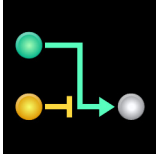
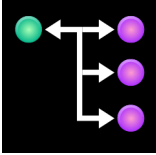
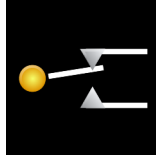
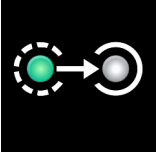

Icon	Icon Name	Description
	IFB	The <b>IFB</b> menu item is used to configure IFBs.  For more information, “IFB” on page 154.
	Special List	The <b>Special List</b> menu item is used to configure special lists.  For more information, “Special List” on page 155.
	Relay	The <b>Relay</b> menu item is used to configure a relays.  For more information, “Relay” on page 156.
	ISO	The <b>ISO</b> menu item is used to configure ISOs.  For more information, “ISO” on page 157.
	<b>Gains</b>	The <b>Gains</b> menu is used to select the type of gain modification to be made.  For more information, see “Gains Menu” on page 158.
	I/Os	The <b>I/Os</b> menu item is used to set I/O Gains for different ports in the intercom system.  For more information, see “I/O” on page 158.
	Crosspoint	The <b>Crosspoint</b> menu item is used to set crosspoint gains in the system.  For more information, see “Crosspoint” on page 159.
	Party Line	The <b>Party Line</b> menu item is used to set Party Line gains in the system.  For more information, see “Party Line” on page 159.
	<b>Alphas</b>	The <b>Alpha</b> menu is used to select the type of alpha assignment.  For more information, see “Alphas Menu” on page 160.
	Port	The <b>Port</b> menu item is used to view and edit the Alpha(s) and Scroll Enable flags for each port assignment.

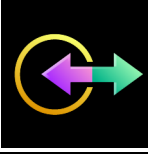
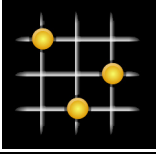
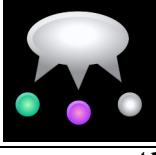
TABLE 1. Display Icon Description and Menu Structure

Icon	Icon Name	Description
	Party Line	The <b>Party Line</b> menu item is used to view and edit the Alpha(s) and Scroll Enable flags for each party line assignment.
	IFB	The <b>IFB</b> menu item is used to view and edit the Alpha(s) and Scroll Enable flags for each IFB assignment.
	Special List	The <b>Special List</b> menu item is used to view and edit the Alpha(s) and Scroll Enable flags for each special list assignment.
	Relay	The <b>Relay</b> menu item is used to view and edit the Alpha(s) and Scroll Enable flags for each relay assignment.
	ISO	The <b>ISO</b> menu item is used to view and edit the Alpha(s) and Scroll Enable flags for each ISO assignment.
	<b>Alarms</b>	The <b>Alarms</b> menu is used to access alarm notifications of events that occur in the intercom system. If the sound waves in the icon are flashing there are unacknowledged alarms in the system.  For more information, see “Alarms Menu” on page 162.
	Unacknowledged	The <b>Unacknowledged</b> menu item displays alarms the user has not yet acknowledged (meaning the alarm may not have been seen yet).
	Active	The <b>Active</b> menu item displays all alarms that have occurred and are still active (for example, the fault has not gone away).

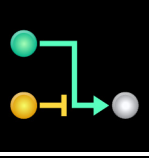
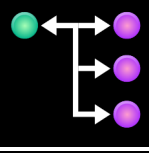
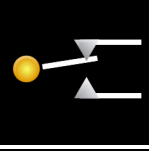
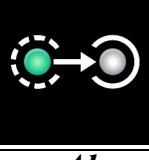
---

## *Front Panel Overview and Operation*

---

---

### *Management Port*

---

The **Management Port** is a front-panel Ethernet interface, providing convenient access for a laptop running AZedit.

Access to the Management Port can be enabled or disabled via the Authentication menu item, see “Management Port” on page 138.

---

### *Front Panel LEDs*

---



**FIGURE 6.** Front Panel LEDs

#### **STATUS LED**

The **STATUS** LED has two colors to indicate overall status of the frame.

- |              |   |
|--------------|---|
| <i>Green</i> | System is working normally  |
| <i>Amber</i> | System is writing to flash (for example, saving the intercom setup to flash, reprogramming the flash after a firmware download) |

#### **ACTIVE / STDBY LED**

The **ACTIVE / STDBY** LED currently uses one color.

- |             |   |
|-------------|---|
| <i>Blue</i> | System is about to reboot (for example, after re-sizing the intercom) |
|-------------|---|

#### **FAULT LED**

The **FAULT** LED is used to indicate faults in the system.

- |              |  |
|--------------|--|
| <i>Off</i>   | All alarms have been acknowledged or cleared                 |
| <i>Red</i>   | One or more critical alarms are unacknowledged               |
| <i>Amber</i> | One or more alarms are unacknowledged, but none are critical |

## Port Status Overview

The **Port Status Overview** displays the port status in each frame of the intercom. The port type and port status are represented by different colored status boxes.

To **display the port status screen**, do the following:

- > While on the Home Screen, click the **left encoder knob**.  
OR  
Press the **Home button** on the keypad.  
*The Port Status screen appears.*

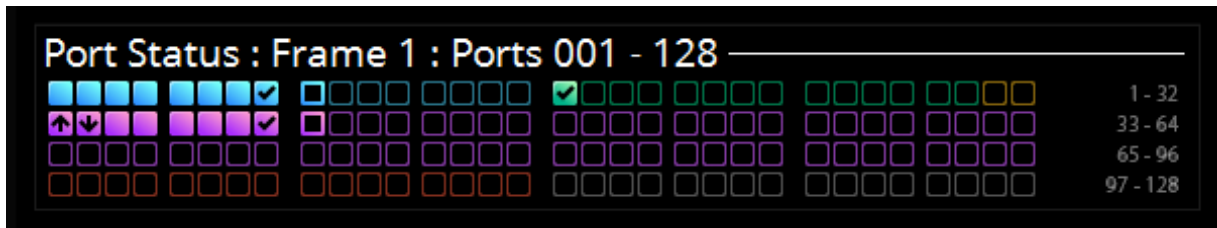

FIGURE 7. Port Status Screen

Color	Description
Blue	RVON
Green	AIO
Gold	2-Wire
Magenta	OMNEO
Red	Port not allocated
Grey	Port not licensed

Icon	Description
	Not Configured (displayed as a square outline in the port type color, see Figure 7)
	Configured, not connected
	Configured, connected, bi-directional audio
	Configured, connected, keypad attached and communicating
	Configured, connected, OMNEO unidirectional receive
	Configured, connected, OMNEO unidirectional transmit
	Port Type has not been defined (red square outline)
	Port is unlicensed (grey square outline)

## Link Status Overview

The **Link Status Overview** screen is used to view the different system connections available on ODIN. The connection status is represented by different colored LEDs.

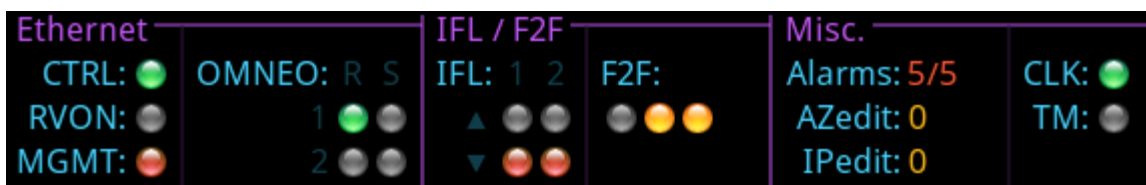

FIGURE 8. Link Status Overview

## Ethernet

The **Ethernet** section displays link status for CTRL, RVON, MGMT, and OMNEO (4) ports.

	GREEN LED	RED LED	GREY LED
<b>CTRL</b> <b>RVON</b> <b>MGMT</b>	The link is up.	The OMNEO (Control or Audio) IP Address is defined, but none of the links are up (for RJ45). For SFP to display red, the above needs to be true and the SFP needs to be installed.	Either no IP Address (Control or Audio) is defined for both RJ45 and SFP, or an IP Address is defined but at least one of the other links is up. For SFP, if no SFP is installed the LED is always grey.
<b>OMNEO</b> The status indicators are displayed to mimic the back panel. The rows labeled 1 and 2 represent PRIMARY and SECONDARY. The columns labeled R and S represent RJ-45 and SFP.			
	The link is up.	The Audio and/or Controller interfaces have an IP Address but none of the four links are up. OR An SFP is installed.	At least one OMNEO link is up. OR No SFP is installed.

**IFL/F2F**

The **IFL/F2F** section displays the IFL link status and the Frame to Frame link status. For single frame configuration, this section is labeled IFL, the F2F label is only displayed in a multi-frame system.

	<b>GREEN LED</b>	<b>YELLOW LED</b>	<b>RED LED</b>	<b>GREY LED</b>
<b>IFL</b>				
The status indicators are displayed to mimic the back panel. The rows labeled with up and down triangles represent uplinks and downlinks. The columns labeled 1 and 2 represent PRIMARY and SECONDARY.				
	The link is up and there is no fault detected.	The link is up but a fault is detected. OR The link is not expected to be up, but an SFP is installed.	The link is down but is expected to be up.	The link is not expected to be up.
<b>NOTE:</b>				
<ul style="list-style-type: none"> <li>IFL downlinks are expected to be up for frames 1 through n-1 (n being the number of frames) of an n frame system. IFL uplinks are expected to be up for frames 2 to n. Uplinks in frame 1 and downlinks in the last frame are not expected, but are acceptable.</li> <li>Because one downlink (or uplink) of the primary/secondary pair is necessary for the system to operate, the red LED is not used for links that are expected to be up (but are not) as long as the redundant link is up and no fault is detected. In this case, the link is shown in grey (unless an SFP is installed, in which case the link is shown in yellow). In other words, if no SFP is installed, the link is not expected to be used and since the redundant link is up, no error/warning is shown. If an SFP is installed, yellow is shown since the link might be expected to be up (for redundancy).</li> </ul>				

	<b>GREEN LED</b>	<b>YELLOW LED</b>	<b>RED LED</b>	<b>GREY LED</b>
<b>F2F</b>				
The status indicators are displayed up to two rows of four LEDs. For systems with less than eight frames, only the number of LEDs corresponding to the number of frames are shown. The top row represents links to frames 1 through 4; the bottom row represents links to frames 5 through 8. For single frame systems, the F2F section is hidden.				
	The link to the corresponding frame is up	The link is not up and no IP address is defined for the frame in the frame mapping table.	The link is not up and the corresponding frame has an IP address defined in the frame mapping table.	The link representing the current frame is always grey. There is never a F2F link to itself.



**Misc.**

The **Misc.** section contains additional status information for Alarms, AZedit sessions, IPedit sessions, PTP clock stats, and TM status.

<b>For Alarms</b>	<p>X/Y is shown, where X is the number of unacknowledged alarms and where Y is the total number of active alarms.</p> <ul style="list-style-type: none"> <li>• when shown in red, X is greater than 0</li> <li>• when shown in yellow, X is equal to 0 and Y is greater than 0</li> <li>• when shown in green, X and Y are equal to 0</li> </ul>
<b>For AZedit</b>	<p>The number of active AZedit sessions.</p> <ul style="list-style-type: none"> <li>• when shown in green, there is at least one AZedit connection</li> <li>• when shown in yellow, there are no AZedit connections</li> </ul>
<b>For IPedit</b>	<p>The number of active IPedit sessions.</p> <ul style="list-style-type: none"> <li>• when shown in green, there is at least one IPedit connection</li> <li>• when shown in yellow, there are no IPedit connections</li> </ul>
<b>For CLK</b>	<p>The status of the PTP clock.</p> <ul style="list-style-type: none"> <li>• when a green LED is displayed, the PTP clock is linked</li> <li>• when a red LED is displayed, the PTP clock is not linked</li> </ul>
<b>For TM</b>	<p>The status of the TM (Trunk Master)</p> <ul style="list-style-type: none"> <li>• when a green LED is displayed, an active link to the TM is detected</li> <li>• when a red LED is displayed, no active link to the TM is detected, but the TM is defined</li> <li>• when a grey LED is displayed, no TM is defined</li> </ul>

## Intercom Port Allocation

The **Port Allocation Table** is used to support and allocate the different types of intercom port assignments across the intercom system. Physical hardware, such as AIO and 2-wire devices, and network port devices, such as RVON and OMNEO, can be mapped to any port in the intercom. For more information, see “Port Allocation Table” on page 125.

For more information on IFL Interconnection Schemes, see the Interconnecting ODIN Frames application guide.

### Allocate Ports from the Front Panel of ODIN

To **allocate ports from the front panel of ODIN**, do the following:

1. Rotating the right encoder knob, navigate to the **Configuration icon**.
2. Click the **right encoder knob**.  
*The Configuration Menu appears.*
3. Rotating the right knob, navigate to the **System menu icon**.
4. Click the **right encoder knob**.  
*The System menu appears.*
5. Rotating the right encoder knob, navigate to the **Port Allocation Table menu icon**.
6. Click the **right encoder knob**.  
*The Port Allocation Table screen appears.*

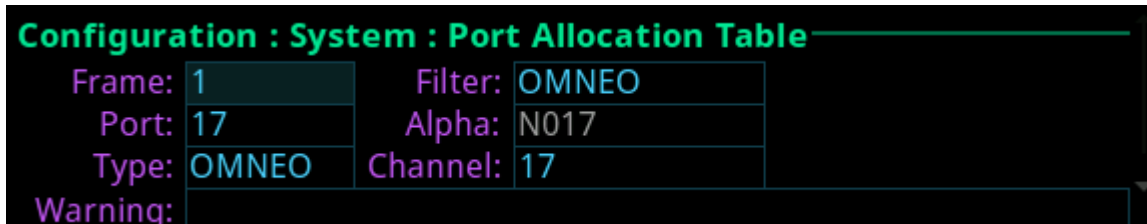

**NOTE:** To move from field to field, rotate the right encoder knob. To scroll the screen up and down, rotate the left encoder knob. To modify a field click the right encoder knob. To exit a screen click the left encoder knob.

7. Rotating the right encoder knob, move the focus to the **Filter field**.
8. Click the **right encoder knob**.  
*The Filter field becomes active.*

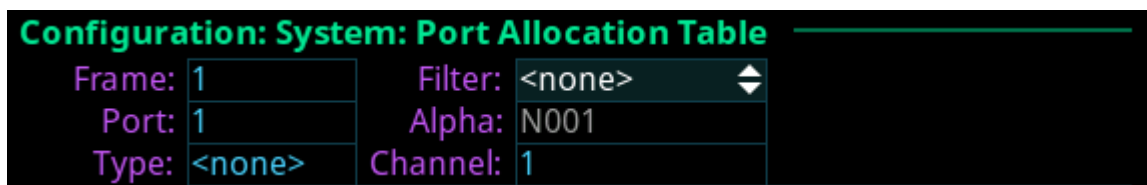

9. Rotating the right encoder knob, scroll to the **desired filter** (for example, AIO, 2W, OMNEO, RVON or <none>) to filter the ports.

**NOTE:** The Filter field is used to find certain types of ports quickly to either modify or delete assignments.

10. Click the **right encoder knob** to confirm the selection.  
*All the ports with the selected filter are scrollable.*
11. Rotating the right encoder knob, move the **focus to the Port field**.
12. Click the **right encoder knob**.  
*The Port field becomes active.*
13. Rotating the right encoder knob, scroll to the **port** to assign the desired allocation.
14. Click the **right encoder knob** to confirm the selection.  
*The Alpha field changes to display the default alpha. This field is read only. Changes this field can be made on the Ports screen (Intercom Setup | Alphas | Port).*
15. Rotating the right encoder knob, move the **focus to the Type field**.

16. Click the **right encoder knob**.  
*The Type field becomes active.*
17. Rotating the right encoder knob, select the **desired assignment type** (for example, AIO, 2W, OMNEO, RVON or <none>).
18. Click the **right encoder knob** to confirm the selection.
19. Rotating the right encoder knob, move the **focus to the Channel field**.
20. Click the **right encoder knob**.  
*The Channel field becomes active.*
21. Rotating the right encoder knob, scroll to the **desired channel**.

**NOTE:** OMNEO ports can only be unity mapped (for example, If port 16 is an OMNEO port, it must also be channel 16).

22. Click the **encoder knob** to confirm the selection.
23. Click the **left encoder knob** to exit the screen.  
*A Changes Made confirmation message appears.*

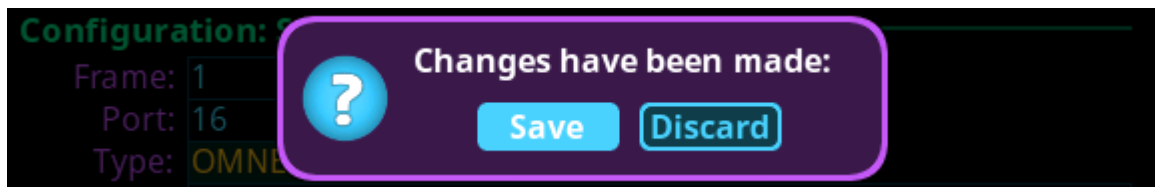

24. Click the **right encoder knob** to Save.  
OR  
Rotating the right encoder knob, move the focus to **Discard**, and then click the **encoder knob** to confirm the discard.

**NOTE:** Alternately, the left shaft encoder button can be clicked or the CLR button can be pressed to cancel this prompt and go back to editing on the underlying screen (for example, if the user is not ready to Save or Discard the modifications).

## Allocate Ports in AZedit

To allocate ports using AZedit, do the following:

1. From the Options menu, select **Port Allocation Table**.  
*The Port Allocation Table window appears.*

Port Allocation Table

Port	Alpha	Type	Channel	
2	N002	RVON	2	
3	N003	AIO	3	
4	N004	AIO	4	
5	N005	AIO	5	
6	N006	AIO	6	
7	N007	AIO	7	
8	N008	AIO	8	
9	N009	AIO	9	
10	N010	RVON	16	
11	N011	RVON	15	
12	N012	AIO	12	
13	N013	AIO	13	
14	N014	AIO	14	
15	N015	2W	CH A	
16	N016	2W	CH B	
17	N017	OMNEO	17	

**NOTE:** When *Port is unlicensed* is seen in the port allocation table, it means the port is not licensed for use and cannot be configured. For more on licenses, see “Licensing” on page 16.

2. From the Type column drop down menu, select the **device type** assigned to the port (for example, OMNEO, RVON, AIO, 2W, or <none>).
3. From the Channel column drop down menu, select the channel assignment for the device.
4. Once finished allocating the ports, click **Apply**.  
*The Send Port Allocation Table to Intercom window appears.*
5. Click **Proceed**.  
*The Port Allocation Table is sent to the intercom.*

**NOTE:** Duplicating channel assignments displays a highlighted warning that a *Duplicate Channel Allocation* has occurred. This must be fixed before proceeding.

---

## ***IFL Inter-Frame Linking (Multi-Frame Only)***

---

**IFL** (Inter-Frame Linking) is a system configuration in which multiple ODIN frames operate as a single intercom matrix. Using fiber optic IFL cables, up to eight ODIN frames can be inter-connected.

**NOTE:** Although IFL is only used for connecting two or more frames together, the IFL port status screen is accessible for single frame systems in case a second frame is connected at a later time.

The SFPs are sold separately. ODIN supports single mode and multimode SFP (Small Form-Factor Pluggable) Transceiver.

ODIN can operate using either mode, but for long distances, single mode is recommended.

**NOTE:** The minimum rate of the IFL SFP is 2.125 Gbps. Therefore, a standard Gigabit Ethernet SFP will not work.

ODIN frames can also be set up for IFL redundancy. This means if one link fails, audio is still available on the redundant link. ODIN has Primary and Secondary IFL connector sets located on the back panel of the frame that are used to set up IFL connection redundancy. This means the IFL connection has failover protection if one IFL connection becomes unresponsive or inactive.

---

**IMPORTANT:** IFL connection redundancy does not mean the frame and its setup is redundant. Only the connection between frames is protected from cable failure.

---

## Cabling IFL Between Two ODIN Frames

To set up a 2-frame IFL system, do the following:

1. On the rear panel of frame 1, connect one end of an IFL cable to the **PRI DOWNLINK** connector.
2. Connect the **other end of the IFL cable to the PRI UPLINK** on the rear panel frame 2.

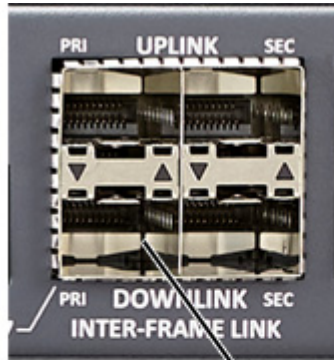

Frame 1

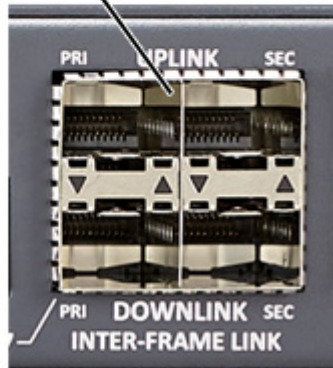

Frame 2

## For a redundant connection

3. On the rear panel of frame 1, connect one end of a second IFL cable to the **SEC DOWNLINK** connector.
4. Connect the **other end of the IFL cable to the SEC UPLINK** connector on frame 2.

**NOTE:** Additional redundant connections can be made from Frame 2 PRI Downlink to Frame 1 Uplink, forming a loop.

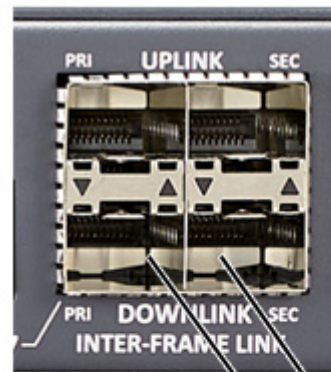

Frame 1

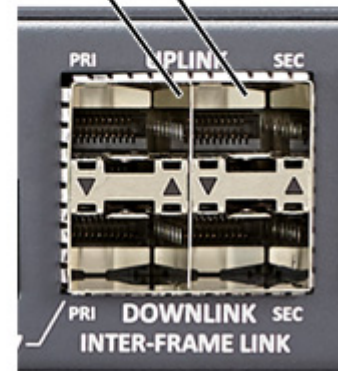

Frame 2

## Cabling IFL Between Three Or More ODIN Frames

Ring architecture is used when connecting three or more (up to a maximum of eight) ODIN frames via IFL. In a ring-wiring architecture, each frame has links to two other frames. These links are bi-directional<sup>1</sup>, meaning audio is passed in both directions; thus the system can be viewed as having two unidirectional rings. In one ring, the audio is sent clockwise from frame to frame, and in the other ring, the audio is sent counterclockwise.

When referring to a multi-frame system connected via IFL, the use of the terms upstream and downstream indicate the immediate frame above or below the current frame in the IFL system. For example, frame 1's downlink is frame 2; frame 2's downlink is frame 3. Since IFL uses ring architecture, the last frame in the system is linked to the first. So, the downlink from the last frame in the system will be to the uplink in the first frame.

To set up a 3-to 8-frame IFL system, do the following:

### For Non-Redundant Connection

1. On the rear panel of frame 1, connect one end of an IFL cable to the **PRI DOWNLINK** connector .
2. Connect the **other end of the IFL cable to the PRI UPLINK** on the rear panel of frame 2.
3. Using a second IFL cable, connect one end of the **IFL cable to the PRI DOWNLINK** connector on frame 2.
4. Connect the **other end of the second IFL cable to the PRI UPLINK** connector on frame 3.
5. Repeat **step 3** and **step 4** for additional ODIN frames (maximum eight frames).

**NOTE:** For simple redundant audio, connect the last frame to the frame 1. If an audio path is available, the system will use it.

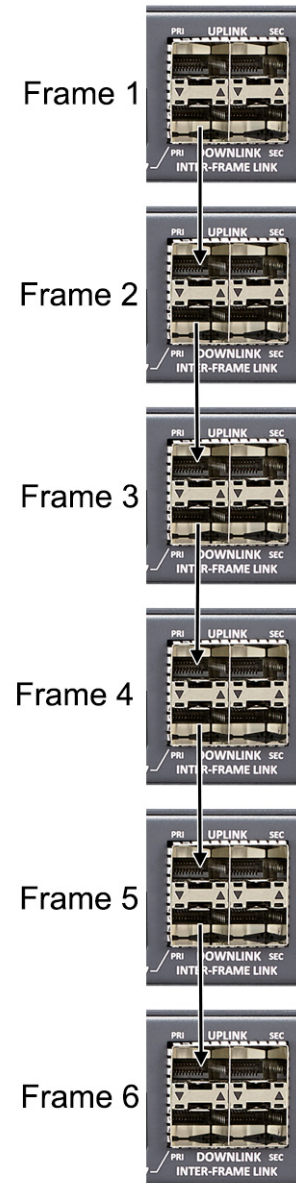

1. One IFL cable provides bi-directional audio.

---

*For A Redundant Connection*

---

**IMPORTANT:** IFL connection redundancy does not mean the frame and its setup is redundant. Only the connection between frames is protected from cable failure.

---

1. On the rear panel of frame 1, connect one end of an **IFL cable to the PRI DOWNLINK connector**.
2. Connect the **other end of the IFL cable to the PRI UPLINK connector** on the rear panel of frame 2.
3. Using a second IFL cable, connect one end of the **IFL cable to the SEC DOWNLINK connector** on frame 1.
4. Connect the **other end of the IFL cable to the SEC UPLINK connector** on frame 2.
5. Using a third IFL cable, connect one end of the **IFL cable to the PRI DOWNLINK connector** on frame 2.
6. Connect the **other end of the second IFL cable to the PRI UPLINK connector** on frame 3.
7. Using a fourth IFL cable, connect one end of the **IFL cable to the SEC DOWNLINK connector** on frame 2.
8. Connect the **other end of the IFL cable to the SEC UPLINK connector** on frame 3.
9. Repeat **steps 5 through 8** for additional frames (maximum eight frames).
10. On the last frame, connect **one end of an IFL cable to the PRI DOWNLINK connector**.
11. Connect the **other end of the IFL cable to the PRI UPLINK connector** on frame 1.
12. On the last frame, connect **one end of an IFL cable to the SEC DOWNLINK connector**.
13. Connect the **other end of the IFL cable to the PRI UPLINK connector** on the frame 1.



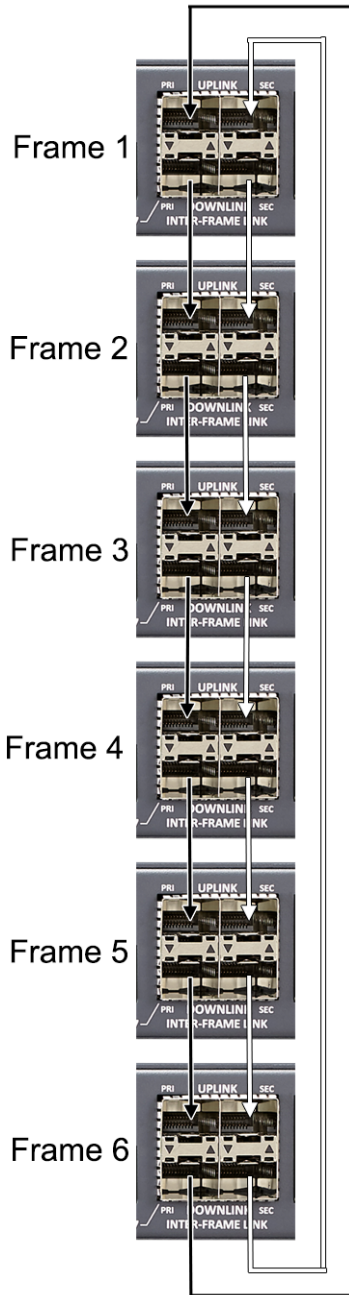

## Checking the IFL Status (Front Panel)

To display the IFL connection status from the front panel, do the following:

1. Rotating the right encoder knob, navigate to the **Status icon**.
2. Click the **right encoder knob**.  
*The Status Menu appears.*
3. Rotating the right knob, navigate to the **Intercom menu icon**.
4. Click the **right encoder knob**.  
*The Intercom menu appears.*
5. Rotating the right encoder knob, navigate to the **IFL icon**.
6. Click the **right encoder knob**.  
*The IFL screen appears.*

**NOTE:** For more information, see “IFL” on page 107.

Status: Intercom: IFL			
Frame: 4			
Primary Uplink			
Connected:	✓	Fault:	-
To Frame:	3	Tx Messages:	542
To Link:	Primary Downlink	Rx Messages:	536
IP Address:	192.168.0.30	Rx Errors:	-
SFP Installed:	✓	SFP Tx Fault:	-
Tx Power:	0.282 mW	Rx Power:	0.396 mW
Secondary Uplink			
Connected:	✓	Fault:	-
To Frame:	3	Tx Messages:	769
To Link:	Secondary Downlink	Rx Messages:	762
IP Address:	192.168.0.30	Rx Errors:	-
SFP Installed:	✓	SFP Tx Fault:	-
Tx Power:	0.285 mW	Rx Power:	0.634 mW
Primary Downlink			
Connected:	✓	Fault:	-
To Frame:	5	Tx Messages:	758
To Link:	Primary Uplink	Rx Messages:	662
IP Address:	192.168.0.50	Rx Errors:	-
SFP Installed:	✓	SFP Tx Fault:	-
Tx Power:	0.278 mW	Rx Power:	0.588 mW
Secondary Downlink			
Connected:	✗	Fault:	-
To Frame:	-	Tx Messages:	-
To Link:	-	Rx Messages:	1358
IP Address:	-	Rx Errors:	-
SFP Installed:	✓	SFP Tx Fault:	-
Tx Power:	0.285 mW	Rx Power:	0.849 mW

### Checking the IFL Status (AZedit)

To check the IFL Status from AZedit, do the following:

1. From the Status menu, select **Inter-Frame Link**.  
The IFL Status window appears.

The screenshot shows the 'AZedit - [ONLINE] - IFL Status' window. The window title bar includes 'File', 'Online', 'Authentication', 'Edit', 'View', 'System', 'Alphas', 'Status', 'Options', 'Logging', and 'Help'. Below the title bar is a standard Windows-style toolbar with various icons. The main content area is a table with the following columns: 'From Frame:Link', 'Status', 'To Frame:Link', 'IP Address', 'Tx Messages', 'Rx Messages', 'Rx Errors', and 'Fault Info'. The table lists 28 rows of data, showing various link configurations and their associated statistics.

From Frame:Link	Status	To Frame:Link	IP Address	Tx Messages	Rx Messages	Rx Errors	Fault Info
1:Primary uplink	-	-	-	-	-	-	-
1:Secondary uplink	-	-	-	-	-	-	-
1:Primary downlink	-	-	-	-	-	-	-
1:Secondary downlink	-	-	-	-	-	-	-
2:Primary uplink	-	-	-	-	-	-	-
2:Secondary uplink	-	-	-	-	-	-	-
2:Primary downlink	-	-	-	-	-	-	-
2:Secondary downlink	-	-	-	-	-	-	-
3:Primary uplink	-	-	-	-	-	-	-
3:Secondary uplink	-	-	-	-	-	-	-
3:Primary downlink	-	-	-	-	-	-	-
3:Secondary downlink	-	-	-	-	-	-	-
4:Primary uplink	-	-	-	-	-	-	-
4:Secondary uplink	-	-	-	-	-	-	-
4:Primary downlink	-	-	-	-	-	-	-
4:Secondary downlink	-	-	-	-	-	-	-
5:Primary uplink	-	-	-	-	-	-	-
5:Secondary uplink	-	-	-	-	-	-	-
5:Primary downlink	OK	6:Primary uplink	192.168.0.60	5459	16766	0	-
5:Secondary downlink	OK	6:Secondary u...	192.168.0.60	5439	16773	0	-
6:Primary uplink	OK	5:Primary down...	192.168.0.50	64909	41616	0	-
6:Secondary uplink	OK	5:Secondary do...	192.168.0.50	64852	41312	0	-
6:Primary downlink	OK	7:Primary uplink	-	70057	70004	0	-
6:Secondary downlink	OK	7:Secondary u...	-	69859	69492	0	-
7:Primary uplink	-	-	-	-	-	-	-
7:Secondary uplink	-	-	-	-	-	-	-
7:Primary downlink	OK	8:Primary uplink	192.168.0.80	126829	119657	0	-
7:Secondary downlink	-	-	-	-	-	-	-

## Frame Mapping (Multi-Frame Only)

Frame Mapping is used to assign the position of each frame in a multi-frame intercom system. The frame order determines the port range assigned. For example, when mapping a 2-frame system, with each frame having 128 ports, the first frame is given ports 1 through 128. The second frame is assigned ports 129 through 256.

To order the frames in a system, a frame mapping table must be configured. Frame mapping can be done from either the front panel of ODIN or by using the AZedit configuration software.

### Frame Mapping (Front Panel)

To map frames from ODIN front panel, to the following:

1. Rotating the right encoder knob, navigate to the **Configuration icon**.
2. Click the **right encoder knob**.  
*The Configuration Menu appears.*
3. Rotating the right knob, navigate to the **System menu icon**.
4. Click the **right encoder knob**.  
*The System menu appears.*
5. Rotating the right encoder knob, navigate to the **Frame Mapping Table menu icon**.
6. Click the **right encoder knob**.  
*The Frame Mapping Table appears.*

**IMPORTANT:** The IP Address and MAC Address of the current frame (shown in gray) cannot be modified from this screen.

	IP Address	MAC Address
Frame 1:	192.168.0.10	00:0b:7c:ff:ff:a2
Frame 2:	192.168.0.20	00:0b:7c:ff:ff:9a
Frame 3:	192.168.0.30	00:0b:7c:ff:ff:96
Frame 4:	192.168.0.40	00:1c:44:0b:a0:00
Frame 5:	192.168.0.50	00:1c:44:0b:a0:0e
Frame 6:	192.168.0.60	00:1c:44:0b:a0:0d
Frame 7:	192.168.0.70	00:1c:44:0b:a0:07
Frame 8:	192.168.0.80	00:00:00:00:00:00

7. Edit the **IP Address** to reorder the frames in the intercom.

**NOTE:** Pressing SHIFT + UP/DOWN moves the currently highlighted entry up or down.

## Frame Mapping (AZedit)

To map frames from AZedit, do the following:

1. From the Options menu, select **Frame Mapping**.  
*The Frame Mapping Table window appears.*

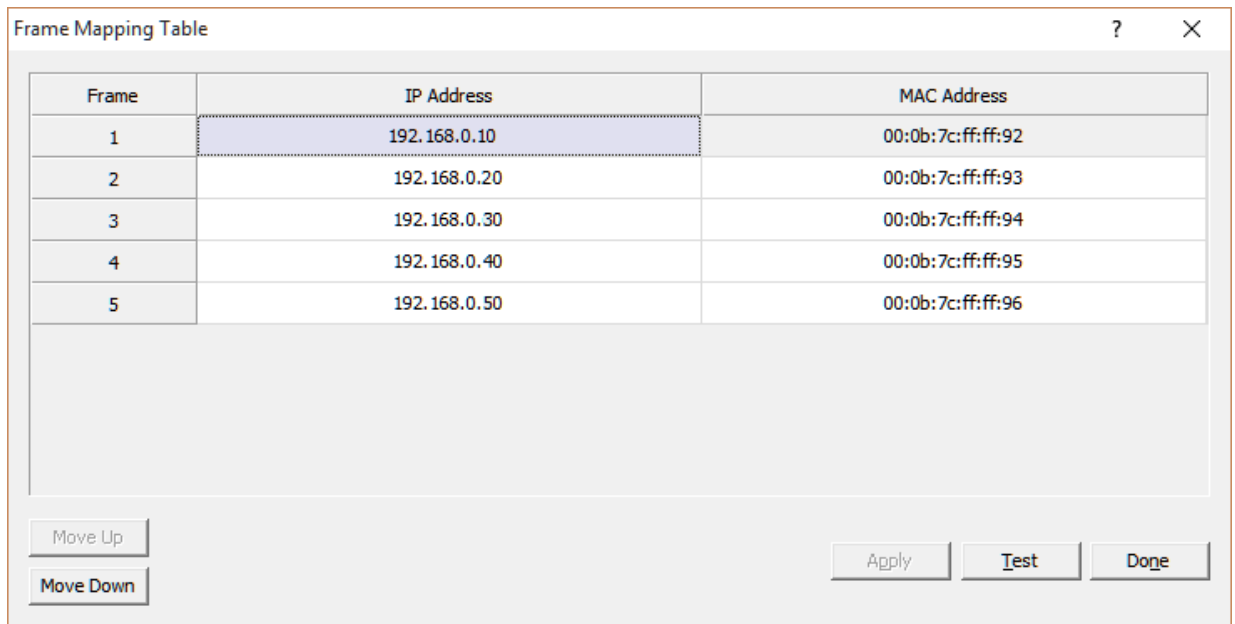

2. Click the **Browse icon** to select frame to add to the table.

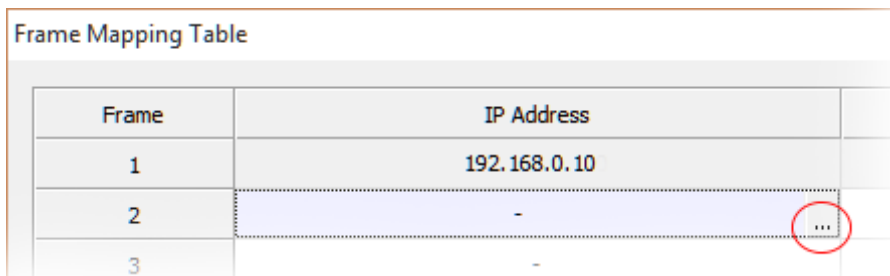

*The Select Frame window appears.*

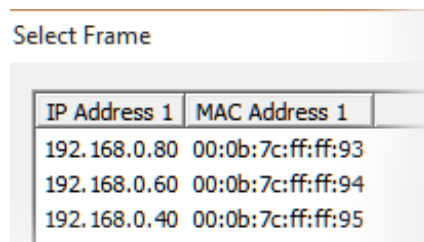

3. Select the **frame** to add to the frame mapping table.
4. Click the **OK button**.  
*The Select Frame window closes and the frame information is added to the frame mapping table.*
5. Click the **Test button** to validate the table.  
*A valid or not valid message appears.*
6. Click **OK**.  
*The message closes.*
7. Click **Apply**.  
*The modifications are applied to the frame mapping table.*

**8. Click Done.**

*The Frame Mapping Table window closes.*

Move Up/Move Down Button

The **Move Up** and **Move Down** button is used to set the frame order in the system. The order in which the frames are set determines the ports that are assigned to each frame.

---

## ***RSTP***

---

**RSTP** (Rapid Spanning Tree Protocol) is a fault tolerant Ethernet protocol, which allows the system to be set up with multiple Ethernet connection paths to the same access points. This provides a redundant connection if one connection path fails. The RSTP connection paths prevent the possibility of packets getting into an infinite loop.

RSTP is an IEEE standardized network protocol (802.1w) ensuring a loop-free topology for an Ethernet LAN (Local Area Network), evolved from STP (Spanning Tree Protocol). OMNEO fully supports RSTP IEEE802.1w. When using switches that support this technology, it is necessary to adjust the RSTP parameters of the switch according to the following:

*Hello Time: 9 seconds*

*Maximum Age: 22 seconds*

*Forward Delay: 30 seconds*

This is supported by the major switch brands.

# Installation and Maintenance

---

## Introduction

The ODIN Digital Intercom is a highly scalable intercom system in a 1RU (Rack Unit) package. Up to eight ODIN frames can be interconnected via optical Inter-Frame Links creating a single matrix with up to 1024 ports.

---

**IMPORTANT:** ODIN acts as a common connection point for the ground connections associated with each power supply (2 total). If a ground difference exists between the two power supply inputs to ODIN, audio noise or performance degradation may result. If possible, avoid powering ODIN with sources having different ground potentials.

---

**CAUTION:**

- If installed in a closed or multi-unit rack assembly, the operating ambient temperature of the rack environment may be greater than the room ambient temperature. Therefore, special consideration should be given to installing the equipment in an environment compatible with the specified maximum ambient operating temperature.
- Minimum 4" clearance on left and right sides of ODIN is required to keep the fan area unobstructed and ensure proper ventilation.
- ODIN is to be connected to mains socket outlet with a protective earth connection. Particular attention should be given to power supply connections other than direct connection to the mains socket. This includes using power strips with earth grounding.
- Consideration should be taken to ensure the mains power supply current and voltage meet the ratings specified on the equipment name plate.

---

## Requirements

<i>AZedit</i> .....	<i>v5.4.0 or later</i>
<i>IPedit</i> .....	<i>v3.6.0 or later</i>
<i>KP Series</i> .....	<i>v2.1.4 or later</i>
<i>KP Series-RVON</i> .....	<i>v1.5.0 or later</i>
<i>RVON-KP / RVON-IO / RVON-16 / RVON-C</i> .....	<i>v2.7.0 or later</i>
<i>OMI</i> .....	<i>v6.2.0 or later</i>
<i>OKI</i> .....	<i>v6.1.2 or later</i>
<i>OEI-2</i> .....	<i>v2.10 or later</i>
<i>ROAMEO</i> .....	<i>v8.1.1 or later</i>
<i>TrunkEdit</i> .....	<i>v1.8.1 or later</i>
<i>Trunk Supervisor</i> .....	<i>v1.9.2 or later</i>

**NOTE:** For downloading instructions, see "Firmware" on page 73.

## Network Port Cabling

To cable ODIN to a network, do the following:



1. On the rear panel of ODIN, connect an **Ethernet cable to the J8 CONTROL** connector.
2. If using OMNEO over Ethernet, connect an **RJ-45 cable to the J10 OMNEO PRI(RJ-45)** connector.
3. If using OMNEO over fiber, connect an **SFP fiber connector to the J11 PRI (SFP)** connector.
4. If using RVON, connect an **Ethernet cable to the J8 RVON** connector.

## Network Port Configuration

To access the **Network Configuration menu**, do the following:

1. On the rear panel of ODIN, connect a **power cord to PS1, PS2 or both**.

**NOTE:** When the power supply is powered on and only one power supply is connected, an alarm is generated.

2. On the front panel of ODIN, press the **PS1, PS2 or both buttons**.

*The frame powers on and the display turns on and the Home screen appears.*

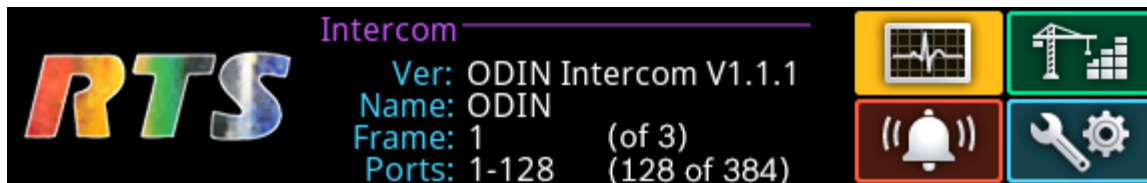

3. Rotating the right encoder knob, navigate to the **Configuration icon**.

4. Click the **right encoder knob**.

*The Configuration menu appears.*



5. Rotating the right encoder knob, navigate to the **Network icon**.

6. Click the **right encoder knob**.

*The Network menu appears.*

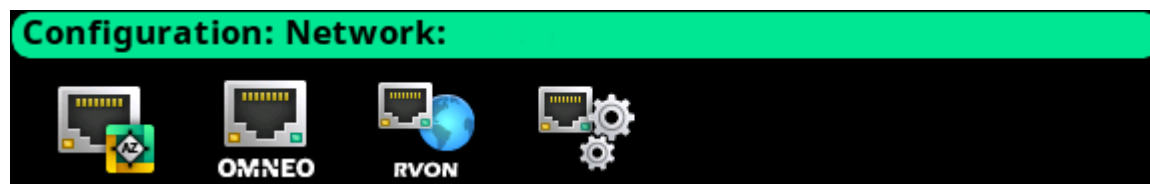



## Configure the Control Port Interface

The **Control Port** screen is used to configure the network interface used for AZedit, Trunk Master, and frame-to-frame communications in multi-frame systems

To **configure the Control Port interface**, do the following:

1. Rotating the right encoder knob, navigate to the **Control Port icon**.
2. Click the **right encoder knob**.  
*The Control Port Configuration screen appears.*



**NOTE:** The default IP Address is 192.168.0.10.

3. In the IP Address field, enter the **IP Address** of the Control Port.
4. In the Netmask field, enter the **Netmask**, if different than what is shown.
5. In the Gateway field, enter the **gateway address**, if applicable.
6. In the DNS Server field, enter the **DNS server Address**, if applicable.
7. Click the left encoder knob to exit the **Control Port Screen**.  
*A confirmation to save or discard changes appear.*
8. Rotate the **right encoder knob** to the desired action.
9. Click the **right encoder knob** to confirm the selection.
10. Click the left encoder knob to exit the **Control Port Screen**.  
*The Network Menu icons appear.*

## Configure the OMNEO Interface

To **configure the OMNEO interface from the front panel**, do the following:

1. Rotating the right encoder knob, navigate to the **OMNEO icon**.
2. Click the **right encoder knob**.  
*The OMNEO Configuration Screen appears.*

**NOTE:** By default, the OMNEO interfaces have a link local address. If there is a DHCP server available, the IP Address is provided by the DHCP server. This configuration should be done only if the user wants to set a Static IP Address for the OMNEO interface.

This configuration is also used to change the device name, or change the RSTP or Glitch Free settings (even if DHCP is being used).

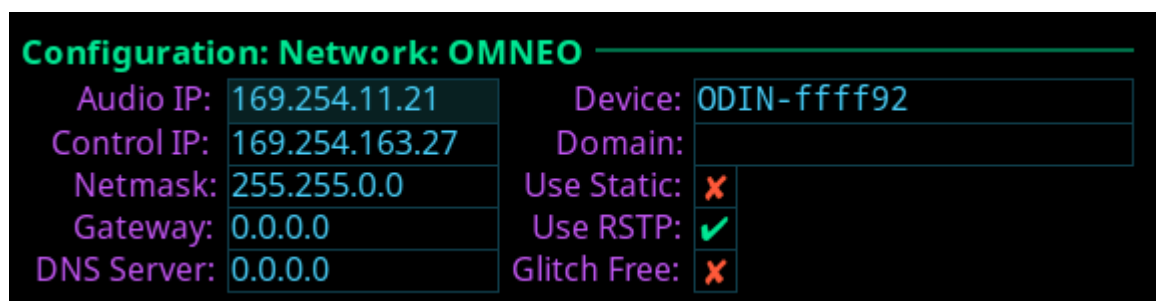

3. Select the **Use Static check box** to enable Static IP addressing.

**NOTE:** If the Use Static check box is not selected, DHCP/Link-local is used. Some of the remaining fields are automatically populated.

4. In the Audio IP field, enter the **IP address** used to transmit and receive audio across the network.

**NOTE:** The Audio IP address and the Control IP address should be in the same subnet. ODIN displays a warning message if these addresses are not on the same subnet.

5. In the Control field, enter the **IP address** used by the OMNEO controller to access the network.
6. In the Netmask field, enter the **netmask address** for the OMNEO interfaces.
7. In the Gateway field, enter the **gateway address** for the OMNEO interfaces, if applicable.
8. In the DNS Server field, enter the **DNS (Domain Name Server) Server address** to which OMNEO has access.
9. In the Device field, enter a **recognizable name** for the OMNEO network connection.
10. Rotating the right encoder knob, scroll to the **first character** of the device name.
11. Click the **right encoder knob** to advance to the next character.
12. Repeat **step 9** and **step 10** until the device name is entered.
13. When finished entering the Device Name, double-click the **right encoder knob**.  
*The Device field turns yellow (modification made).*
14. In the Domain field, enter the **domain**. By default, the domain is left blank.
15. Click the **left encoder knob** to exit the OMNEO screen.  
*The Network Menu Icons appear.*

### Configure the RVON Interface

To **configure the RVON interface from the front panel**, do the following:

1. Rotating the right encoder knob, navigate to the **RVON icon**.
2. Click the **right encoder knob**.  
*The RVON Configuration Screen appears.*



3. In the IP Address field, enter the **IP address** used by the RVON controller to access the network.
4. In the Netmask field, enter the **netmask address** for the RVON interface.
5. In the Gateway field, enter the **gateway address** for the RVON interface, if applicable.

### Configure the Management Port

To **configure the management port**, do the following:

1. Rotating the right encoder knob, navigate to the **Management Port icon**.
2. Click the **right encoder knob**.  
*The Management Port Screen appears.*

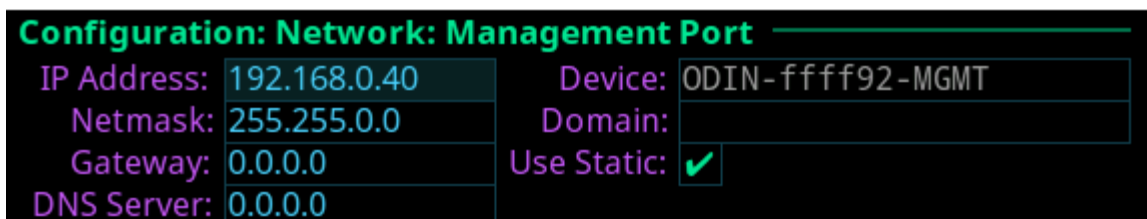

3. Select the **Use Static check box** to enable Static IP Addressing.

**NOTE:** If the Use Static check box is not selected, DHCP/Link-local is used. Some of the remaining fields are automatically populated.

4. In the IP Address field, enter the **IP address** used by the port to access the network.
5. In the Netmask field, enter the **netmask address** for the management port.
6. In the Gateway field, enter the **gateway address** for the management port, if applicable.
7. In the DNS Server field, enter the **DNS (Domain Name Server) Server**.

**NOTE:** The Device field cannot be modified for the management port. The device name is the same as the OMNEO name with -MGMT appended to the end of the name.

## Intercom Configuration

### Port Allocation

The **Port Allocation Table** is used to assign port types (OMNEO, RVON, AIO, 2W, etc...) to each intercom port, and to map the physical hardware (for analog ports) to specific intercom ports. Analog port devices, such as AIO and 2-wire devices, and network port devices, such as OMNEO, can be mapped to any port in the intercom.

- To allocate ports from the front panel of ODIN, see “Allocate Ports from the Front Panel of ODIN” on page 38.
- To allocate ports in AZedit, see “Allocate Ports in AZedit” on page 40.

### Port Configuration

#### Connecting 2W Devices to ODIN

To **connect a 2W device to ODIN**, do the following:

1. Using the Port Allocation table, assign the **device channel** to CH A or CH B. “Allocate Ports from the Front Panel of ODIN” on page 38.
2. Rotating the right encoder knob, navigate to the **Configuration icon**.
3. Click the **right encoder knob**.  
*The Configuration Menu appears.*

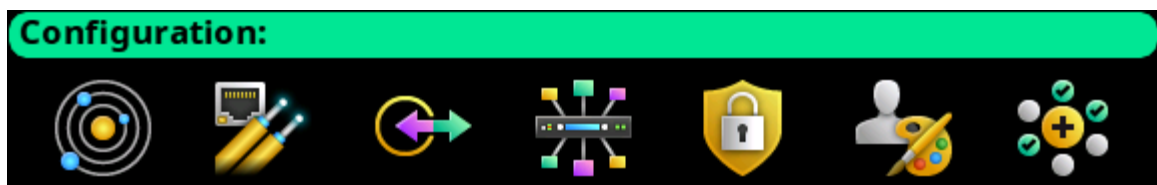

4. Rotating the right knob, navigate to the **Ports menu icon**.
5. Click the **right encoder knob**.  
*The Ports menu appears.*



6. Rotating the right encoder knob, navigate to the **2W menu icon**.

- Click the **right encoder knob**.  
*The 2W Channels screen appears.*

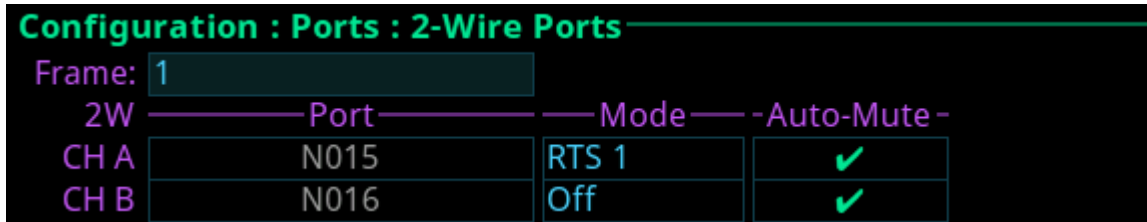

- Rotating the right encoder knob, navigate to the **Mode** field.
- Click the **right encoder knob**.  
*The Mode field becomes active.*
- Rotating the right encoder knob, select the **Mode**.
- Click the **right encoder knob**.  
*The Mode field is changed.*
- Rotating the right encoder knob, navigate to the **Auto-Mute** field.
- Click the **right encoder knob**.  
*The Auto-Mute field becomes active.*
- Press the **SEL button** to enable/disable Auto-Mute.  
OR  
Click the **right encoder knob** to disable Auto-Mute.

**NOTE:** For more information, see “2-Wire” on page 94.

- Click the **right encoder knob**.  
*The Auto-Mute field turns yellow.*
- Click the **left encoder knob** to exit the screen.  
*A Changes Made confirmation message appears.*

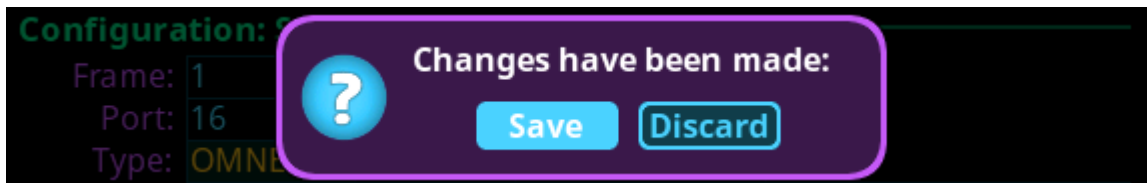

- Click the **right encoder knob** to save.  
OR  
Rotating the right encoder knob, move the focus to **Discard**, and then click the **encoder knob** to confirm the discard.

**NOTE:** Alternately, the left shaft encoder button can be clicked or the CLR button can be pressed to cancel this prompt and go back to editing on the underlying screen (for example, if the user is not ready to Save or Discard the modifications).

- On the back of ODIN, connect the **2W device** to the CH A or CH B connector configured in the Port Allocation Table.

### Connecting Analog Keypanels to ODIN

To connect an analog keypad to ODIN, do the following:

- Using the Port Allocation table, assign the **device channel** to the AIO port. See, “Allocate Ports from the Front Panel of ODIN” on page 38.
- On the back of ODIN, connect the **keypanel** to the AIO connector.

**IMPORTANT:** The AIO port assigned in the Port Allocation Table must match the AIO port on the rear panel of ODIN.

### Connecting OMNEO devices to ODIN

To connect OMNEO devices to ODIN, do the following:

- Using the Port Allocation table, assign the **device channel**. See “Allocate Ports from the Front Panel of ODIN” on page 38.
- Rotating the right encoder knob, navigate to the **Configuration icon**.
- Click the **right encoder knob**.  
*The Configuration Menu appears.*

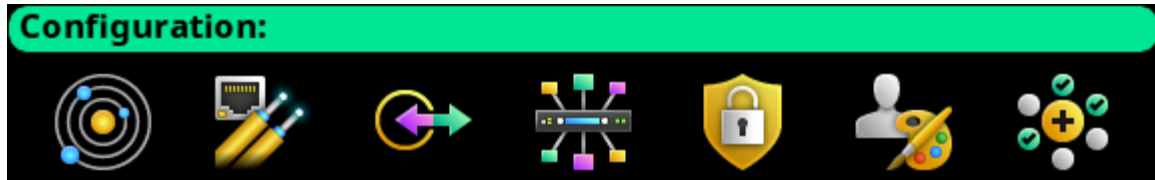

- Rotating the right knob, navigate to the **Ports menu icon**.
- Click the **right encoder knob**.  
*The Ports menu appears.*



- Rotating the right encoder knob, navigate to the **OMNEO menu icon**.
- Click the **right encoder knob**.  
*The OMNEO Channels screen appears.*



**IMPORTANT:** If the intercom system contains only one ODIN frame, the Frame field is not displayed. If the intercom system contains multiple ODIN frames, the Frame field activates allows ports in other frames to be selected and configured. While the Frame field is highlighted, press the **right encoder knob** to activate the field. Once activated, turn the right encoder knob to select another frame in the system.

- Rotating the right encoder knob, navigate to the **Port field**.
- Click the **right encoder knob**.  
*The Port field becomes active.*
- Rotating the right encoder knob, scroll to the **desired port**.
- Click the **right encoder knob**.  
*The Port field is changed.*
- Rotating the right encoder knob, navigate to the **Device Name field**.
- Click the **right encoder knob**.  
*The Device Name field becomes active.*
- Enter the **Device Name** of the partner device to connect to this port.
- When finished entering the device name, click the **right encoder knob**.  
*The Device Name field turns yellow (modification made).*
- Rotating the right encoder knob, navigate to the **Device Type field**.

17. Click the **right encoder knob**.  
*The Device Type field becomes active.*
18. Rotating the right encoder knob, scroll to the **OMNEO device type** of the partner device.
19. Click the **right encoder knob**.  
*The Device Type field turns yellow.*
20. Rotating the right encoder knob, navigate to the **channel field**.
21. Click the **right encoder knob**.  
*The Channel field becomes active.*
22. Rotating the right encoder knob, scroll to the **Channel** on the partner device.
23. Click the **right encoder knob**.  
*The Channel field turns yellow.*
24. (Optional) In the Description field, enter a **description** for this port connection.
25. (Optional) In the RX Latency field, select the latency to use for this connection (1 ms is recommended for best quality).
26. Click the **left encoder knob** to exit the screen.  
*A Changes Made confirmation message appears.*

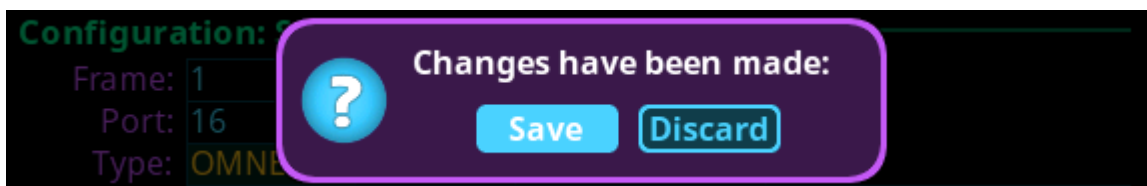

27. Click the **right encoder knob** to save.  
OR  
Rotating the right encoder knob, move the focus to **Discard**, and then click the **encoder knob** to confirm the discard.

**NOTE:** Alternately, the left shaft encoder button can be clicked or the CLR button can be pressed to cancel this prompt and go back to editing on the underlying screen (for example, if the user is not ready to Save or Discard the modifications).

### Connecting RVON Devices to ODIN

To **connect RVON devices to ODIN**, do the following:

1. Using the Port Allocation table, assign the **device channel**. See “Allocate Ports from the Front Panel of ODIN” on page 38.
2. Rotating the right encoder knob, navigate to the **Configuration icon**.
3. Click the **right encoder knob**.  
*The Configuration Menu appears.*



4. Rotating the right knob, navigate to the **Ports menu icon**.
5. Click the **right encoder knob**.  
*The Ports menu appears.*



6. Rotating the right encoder knob, navigate to the **RVON menu icon**.

7. Click the **right encoder knob**.  
*The RVON Channels screen appears.*

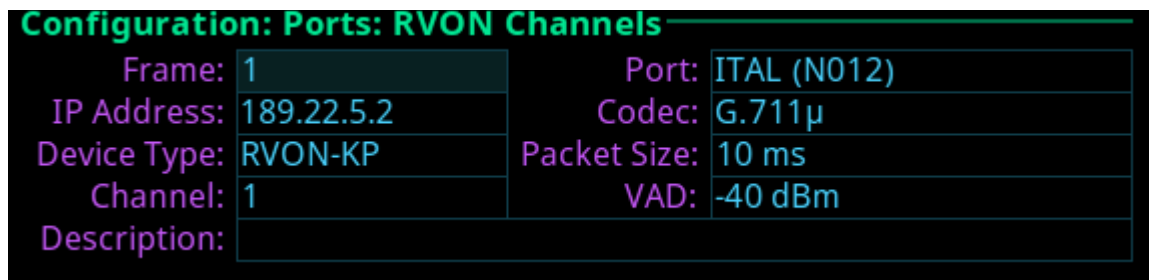

**IMPORTANT:** If the intercom system contains only one ODIN frame, the Frame field is not displayed. If the intercom system contains multiple ODIN frames, the Frame field activates allows ports in other frames to be selected and configured. While the Frame field is highlighted, press the **right encoder knob** to activate the field. Once activated, turn the right encoder knob to select another frame in the system.

8. Rotating the right encoder knob, navigate to the **Port field**.
9. Click the **right encoder knob**.  
*The Port field becomes active.*
10. Rotating the right encoder knob, scroll to the **desired port**.
11. Click the **right encoder knob**.  
*The Port field is changed.*
12. Rotating the right encoder knob, navigate to the **IP Address field**.
13. Click the **right encoder knob**.  
*The IP Address field becomes active.*
14. Enter the **IP Address** of the partner device to connect to this port.
15. When finished entering the device name, click the **right encoder knob**.  
*The IP Address field turns yellow (modification made).*
16. Rotating the right encoder knob, navigate to the **Codec field**.
17. Click the **right encoder knob**.  
*The Codec field becomes active.*
18. Rotating the right encoder knob, select the **codec** to use.
19. Click the **right encoder knob**.  
*The Codec field becomes yellow (modification made).*
20. Rotating the right encoder knob, navigate to the **Device Type field**.
21. Click the **right encoder knob**.  
*The Device Type field becomes active.*
22. Rotating the right encoder knob, scroll to the **RVON device type** of the partner device.
23. Click the **right encoder knob**.  
*The Device Type field turns yellow.*
24. Rotating the right encoder knob, navigate to the **Packet Size field**.
25. Click the **right encoder knob**.  
*The Packet Size field becomes active.*
26. Rotating the right encoder knob, select the **packet size** to use.
27. Click the **right encoder knob**.  
*The Packet Size field becomes yellow (modification made).*
28. Rotating the right encoder knob, navigate to the **channel field**.
29. Click the **right encoder knob**.  
*The Channel field becomes active.*
30. Rotating the right encoder knob, scroll to the **Channel** on the partner device.
31. Click the **right encoder knob**.  
*The Channel field turns yellow.*

32. Rotating the right encoder knob, navigate to the **VAD field**.
33. Click the **right encoder knob**.  
*The VAD field becomes active.*
34. Rotating the right encoder knob, select the **VAD threshold level to use or to Off**.
35. Click the **right encoder knob**.  
*The VAD field becomes yellow (modification made).*
36. (Optional) In the Description field, enter a **description** for this port connection.
37. Click the **left encoder knob** to exit the screen.  
*A Changes Made confirmation message appears.*

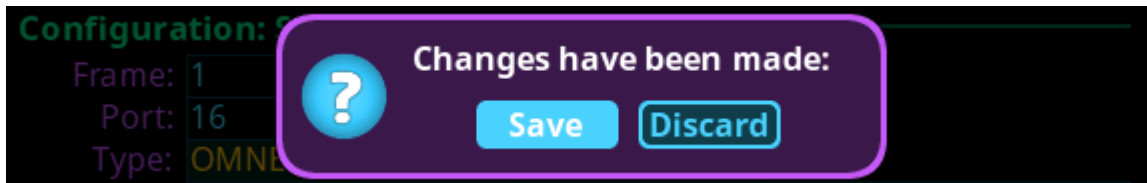

38. Click the **right encoder knob** to save.  
OR  
Rotating the right encoder knob, move the focus to **Discard**, and then click the **encoder knob** to confirm the discard.

**NOTE:** Alternately, the left shaft encoder button can be clicked or the CLR button can be pressed to cancel this prompt and go back to editing on the underlying screen (for example, if the user is not ready to Save or Discard the modifications).

### *Adding devices to the Device Catalog in IPedit*

To add an ODIN frame to IPedit, do the following:

1. Open **IPedit**.
2. From the Device menu, select **Add**.  
*The Add Devices Window appears, open to the Search tab.*
3. Select **one or more available devices**.  
*The Add button becomes active.*

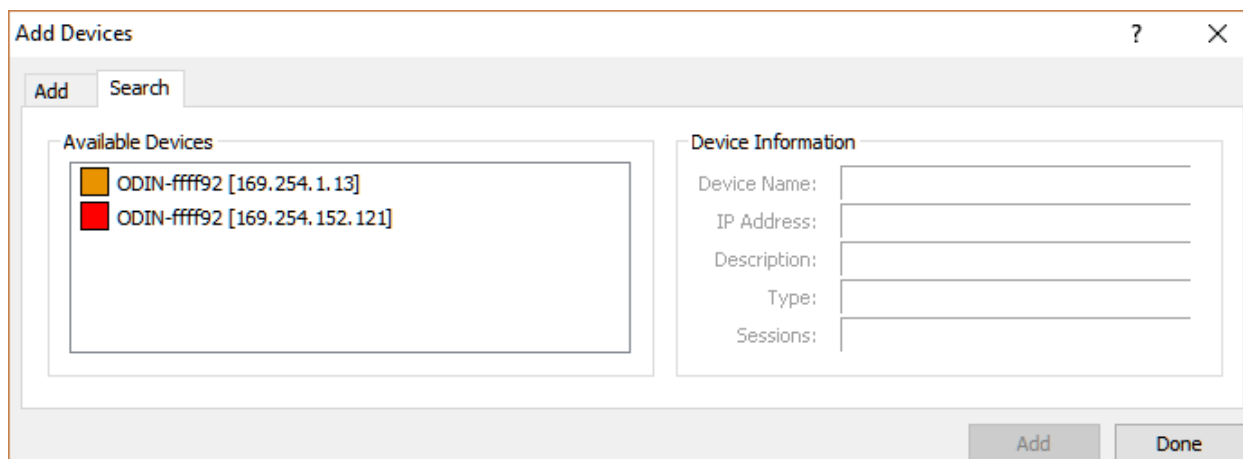

**NOTE:** ODIN (OMNEO) and ODIN-R (RVON) device types are shown as separate devices in IPedit. The OMNEO and RVON interfaces may be on the same network (in which case IPedit can talk to both devices at the same time) or, the network interfaces may be on separate networks (in which case an IPedit session needs to be run on each network and each session sees either ODIN or ODIN-R, but not both), unless the PC has two network cards (one on each network) or the two networks are routable via a gateway.

4. Click the **Add button**.  
*The selected devices appear in the device catalog in the left panel.*
5. Click the **Done button**.  
*The Add Devices window closes.*



### *Configure OMNEO Channel for ODIN using IPedit*

To **configure ODIN using IPedit**, do the following:

**NOTE:** The Destination Type does not need to be selected if using the Browse window to select the device. It fills the type and IP Address automatically. The type can be OKP, OKI, OEI, OAP, OMI, or another ODIN.

Using the Channel Configuration Pane

1. In the Destination Device Name field, click the **...** **button**.  
*The Discovered Devices Window appears.*
  - a. Expand the **tree** to view the destination devices available.
  - b. From the expanded tree, select the desired **device** for the destination.
  - c. Click **OK**.

OR

*If manually configuring:*

In the Destination Device Name field, enter the **name of the device** to which the channel will connect.

- a. From the Destination Type drop down menu, select the **type of device** to which to connect (for example OKP, OKI, OEI, OMI, or another ODIN).
2. From the Destination Channel drop down menu, select the **channel** to which ODIN connects.
3. (Optional) In the Channel Description field, enter a **channel description**.

Using the Device Configuration Pane

4. (Optional) In the Description field, enter a **description for ODIN**.
5. Send the **changes** to ODIN.

### *Configure an OMNEO Keypanel to connect to ODIN*

To **configure an OMNEO keypanel to accept a connection offer from an ODIN intercom**, do the following:

1. On the OMNEO keypanel, navigate to the OMNEO Offers | Keypanel menu, select **OKP**.
2. Press the **SEL button**.  
*A list of available OMNEO connection offers appear.*
3. Using the AUX/MENU shaft encoder, select the **OMNEO connection** to use.  
*An arrow appears next to the device.*
4. Press **CLR** to exit menu mode.

### *Configure RVON Channel for ODIN using IPedit*

To **configure ODIN RVON using IPedit**, do the following:

1. From the Device Catalog, select the **ODIN-R device**.

Using the Channel Configuration Pane

2. (Optional) In the Channel Description field, enter a **channel description**.
3. From the Destination Type drop down menu, select the **destination device type**.
4. In the Destination IP Address field, enter the **IP Address of the destination device**.
5. From the Destination Channel drop down menu, select the **channel** to which ODIN connects.
6. From the Coding Algorithm drop down menu, select the **appropriate codec**.
7. From Audio/Packet drop down menu, select the **audio packet size**.
8. (Optional) Select the **VAD check box**, if applicable.

Using the Device Configuration Pane

9. (Optional) In the Description field, enter a **description for RVON**.
10. Send the **changes** to ODIN.

### *Configure an RVON Keypanel to connect to ODIN*

To **configure an RVON keypanel to accept a connection offer from an ODIN intercom**, do the following:

1. On the keypanel, navigate to the RVON Offers | Keypanel menu, select the **Matrix connection type** you want to use.
2. Press the **SEL button**.  
*A list of available RVON connection offers appear.*
3. Using the AUX/MENU shaft encoder, select the **RVON connection** to use.  
*An arrow appears next to the device.*
4. Press **CLR** to exit menu mode.

### *Add Keypanels to the Device Catalog in IPedit*

**NOTE:** The following is an example of connecting an OKP to ODIN.

To **add the keypanel to IPedit**, do the following:

1. Open **IPedit**.
2. From the Device menu, select **Add**.  
*The Add Devices Window appears, open to the Search tab.*
3. Select the **keypanel**.  
*The Add button becomes active.*
4. Click the **Add button**.  
*The OKP-2/8 appears in the device catalog in the left panel.*
5. Click the **Done button**.  
*The Add Devices window closes.*

### *Configure OMNEO Keypanels using IPedit*

To **configure OMNEO keypanels using IPedit**, do the following:

*Using the Device Configuration Section:*

1. In the Description field, enter a **description for the keypanel**, if desired.

*Using the Channel Configuration Section:*

2. In the Channel Description field, enter a **channel description**, if applicable.
3. From the Destination Type drop down menu, select **ODIN**.

**NOTE:** The Destination Type does not need to be selected if using the Browse window to select the device. It fills the type and IP Address automatically.

4. In the Destination Device Name field, enter the **name of the device** to which the channel will connect.

OR

Click the ... button.

*The Discovered Devices Window appears.*

- a. Expand the **tree** to view the destination devices available.
  - b. From the expanded tree, select the **device** to connect to this keypanel.
  - c. Click **OK**.
5. From the Destination Channel drop down menu, select the **channel** to which the keypanel will connect.

**NOTE:** If present, the Enable AIO check box must be cleared in order for the keypanel to connect via OMNEO. If this option is selected, the keypanel will connect via AIO and the OMNEO link will become an AUX Input/Output.

6. Send the **changes** to the keypanel.

### *Configure RVON Keypanels using IPedit*

To **configure RVON keypanels using IPedit**, do the following:

*Using the Device Configuration Section:*

1. In the Description field, enter a **description for the keypanel**, if desired.

*Using the Channel Configuration Section:*

2. In the Channel Description field, enter a **channel description**, if applicable.
3. From the Destination Type drop down menu, select **ODIN-R**.

**NOTE:** The Destination Type does not need to be selected if using the Browse window to select the device. It fills the type and IP Address automatically.

4. From the Destination Channel drop down menu, select the **channel** to which ODIN connects.
5. From the Coding Algorithm drop down menu, select the **appropriate codec**.
6. From Audio/Packet drop down menu, select the **audio packet size**.
7. (Optional) Select the **VAD check box**, if applicable.

**NOTE:** If present, the Enable AIO check box must be cleared in order for the keypanel to connect via RVON. If this option is selected, the keypanel will connect via AIO and the RVON link will become an AUX Input/Output.

8. Send the **changes** to the keypanel.

### Map Multiple Frames in the System (Multi-Frame Only)

Frame Mapping can be done from the front panel of ODIN or by using the AZedit configuration software.

- To map frames from the front panel, see “Frame Mapping (Front Panel)” on page 48.
- To map frames from AZedit, see “Frame Mapping (AZedit)” on page 49.

### IFL Inter-Frame Linking (Multi-Frame Only)

---

**IMPORTANT:** IFL connection redundancy does not mean the frame and its setup is redundant. Only the connection between frames is protected from cable failure.

---

### Cabling ODIN for IFL

- To cable IFL between two ODIN frames, see “Cabling IFL Between Two ODIN Frames” on page 42.
- To cable IFL between three or more ODIN frames, see “Cabling IFL Between Three Or More ODIN Frames” on page 43.
- To check IFL status from the front panel, see “Checking the IFL Status (Front Panel)” on page 46.
- To check IFL status from AZedit, see “Checking the IFL Status (AZedit)” on page 47.

## Rack Mounting Instructions

**CAUTION:** Ensure the frame is securely mounted to avoid uneven mechanical loading. Use all fasteners, as defined in the installation instructions.

### Rack Mounting (without Optional Rear Supports)

To mount ODIN in a rack, do the following:

- > Using four rack screws (not supplied), secure ODIN into the rack.









### Rack Mounting (with Optional Rear Supports)

#### Rear Rack Mounting Components

**IMPORTANT:** The rear support brackets are an optional piece of equipment. It is recommended to use these support brackets in high vibration environments, such as trucks.

TABLE 2. Mounting Components

	Component Descriptions
	8 - Pan head screw M3 x 6mm
	8 - Flat-head screw M3 x 6mm
	8 - Internal tool lock washer M3
	8 - Flat washer 3.2mm ID x 7mm OD x 0.5mm thick
	2 - Matrix side brackets
	2 - Rear side brackets

To mount an ODIN frame in a rack using the optional rear brackets, do the following:

**IMPORTANT:** Do not over-tighten the fasteners. Over-tightening can result in stripped or broken screws.

- Using the supplied flat-head screws (four on each side), secure the **matrix side brackets** to each side of the ODIN frame.

**NOTE:** Take care to verify the guide pins on the side brackets face inward.

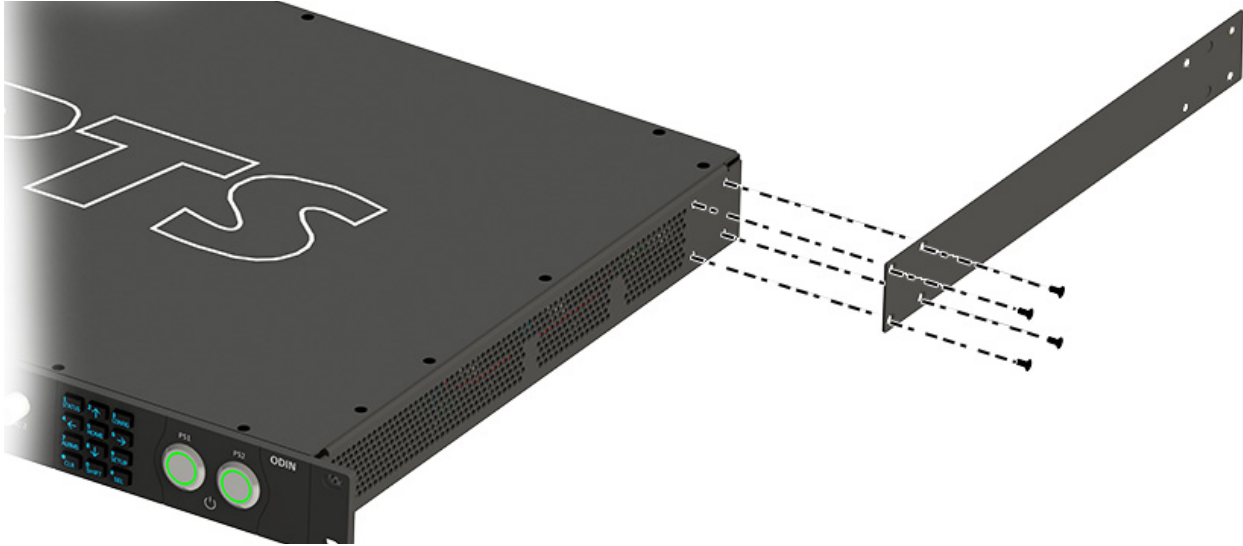

**IMPORTANT:** Alternately, attaching the rear side brackets before putting the ODIN frame in the rack is possible. The frame may need to be slightly tilted for the rear side bracket to clear the back of the rack before securing it to the rack.

The screws that attach the rear side bracket to the matrix side brackets should be slightly loosened to allow for the bracket to slide smoothly into position. Once in position, the screws can be tightened to keep the bracket in place.

- Using four rack screws (not supplied), secure the **frame** into the rack.



3. On both sides, pass the rear side brackets through the keyhole stand-off (1).

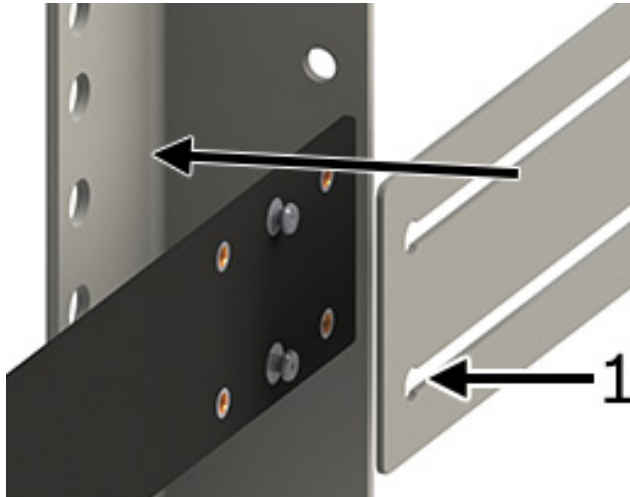

4. Slide the rear side brackets until they reach the rear rack posts.

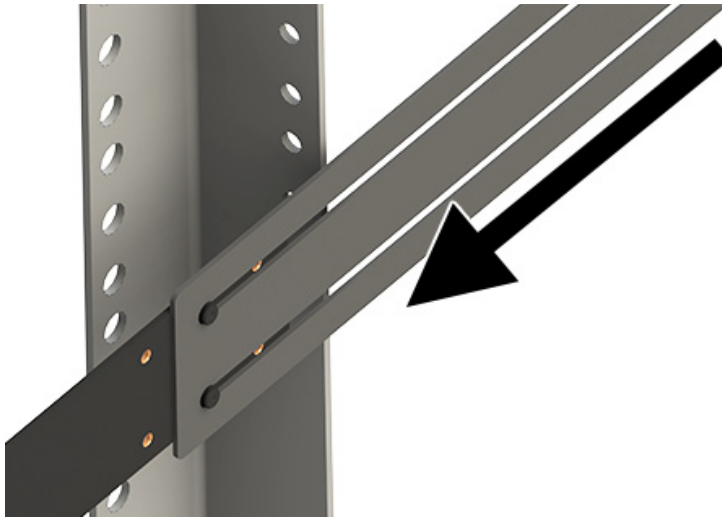

5. Using four rack screws (not supplied), secure the rear side brackets to the rear rack posts.



6. Using the supplied pan head screws, internal tooth washers and flat washers, secure the rear side brackets to the matrix side brackets.

**IMPORTANT:** Layer the screw, the tooth lock washer and the flat washer in this order to attach the rear side bracket to the matrix side bracket.

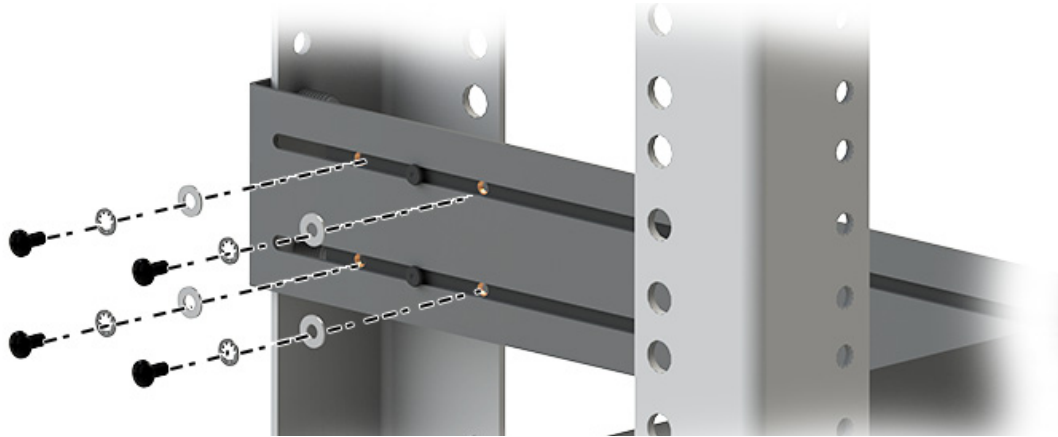

### *GPIO 24-Position Terminal Block Connector*

The **GPIO 24-Position Terminal Block Connector** is used to provide connections to relays (outputs) and opto-isolators (inputs). Using the table, “GPIO Connector: J10” on page 20, connect the correct wires to the 24-position connector.

#### **Wire Specifications**

*Solid Wire: 26-16AWG/0.13–1.5MM<sup>2</sup>*

*Stranded Wire: 26-16AWG/0.13–1.5MM<sup>2</sup>*

To connect the 24-position terminal block to the frame, do the following:

1. Align the **terminal block connector** with the **24-position connector** on the rear side of the frame.
2. Gently push the **connector** into place.  
*The locking levers should lock into place.*

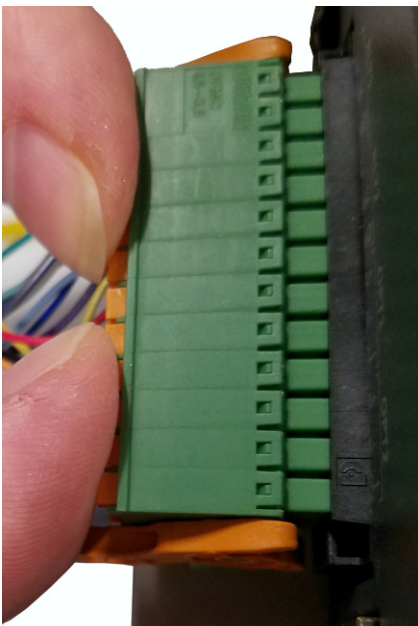



To detach the 24-position terminal block connector from the frame, do the following:

- > Using both thumbs, gently **press down on the locking levers**.  
*The connector is released from the frame.*

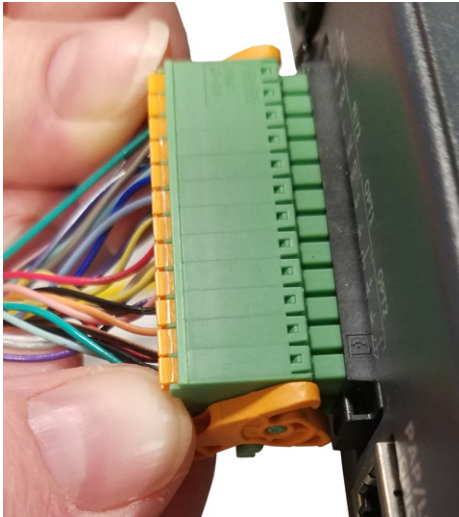

## *Fan Tray*



FIGURE 9. Fan Tray Side Panel of ODIN

To replace the fan tray, do the following:

1. Remove all **power** from the frame.
2. Remove the frame from **rack**, if rack-mounted.
3. Remove the **eight screws** holding the fan tray in place.

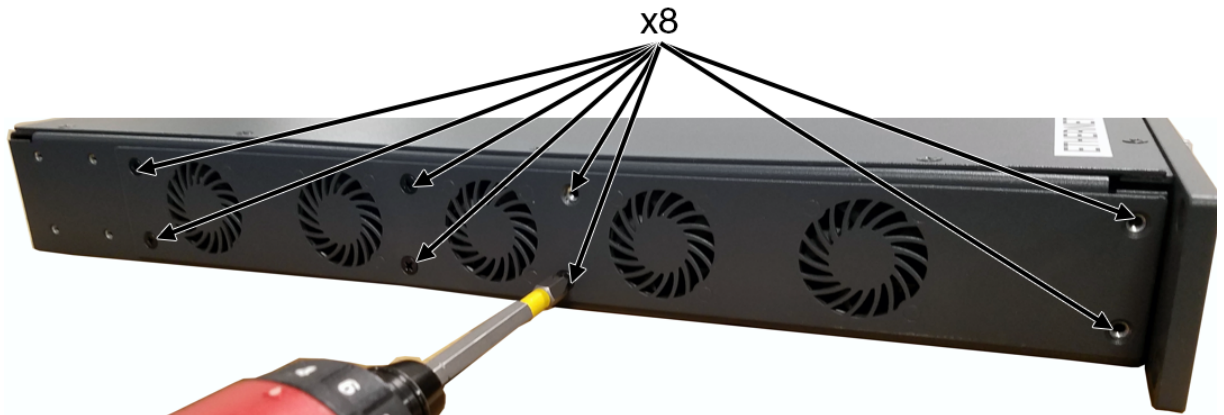

**NOTE:** M3x6 flat-head screws are used.

- Carefully, slide the **fan tray** away from the frame and then lay the external face on a flat smooth surface.

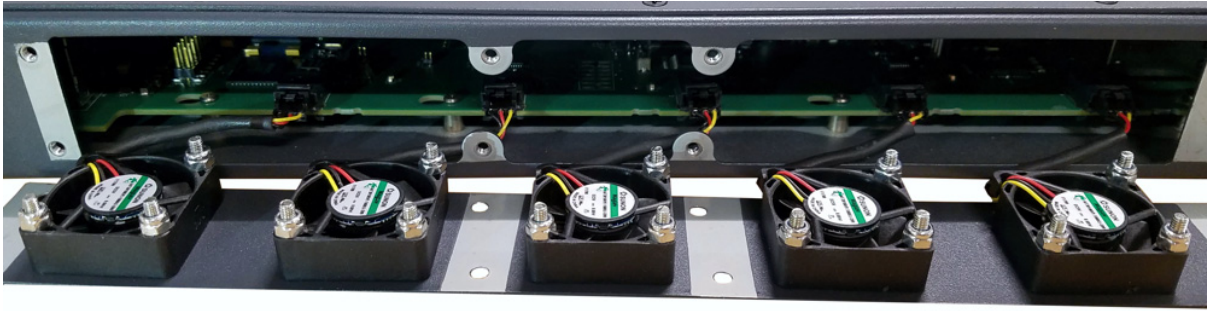

- Unplug the **five fan harnesses** from the frame.

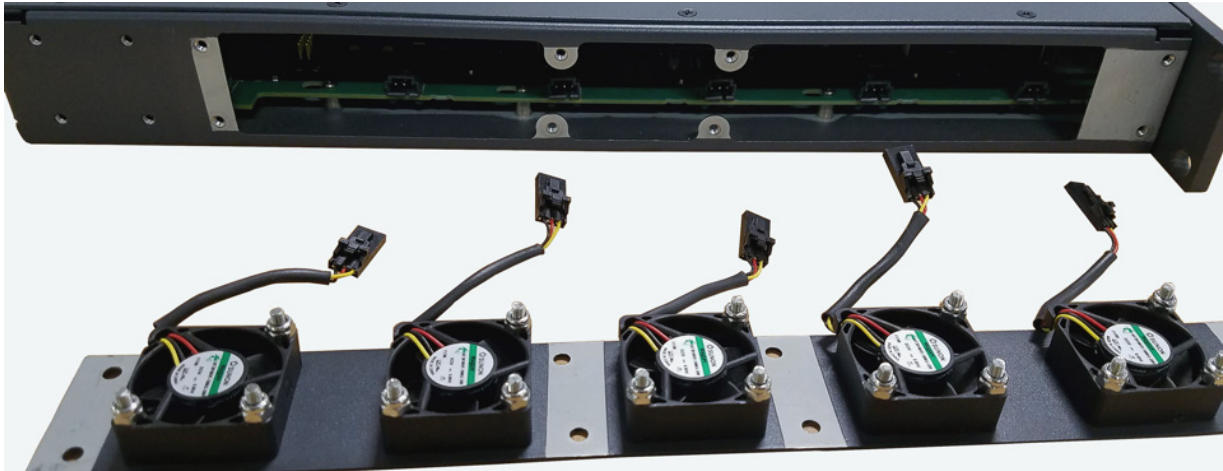

**IMPORTANT:** Care must be taken to depress the locking feature (1) on each harness connector before disengaging. Wire and/or receptacle damage can occur if not properly removed.

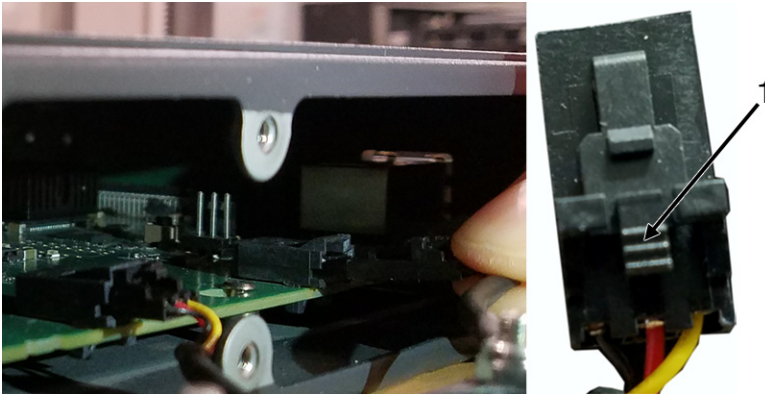

- Replace the **fan tray**, staging it in the same position as the previous fan tray.
- Reattach the **five harness connectors**.

**NOTE:** Lightly tug each harness connector to ensure it is properly seated.

- Slide the **new fan tray assembly into the frame**.

**IMPORTANT:** Take care that all wires are inside the frame.

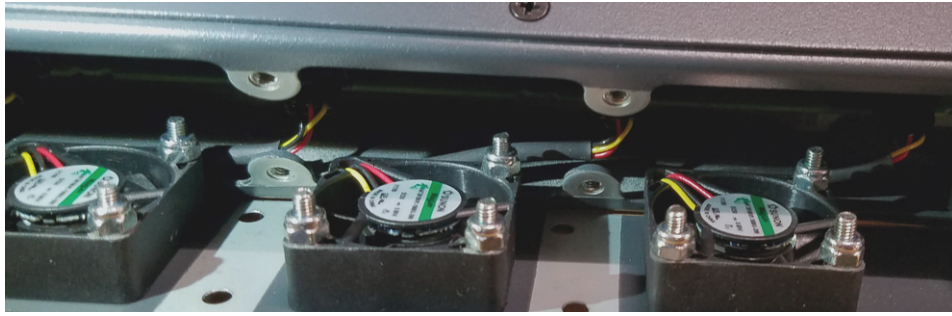

- Replace the **eight screws**, securing the fan tray to the frame.

**NOTE:** M3x6 flat-head screws are used

- Before mounting the unit back into the rack, **power on the unit** to verify the fans are working properly.
- From the Home screen, navigate to the **Cooling Fans screen** (Status | Hardware | Cooling Fans) to monitor the status of the fan bank.



---

## *Download Firmware*

There are two processes for updating firmware and resources on ODIN; via AZedit or via the **FWUT** (Firmware Upload Tool). However, updating the Audio FPGA can only be done using the FWUT.

### Download Firmware Using AZedit

To **download firmware to ODIN**, do the following:

1. Open **AZedit**.
2. From the Status menu, select **Software Versions | Master Controllers**.  
*The Master Controller Version Information window appears.*
3. Highlight the **ODIN** to be updated.

**NOTE:** More than one selection may be made holding the CTRL key down while selecting multiple frames.

4. Right-click the **highlighted selections**.  
*A popup menu appears.*

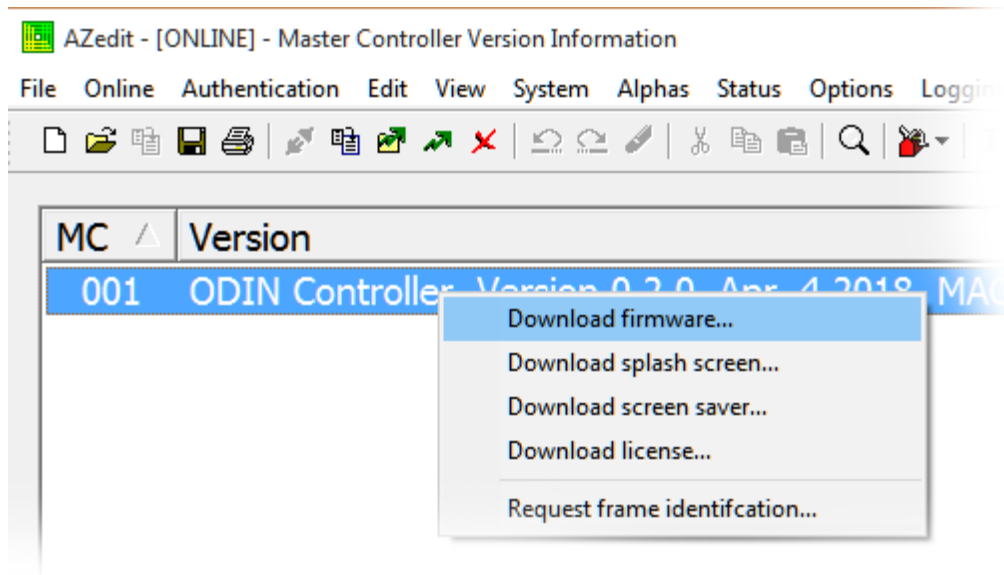

5. Select **Download firmware....**  
*The Firmware Download window appears.*
6. Using the browse button, browse to the **desired file**.

7. Click **Open**.

The *Download Device Firmware* window appears.

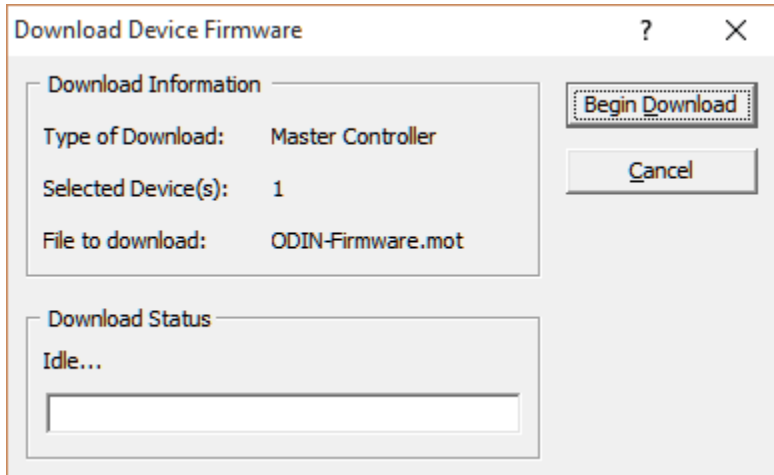
8. Click **Begin Download**.

The download begins.

Once the image loads, a success message appears.

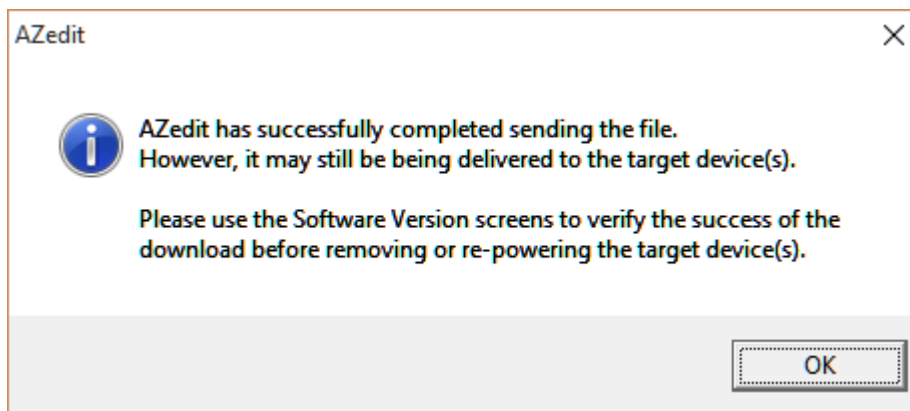
9. Click **OK**.10. In the Master Controller Version Information window, verify the **firmware upgrade**.

The flash programming progression status is shown on the front panel of the ODIN frame.

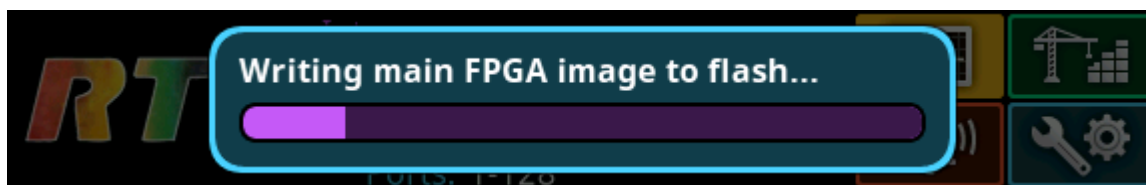

**NOTE:** ODIN-Firmware.mot file contains six different components—Main firmware, main FPGA, LEC firmware, FP firmware, FP FPGA, and Bootloader—that programs each one after the other. Multiple progression bars are seen.

## Download Firmware Using the Firmware Upload Tool

The Audio FPGA can only be upgraded using the Firmware Upload Tool.

**NOTE:** The ODIN-Firmware.capfw file includes all the components contained in the .mot file, plus the Audio FPGA.

Required Firmware version:

*FWUT* *V5.4.0 and above*

To **download firmware to ODIN**, do the following:

1. Open the **Firmware Upload Tool**.
2. From the File menu, select **Options**.  
*The Firmware Upload Tool Options window appears.*

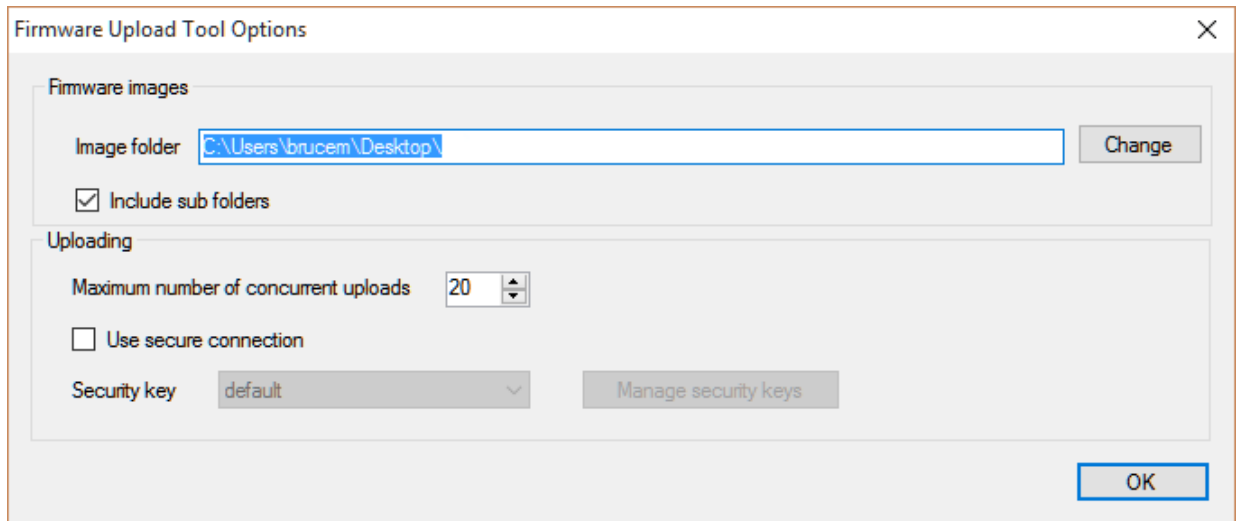

3. Click the **Change button**.  
*The folder network window appears.*
4. Navigate to the **folder** where the firmware resides.
5. Click **OK**.
6. Click **OK**, again.  
*The Firmware Upload Tool Options window closes.*
7. From the ODIN Device page, select the **device** to update.

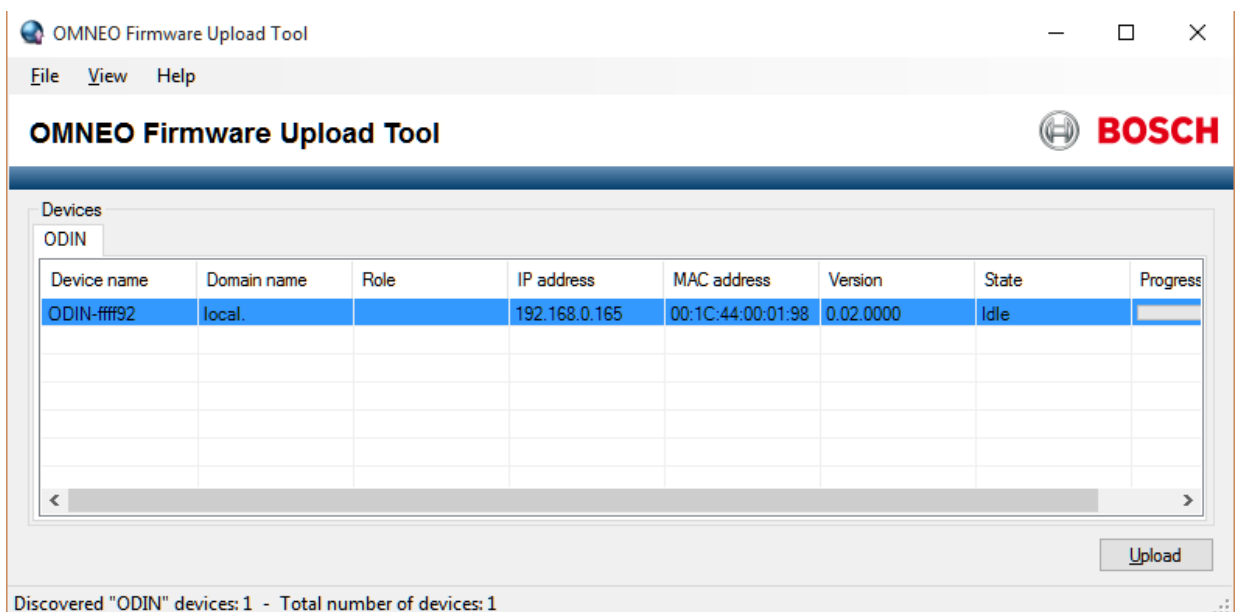

8. Click the **Upload button**.  
*The Select Firmware for Upload window appears.*
9. From the list of firmware, select the **firmware** to download.

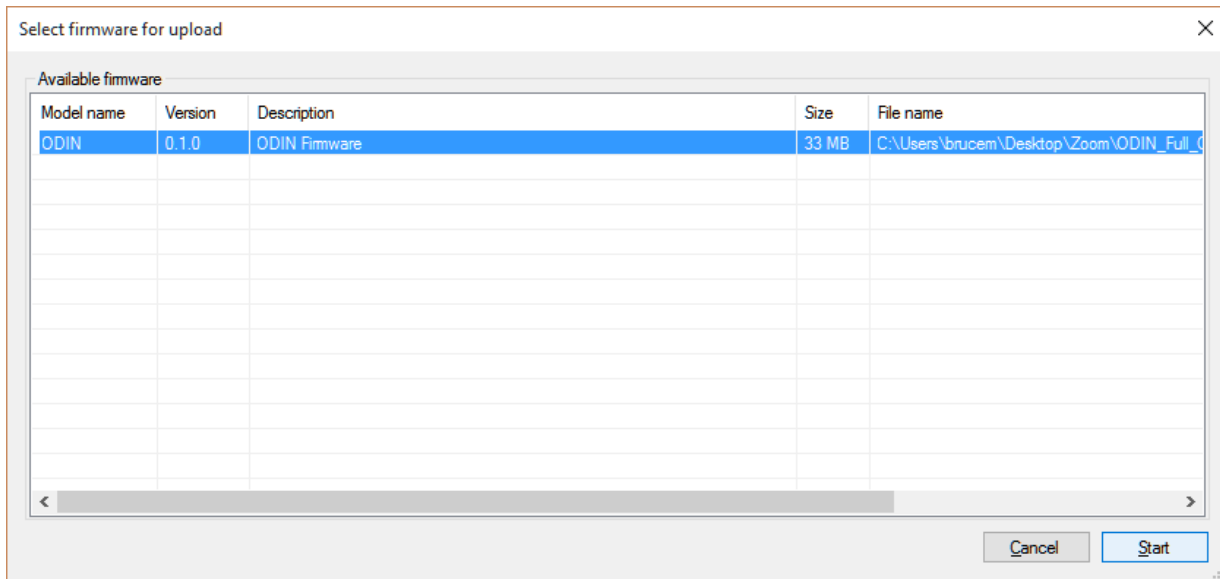

10. Click the **Start button**.  
*The Firmware Upload Tool main screen appears with a progression bar displayed.*

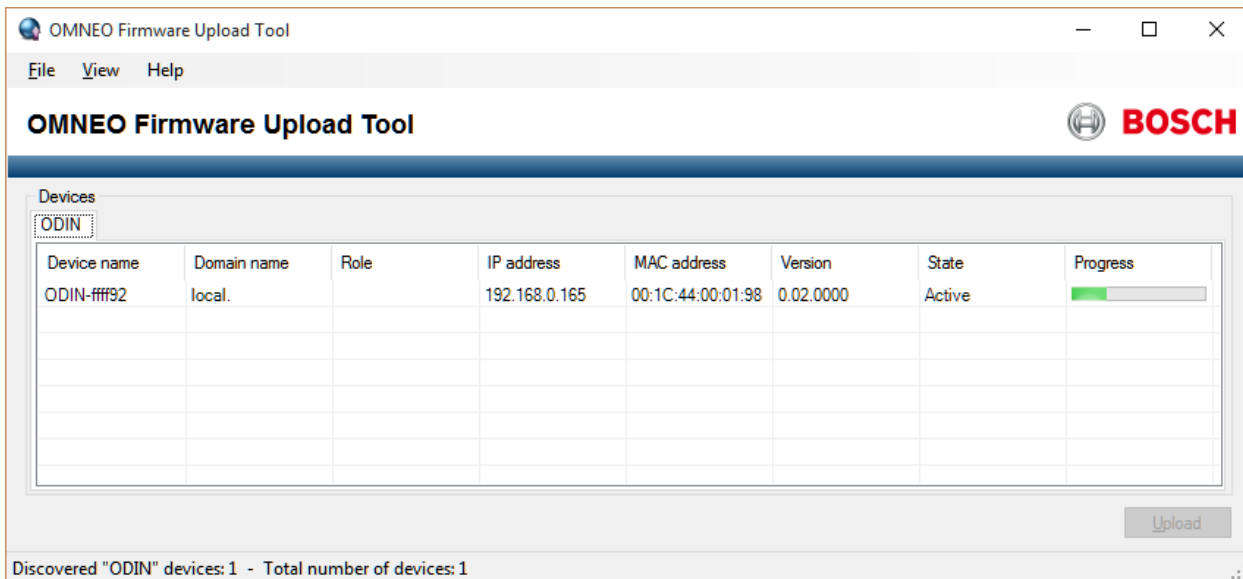

11. Once the Audio FPGA is downloaded, ODIN **reboots and switches into bootloader mode automatically**.

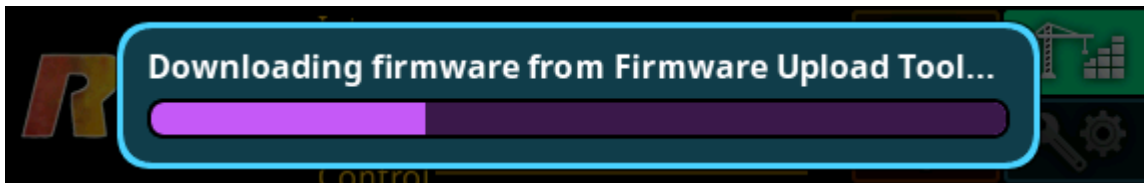

12. In bootloader mode, the **remaining firmware components are downloaded**.
13. Once finished downloading the remaining firmware, ODIN **reboots automatically**.



---

## Download a Splash Screen, Screen Saver or Licenses

**NOTE:** When using a splash screen or screen saver the maximum bitmap size is 576 x 90. If the bitmap is smaller than the full screen dimensions, the front panel centers the bitmap horizontally and vertically on the display and fills the background with the same color as the pixel in the top left corner of the splash screen.

Supported file types: .bmp, .gif, .jpg, .png, and .tif.

---

**IMPORTANT:** When a license file is downloaded, all OMNEO connections are lost for approximately 20 seconds and then re-established.

---

1. Open **AZedit**.
2. From the Status menu, select **Software Versions | Master Controllers**.  
*The Master Controller Version Information window appears.*
3. Highlight the **Master Controller** to be updated.

**NOTE:** More than one selection may be made holding the CTRL key down while selecting multiple frames.

4. Right-click the **highlighted selection(s)**.  
*A popup menu appears.*

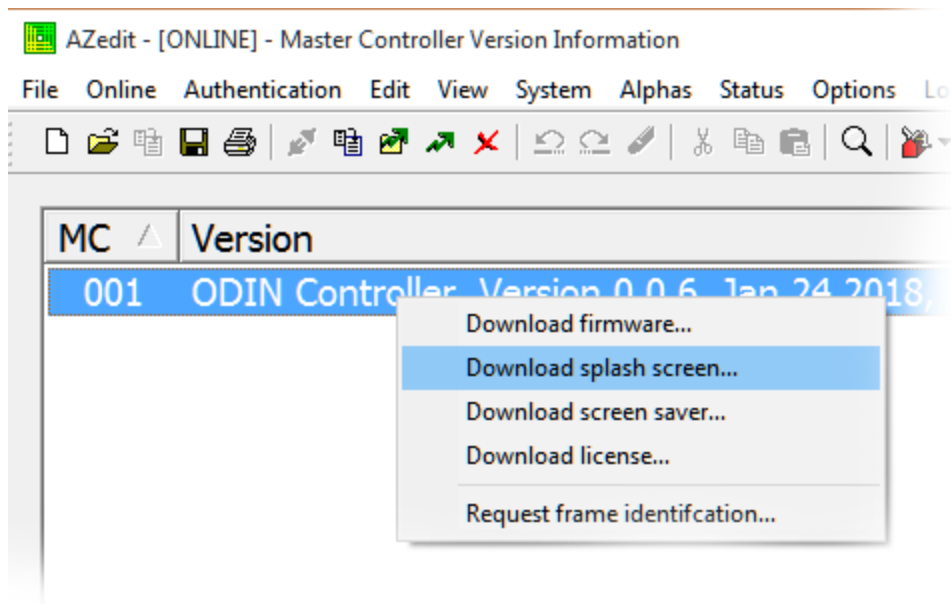

5. Select **Download splash screen...**, **Download screen saver...**, or **Download license...**.  
*A network folder window appears.*
6. Navigate to the desired **file**.
7. Click **Open**.  
*The Download File window appears.*

8. Click **Begin Download**.

The download begins. A progress bar appears to show the progress of the download. Once complete, a success message appears.

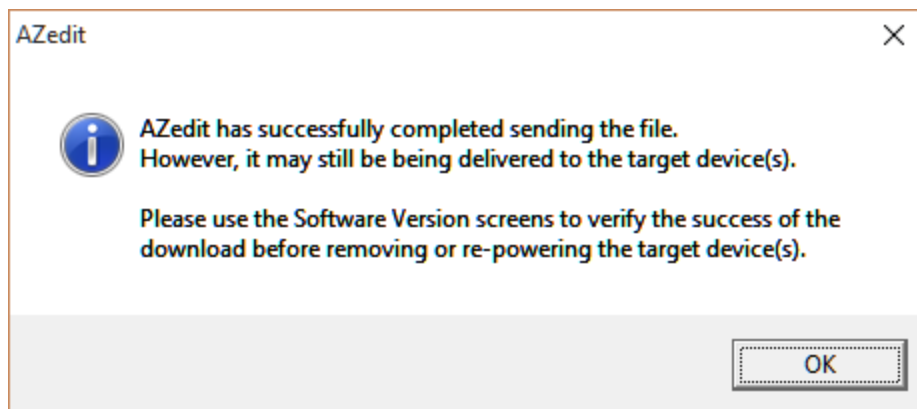
9. Click **OK**.

The message closes. The file is updated.

## Request Frame Identification

The **Request Frame Identification** option is used to display the frame number on the front panel of the frame from AZedit. The display is more visible to see, for example from across a room.

To have each **ODIN** frame in an intercom identify itself by displaying the frame number on the front panel, do the following:

1. Open **AZedit**.
2. From the Status menu, select **Software Versions | Master Controllers**.  
*The Master Controller Version Information window appears.*
3. Highlight the **Master Controller** to be updated.

**NOTE:** More than one selection may be made holding the CTRL key down while selecting multiple frames.

4. Right-click the **highlighted selection(s)**.  
*A popup menu appears.*

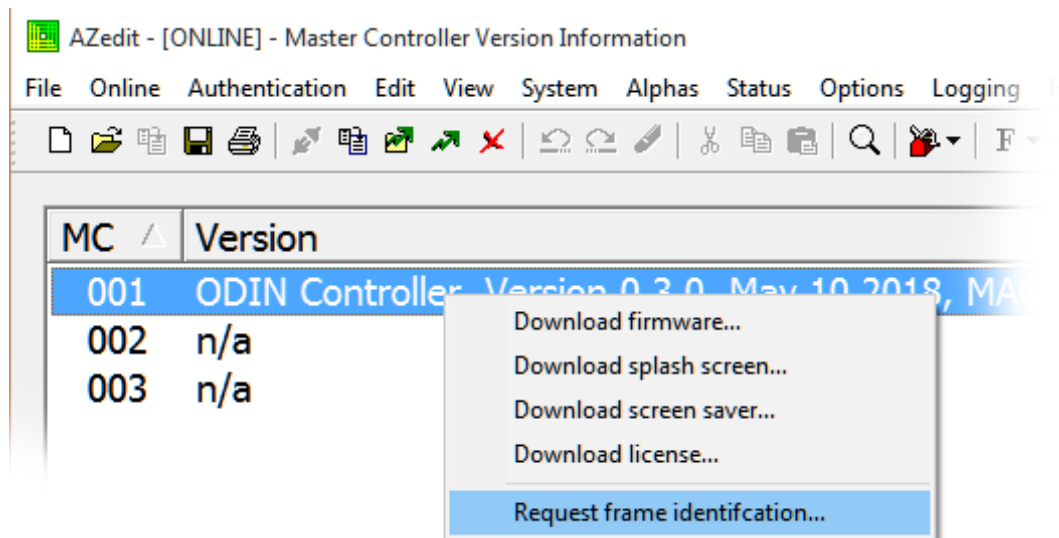

- From the popup menu, select **Request frame identification....**  
*All ODIN frames in the intercom display their frame number on the front panel.*



**NOTE:** A green popup appears on the frame which is connected to AZedit. On the other frames in the intercom, the popup is blue.



# Menu System Description

**NOTE:** A menu system quick reference chart is located at “Navigating the Menu” on page 19.

## Main Menu Access

The **Home Screen** is the top-most level of the menu structure.

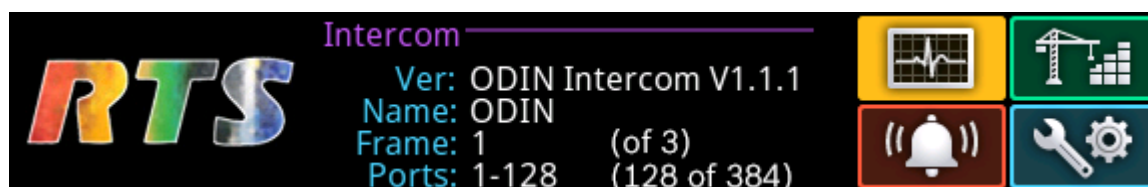

**FIGURE 10.** ODIN Home

Available selections for this menu are:

*Status*  
*Configuration*  
*Intercom Setup*  
*Alarms*

To **access the main menu structure**, do the following:

1. Rotating the right encoder knob, navigate to the desired menu – **Status, Configure, Intercom Setup, or Alarms.**
2. Press the **right encoder knob** to access the selected menu.

**NOTE:** For detailed instructions on using the front panel controls, see “Navigating the Menu” on page 19 and “Editing Form Data” on page 20.

**IMPORTANT:** This note applies to many screens in the ODIN menu structure.

If the intercom system contains only one ODIN frame, the Frame field is hidden.

If the intercom system contains multiple ODIN frames, the Frame field is visible allowing the frame to be switched to alternate frames. While the Frame field is highlighted, press the **right encoder knob** to activate the field. Once activated, turn the right encoder knob to scroll through available frames, and then press the right encoder knob a second time to select the specified frame.

## Status Menu



FIGURE 11. Status Menu Icons

The **Status** menu is used to view status information related to the following areas:

*System*

*Network*

*Ports*

*Peripherals*

*Intercom*

*Hardware*

## System Menu

The **System** menu contains information about the firmware used in ODIN, AZedit, and IPedit sessions currently running.



FIGURE 12. Status | System Menu Items

## ODIN Versions

The **ODIN Versions** screen displays the current versions for each firmware component in the system.

Status: System: ODIN Versions	
Main Application:	1.1.0
RVON Application:	1.1.0
Bootloader:	1.0.3
Main FPGA:	3.0.0
Audio FPGA:	5.40.5418
FP Application:	1.1.0
FP FPGA:	0.3.0

FIGURE 13. Status | System | ODIN Versions

**NOTE:** If RVON is not supported on the ODIN, then **LEC** (Line Echo Cancellation) Application displays.

## AZedit Sessions

The **AZedit Sessions** screen displays the user name (login name), if applicable, and network connection (CTRL or MGMT Port) of each AZedit session connected to the frame.

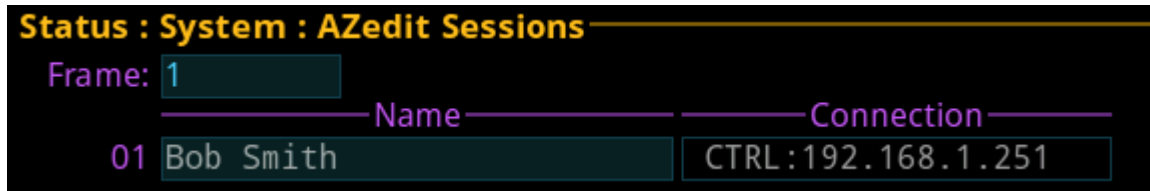

FIGURE 14. Status | System | AZedit Sessions

### **Frame Field**

The **Frame** field is used to select the frame to be viewed.

### **Name Field**

The **Name** field displays the authenticated user name of the user connected. A login name is only required if authentication is enabled.

### **Connection Field**

The **Connection** field displays the IP address of the computer running AZedit and whether the session is communicating on the Control Port or on the Management Port.

## IPedit Sessions

The **IPedit Sessions** screen displays the user name (login name) and network connection (OMNEO or RVON Interface Port) of each IPedit session connected to the frame.

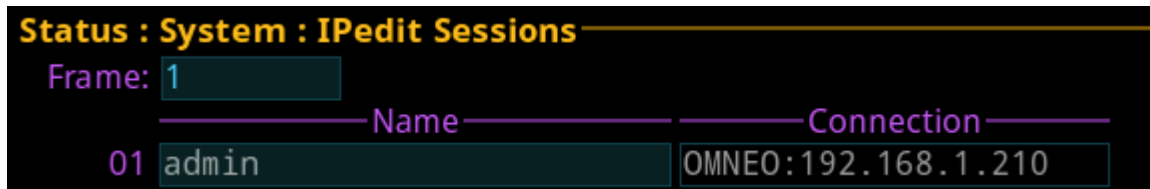

FIGURE 15. Status | System | IPedit Sessions

### **Frame Field**

The **Frame** field is used to select the frame to be viewed.

### **Name Field**

The **Name** field displays the authenticated user name of the user connected.

### **Connection Field**

The **Connection** field displays the IP address of the computer running IPedit and displays whether the session is communicating on the OMNEO or RVON Port.

## Network Menu

The **Network** menu item is used to view information about the following network connections:

*Control Port*

*OMNEO (SFP)*

*OMNEO (RJ-45)*

*RVON*

*Management Port*

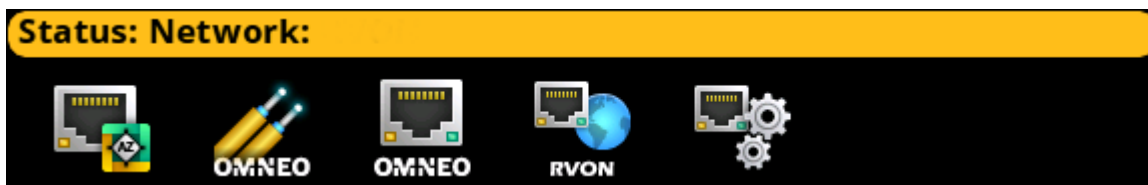

FIGURE 16. Status | Network Menu Icons

## Control Port

The **Control Port** screen is used to view the control port network status information. The Control Port is the physical interface for the computer running AZedit. The control port is also the physical interface for communications to a Trunk Master.

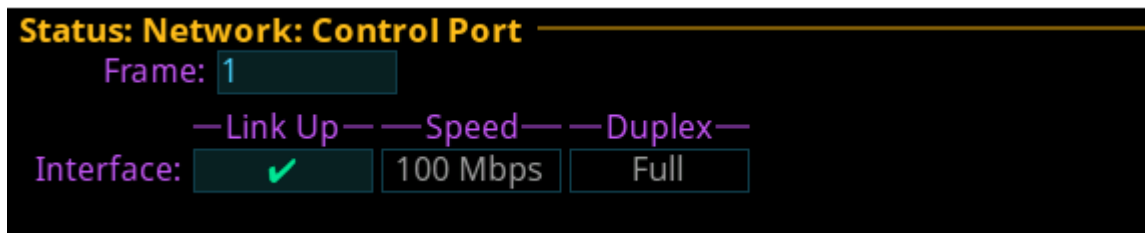

FIGURE 17. Status | Network | Control Port



### Frame Field

The **Frame** field, if visible, displays the frame currently being viewed.

### Link Up Field

The **Link Up** field displays the status of data communication on the port.

Available statuses are:

	The Ethernet link is up
	The port is configured (has an IP address) but the link is not up
	The control port is not configured (has no IP address)



## Speed Field

The **Speed** field displays the transmission speed of the Control Port interface.

There are three speeds the Ethernet links support: *10 Mbps*, *100 Mbps*, or *1 Gbps*.

## Duplex Field

The **Duplex** field displays the transmit mode the network connection is currently operating – Half or Full Duplex. Almost all Ethernet interfaces auto-negotiate to Full Duplex. If the interface displays Half Duplex mode, this typically signifies the auto-negotiate failed, resulting in network collisions and errors.

Available options for this field are

*Half-Duplex* – can either transmit or receive, but not both simultaneously.

*Full-Duplex* – can transmit and receive simultaneously.

## OMNEO (SFP)

The **OMNEO (SFP)** screen is used to view the OMNEO (SFP) network status.

**Status : Network : OMNEO (SFP)**

Frame: 1

Interface	Primary	Secondary
Link Up:	✓	✓
Speed:	1 Gbps	1 Gbps
Duplex:	Full	Full
SFP Installed:	✓	✓
SFP Tx Fault:	-	-
Tx Power:	0.280 mW	0.286 mW
SFP Installed:	✓	✓
SFP Tx Fault:	-	-
Tx Power:	0.283 mW	0.283 mW
Rx Power:	0.366 mW	0.171 mW

FIGURE 18. Status | Network | OMNEO (SFP)

## Frame Field

The **Frame** field (if visible) displays the frame currently being viewed.

## Primary Column

The **Primary** column displays the status for the primary OMNEO (SFP) fiber connection.



## Secondary Column

The **Secondary** column displays the status for the secondary OMNEO (SFP) fiber connection.

### Link Up Field

The **Link Up** field displays status of the fiber link.

Available statuses are:

	The fiber module is installed and the link is connected.
	The fiber module is installed, but the link is not connected.
	The fiber module is not installed.

### Speed Field

The **Speed** field displays the transmission speed over the OMNEO interface.

The OMNEO interfaces support *100 Mbps and 1 Gbps*.

### Duplex Field

The **Duplex** field displays the transmit mode the OMNEO network interface is currently operating – Half or Full Duplex. Almost all Ethernet interfaces auto-negotiate to Full Duplex. If the interface displays Half Duplex mode, this typically signifies the auto-negotiate failed, resulting in network collisions and errors.

Available options for this field are

*Half-Duplex* – can either transmit or receive, but not both simultaneously.



*Full-Duplex* – can transmit and receive simultaneously.

### SFP Installed Field

The **SFP Installed** field displays whether or not the transceiver module is installed on ODIN. This field is directly tied to the Link Up field. If a transceiver module is not installed the OMNEO (SFP) port cannot be used.

### SFP Tx Fault Field

The **SFP Tx Fault** field displays if a fault has occurred.

	An error has occurred. While this field is highlighted, press the SEL button to display a fault description.
	No errors detected.

### Tx Power Field

The **Tx Power** field displays the amount of power used to transmit the outgoing fiber signal.

### Rx Power field

The **Rx Power** field displays the amount of power being received from the incoming fiber signal.

## OMNEO (RJ-45)

The **OMNEO (RJ-45)** screen is used to view the status of the OMNEO (RJ-45) network status.

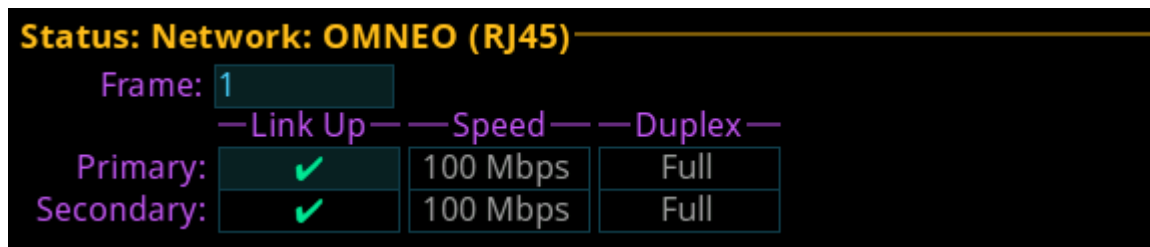

FIGURE 19. Status | Network | OMNEO (RJ-45)

### Frame Field

The **Frame** field is used to select the frame to be viewed.

### Primary Row

The **Primary** row displays the link status, connection speed and duplex status for the primary OMNEO (RJ-45) connection.



### Secondary Row

The **Secondary** row displays the link status, connection speed and duplex status for the secondary OMNEO (RJ-45) connection.

### Link Up Field

The **Link Up** field displays the status of data communication on the OMNEO (RJ-45) port.

Available statuses are:

	The link is up.
	The link is not up, but an IP address is defined.
	No IP address is defined.

### Speed Field

The **Speed** field displays the transmission speed over the OMNEO interface.

The Ethernet links support *100 Mbps* or *1 Gbps*.

### Duplex Field

The **Duplex** field displays the transmit mode the OMNEO network connection is currently operating – Half or Full Duplex. Almost all Ethernet interfaces auto-negotiate to Full Duplex. If the interface displays Half Duplex mode, this typically signifies the auto-negotiate failed, resulting in network collisions and errors.

Available options for this field are:

*Half-Duplex* – can either transmit or receive, but not both simultaneously.

*Full-Duplex* – can transmit and receive simultaneously.

## RVON

The **RVON** screen is used to view the status of the RVON network status.

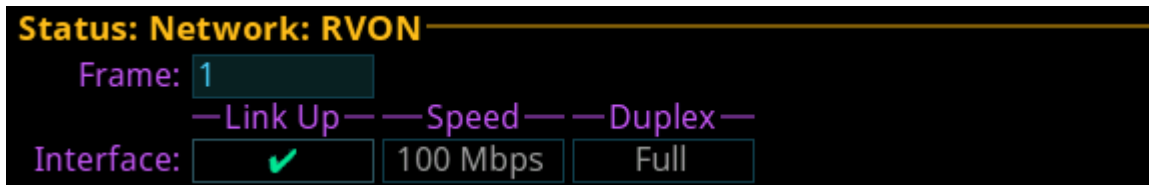

FIGURE 20. Status | Network | RVON



### Frame Field

The **Frame** field is used to select the frame to be viewed.

### Link Up Field

The **Link Up** field displays the status of data communication on the RVON port.

Available statuses are:

	The link is up.
	The link is not up, but an IP address is defined.
	No IP address is defined.

### Speed Field

The **Speed** field displays the transmission speed over the RVON port.

The Ethernet links supports *100 Mbps* or *1 Gbps*.

### Duplex Field

The **Duplex** field displays the transmit mode the RVON network connection is currently operating – Half or Full Duplex. Almost all Ethernet interfaces auto-negotiate to Full Duplex. If the interface displays Half Duplex mode, this typically signifies the auto-negotiate failed, resulting in network collisions and errors.

Available options for this field are:

*Half-Duplex* – can either transmit or receive, but not both simultaneously.

*Full-Duplex* – can transmit and receive simultaneously.

## Management Port

The **Management Port** screen displays the network status information for the Management Port.

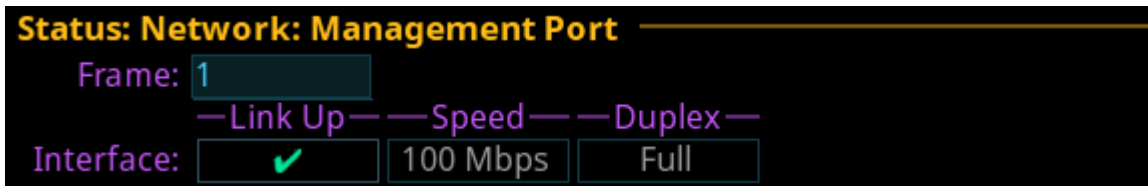

FIGURE 21. Status | Network | Management Port



### Frame Field

The **Frame** field is used to select the frame to be viewed.

### Link Up Field

The **Link Up** field displays the status of the links on the port.

Any of the following indications may appear:

	The link is up.
	The link is not up, but the IP address is defined.
	No IP address is defined.

### Speed Field

The **Speed** field displays the transmission speed over the Management Port interface.

The speeds the Ethernet links support: *10 Mbps, 100 Mbps or 1 Gbps.*

### Duplex Field

The **Duplex** field displays the current transmit mode – Half or Full Duplex. Almost all Ethernet interfaces auto-negotiate to Full Duplex. If the interface displays Half Duplex mode, this typically signifies the auto-negotiate failed, resulting in network collisions and errors.

Available options for this field are

*Half-Duplex* – can either transmit or receive, but not both simultaneously.

*Full-Duplex* – can transmit and receive simultaneously.

## Ports

The **Ports** menu is used to view port status for the following port and device types:

*OMNEO*  
*RVON*  
*AIO*  
*2-Wire*  
*Keypanel*  
*TIF*

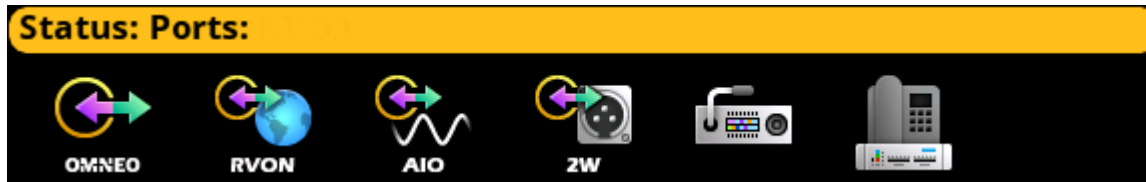

FIGURE 22. Status | Ports Menu Icons

## OMNEO

The **OMNEO** screen displays the status for OMNEO ports.

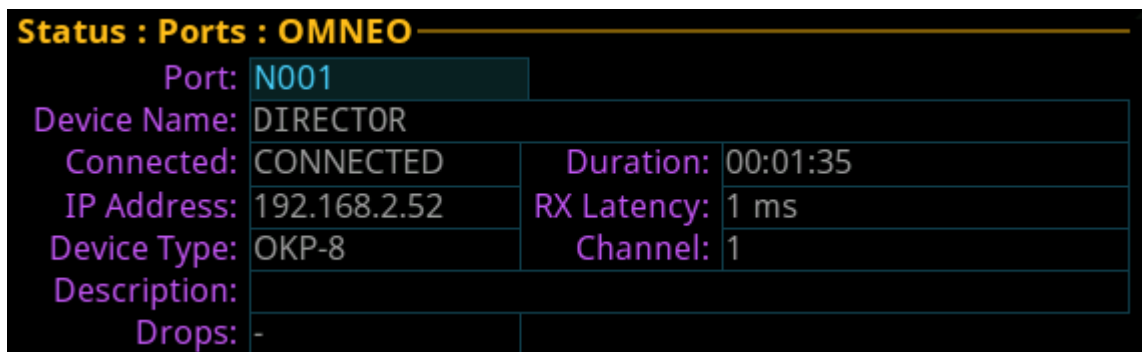

FIGURE 23. Status | Ports | OMNEO

### Frame Field

The **Frame** field is used to select the frame to be viewed.

### Port Field

The **Port** field displays the port alpha for the OMNEO port.

### Device Name Field

The **Device Name** field displays the name of the device to which this port is configured to connect.

**NOTE:** If this is an OMNEO connection, the device name always populates the field, unless the device connected to the port is a third party Dante device.

## Connected Field

The **Connected** field is used to view the state of the connection. Typical states are Idle and Connected, however there can be transitional states during connection setup and tear down.

The connection states available are *Connected* and *Idle*.

## Duration Field

The **Duration** field is used to view the duration of the connection.

This field is shown in *days* and *hh:mm:ss* (for example, 3 days 02:32:23).

## IP Address Field

The **IP Address** field displays the IP address of the OMNEO device to which this port is connected.

## Rx Latency Field

The **Rx Latency** field displays the latency of receive audio for this connection.

## Device Type Field

The **Device Type** field displays the type of OMNEO device connected to the port.

## Channel Field

The **Channel** field displays the channel number on the device to which this port is connected.

## Description Field

The **Description** field displays the description of the channel.

## Drops Field

The **Drops** Field displays the number of times a connection has been disconnected.

## RVON

The **RVON** screen displays the status for RVON ports.

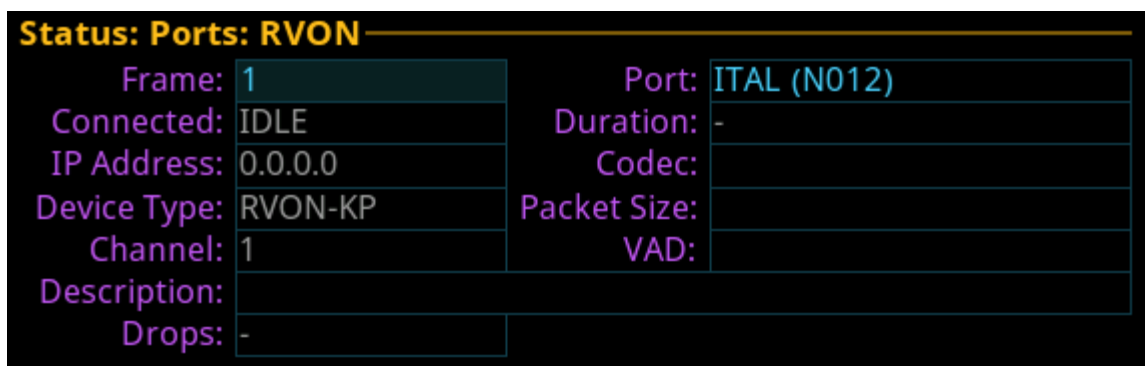

Status: Ports: RVON			
Frame:	1	Port:	ITAL (N012)
Connected:	IDLE	Duration:	-
IP Address:	0.0.0.0	Codec:	
Device Type:	RVON-KP	Packet Size:	
Channel:	1	VAD:	
Description:			
Drops:	-		

FIGURE 24. Status | Ports | RVON

## Frame Field

The **Frame** field is used to select the frame to be viewed.

## Port Field

The **Port** field displays the port alpha for the RVON port.

**Connected Field**

The **Connected** field is used to view the state of the connection. Typical states are Idle and Connected, however there can be transitional states during connection setup and tear down.

The connection states available are *Connected* and *Idle*.

**Duration Field**

The **Duration** field is used to view the duration of the connection.

This field is shown in *days* and *hh:mm:ss* (for example, 3 days 02:32:23).

**IP Address Field**

The **IP Address** field displays the IP address of the RVON device to which this port is connected.

**Codec Field**

The **Codec** field displays the codec type configured for the RVON port

**Device Type Field**

The **Device Type** field displays the type of RVON device connected to the port.

**Packet Size Field**

The **Packet Size** field displays the size of each audio packet. The packet size determines how much audio is carried across the network in each transmitted packet.

**Channel Field**

The **Channel** field displays the channel number on the device to which this port is connected.

**VAD Field**

The **VAD** field displays the threshold at which point audio is transmitted across the network.

**Description Field**

The **Description** field displays the description of the channel.

**Drops Field**

The **Drops** field displays the number of times a connection has been disconnected.



## AIO

The **AIO** screen is used to display the AIO port status, which includes keypanel status and communication error counters.

**Status : Ports : AIO**

Frame:

AIO	Port	Status	Errors To / From	BER To / From
01	N001	✓	- / -	- / -
02	N002	-	- / -	- / -
03	N003	-	- / -	- / -
04	N004	-	- / -	- / -
05	N005	-	- / -	- / -
06	N006	-	- / -	- / -
07	N007	-	- / -	- / -
08	N008	-	- / -	- / -
09	N009	-	- / -	- / -
10	N126	-	- / -	- / -
11	N122	-	- / -	- / -
12	N012	-	- / -	- / -
13	N013	-	- / -	- / -
14	N014	-	- / -	- / -
15	N123	-	- / -	- / -
16	N124	-	- / -	- / -

FIGURE 25. Status | Ports | AIO

### Frame Field

The **Frame** field is used to select the frame to be viewed.

### AIO Column

The **AIO** column displays the number of the physical AIO connector located on the back of the frame.



### Port Field

The **Port** field displays the port number and alpha assigned to the connector.

## Status Field

The **Status** field displays the connection status.

Available statuses are:

	The panel is connected.
	The panel was connected, but is no longer connected.
	There is no connection.

## Errors To/From Field

The **Errors To/From** field displays the number of errors that have occurred in sending and receiving messages via the AIO port.

## BER To/From Field

The **BER (Burst Error Rate) To/From** field displays the number of errors that have occurred in the last 10 minutes, when sending or receiving messages via the AIO port. If the intercom has been running less than 10 minutes, it prorates the number of errors that would occur in a 10 minute period at the same rate. For example, three errors in five minutes would be shown as a BER of 6.

The maximum displayed BER value is 255.

## 2-Wire

The **2-Wire** screen displays status information for the two connectors, CH A and CH B, located on the rear panel of ODIN.

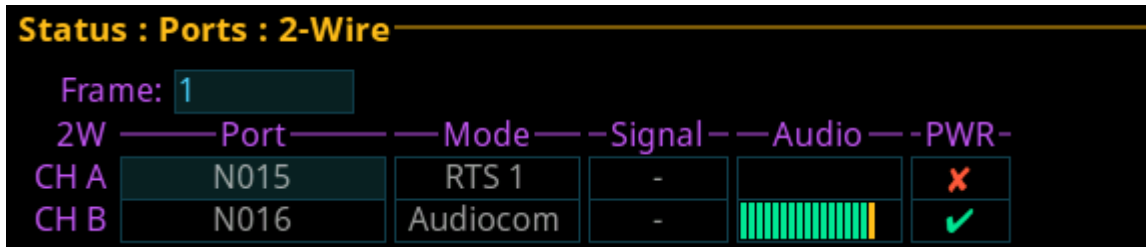

FIGURE 26. Status | Ports | 2-Wire

## Frame Field

The **Frame** field is used to select the frame to be viewed.

## Port Field

The **Port** field displays the port number and alpha assigned to the channel.

## Mode Field

The **Mode** field displays the operating mode of the channel.

Available modes are:

Off	No modes are active
RTS 1	RTS Channel 1 Mode
RTS 2	RTS Channel 2 Mode
Audiocom	Audiocom Mode (balanced)
Clear-Com	ClearCom Mode (unbalanced with DC call)

## Signal Field

The **Signal** field displays whether a signal has been detected on the 2-wire port.

Signals displayed are: *Mic Kill*, *Setup*, *Call*, and *DC Call*.

## Audio Field

The **Audio** field displays a real-time VU Meter (audio signal strength) for each port. The segmented bar graph is used to show audio is present on the port and the strength of the audio. Audio signals below -6 dB are shown in green, while signals between -6 dB and 0 dB are shown in yellow and signals greater than 0 dB are shown in red.

## PWR Field

The **PWR** field indicates whether ODIN detects DC Power (for example, voltage) on the 2W line. In most systems, there is a power supply like a PS-20 on the 2W line which provides power to the beltacks. This status indication could be useful to ensure that their system is set up correctly.

## Keypanel

The **Keypanel** screen is used to view the status information of connected keypanels.

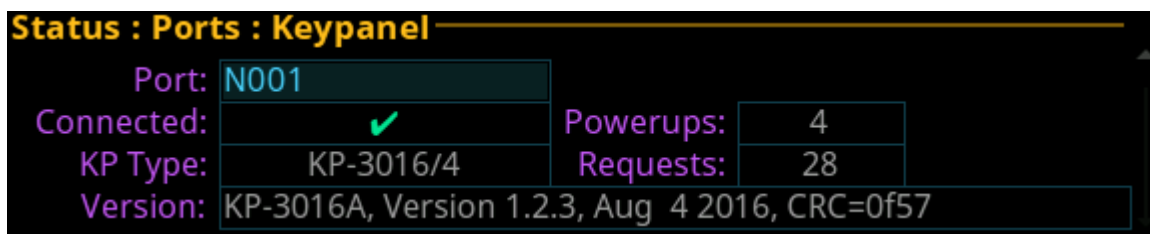

FIGURE 27. Status | Ports | Keypanel



## Port Field

The **Port** field is used to select the port to view.

### Connected Field

The **Connected** field displays the status information of the connection.

Available statuses are:

	The panel is connected.
	The panel was connected, but is no longer connected.
	There is no connection.

### KP Type Field

The **KP Type** field displays the type of keypanel connected to the intercom.

### Version Field

The **Version** field displays the firmware version currently loaded on the keypanel.

### Power Ups Field

The **Power Ups** field displays the number of times the keypanel has connected to the intercom.

### Requests Field

The **Requests** field displays the number of keypanel requests received by the intercom.

### TIF

The **TIF** screen is used to view the status information of any TIFs connected to the selected frame.

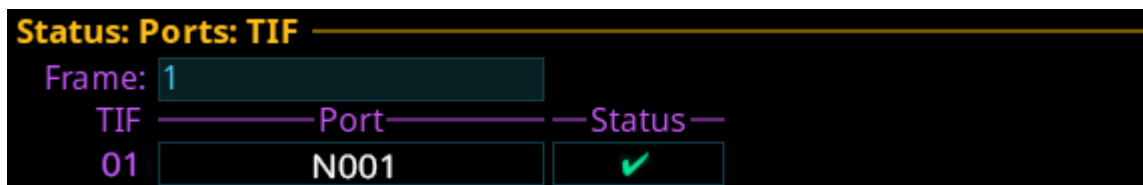

FIGURE 28. Status | Ports | TIF

### Frame Field

The **Frame** field is used to select the frame to be viewed.

### TIF Field

The **TIF** field displays the ports with TIFs connected.

### Port Field

The **Port** field displays the port to which the TIF is connected.

### Status Field

The **Status** field displays the status of the TIF.

Available states are:

- Off-hook*
- Ringing*
- (on-hook/idle)*

### Peripherals Menu

The **Peripherals** menu contains a list of the different types of peripheral devices available.

Device statuses include:

- Trunk Master*
- GPIO-16*
- LCP-102*
- PAP-32*
- PAP-5032*

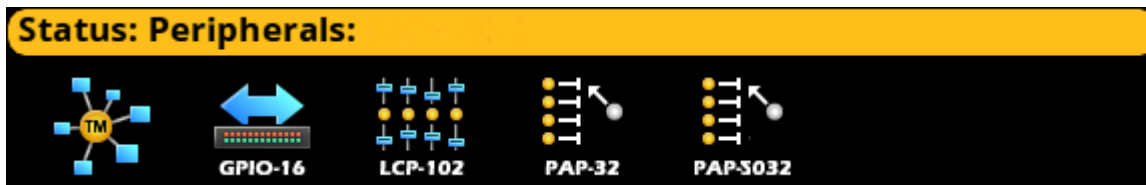

FIGURE 29. Status | Peripherals Menu Icons

### Trunk Master

The **Trunk Master** screen displays the status information of the Trunk Master(s) connected to the selected frame.

The image shows a screen titled 'Status: Peripherals: Trunk Master'. It displays 'TM Status: ✓' and a table with two columns: 'Link 1' and 'Link 2'. The table lists various connection metrics.





	Link 1	Link 2
TM Status:	✓	
Ethernet	Link 1	Link 2
Connected:	✓	-
Active:	✓	-
IP Address:	192.168.2.210	-
Link Ups:	1	-
Round Trip:	47 ms	-
Packets To:	577	-
Retransmits:	-	-
Packets From:	2268	-
Duplicates:	-	-

FIGURE 30. Status | Peripherals | Trunk Master

### TM Status Field

The **TM Status** field displays whether a Trunk Master is connected to the system.

Available statuses are:



	The TM is connected.
	The TM was connected, but is no longer connected.
	There is pending data being sent to the TM.
	There is no TM configured.

### Link 1 and Link 2 Columns

The **Link 1** and **Link 2** columns display the status information for the active and standby trunk master. A Trunk Master can consist of an active and standby pair. The intercom maintains links to both – Link 1 and Link 2.



#### Connected Field

The **Connected** field displays the connection status of the Ethernet link.

	The TM is connected.
	The TM was connected, but is no longer connected.
	There is no connection.

#### Active Field

The **Active** field displays whether the Trunk Master on this link is active.

	The TM is active.
	There TM is not active.

#### IP Address Field

The **IP Address** field displays the IP address of the Trunk Master.

#### Link Ups Field

The **Link Ups** field displays how many times a connection was established. Normally this value is very low (for example, 1 or 2); however if there are network problems, a higher number may display.

### Round Trip Field

The **Round Trip** field displays approximately how long, in milliseconds, it take for a message from the intercom to be acknowledged by the trunk master.

The round trip time reflects network delays. Since packets are not acknowledged immediately. The round trip time may be up to 50 mSec for local networks with low latencies. If the latency is excessive (several seconds or longer), the link may fail.

### Packets To Field

The **Packets To** field display the number of packets (for example, messages) sent to the trunk master from the intercom.

### Retransmits Field

The **Retransmits** field displays how many messages (for example, packets) needed to be retransmitted because no acknowledgement for those packets is received from the trunk master. This can happen if a message was dropped by the network, or if the round trip is high enough the intercom reset the message before it received the acknowledgement from the trunk master.

### Packets From Field

The **Packets From** field displays the number of packets (for example, messages sent) from the trunk master to the intercom.

### Duplicates Field

The **Duplicates** field displays how many messages (for example, packets) have been received by the trunk master more than once.

## GPIO-16

Status: Peripherals: GPIO-16			
Frame:	1		
GPIO-16	Status	Errors To / From	BER To / From
01	✓	- / -	- / -
02	-	- / -	- / -
03	-	- / -	- / -
04	-	- / -	- / -
05	-	- / -	- / -
06	-	- / -	- / -

FIGURE 31. Status | Peripherals | GPIO-16

### Frame Field

The **Frame** field is used to select the frame to be viewed.



### GPIO-16 Column

The **GPIO-16** column displays the number of the GPIO-16.

Each GPIO-16 handles 16 GPIO inputs and outputs. If the system is configured for 96 relays, there will be six GPIO-16s available.

### Status Field

The **Status** field displays the GPIO-16 port communication status.

	The GPIO-16 is connected.
	The GPIO-16 was connected, but is no longer connected.
	There is no connection.

### Errors To/From Field

The **Errors To/From** field displays the number of errors to and from the GPIO-16 logged by the intercom.

### BER To/From Field

The **BER To/From** field displays the number of errors to and from the GPIO-16 in the last 10 minutes.

## LCP-102

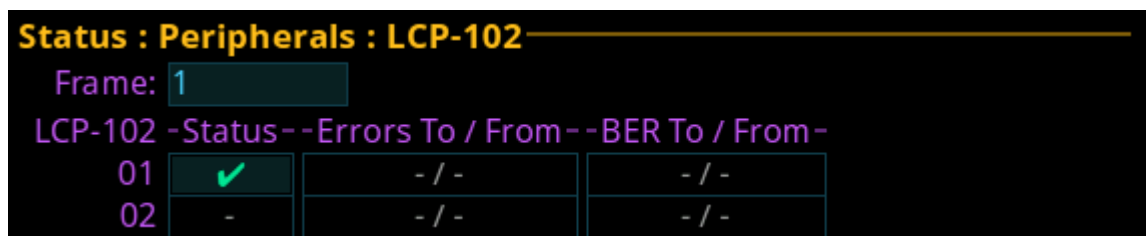

FIGURE 32. Status | Peripherals | LCP-102

### Frame Field

The **Frame** field is used to select the frame to be viewed.

### LCP-102 Column



The **LCP-102** column displays the LCP-102 number.

*Up to 15 LCP-102s can be connected to each frame.*

### Status Field

The **Status** field displays the LCP-102 port communication status.

Available port communication statuses are:

	The LCP-102 is connected.
	The LCP-102 was connected, but is no longer connected.
	There is no connection.



### Errors To/From Field

The **Errors To/From** field displays the number of errors to and from the LCP-102 logged by the intercom.

### BER To/From Field

The **BER To/From** field displays the number of errors to and from the LCP-102 in the last 10 minutes.

## PAP-32

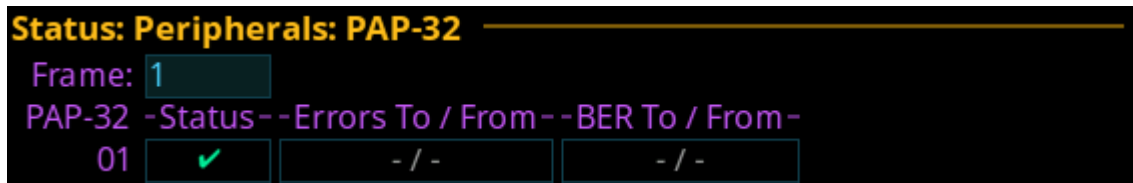

FIGURE 33. Status | Peripherals | PAP-32

### Frame Field

The **Frame** field is used to select the frame to be viewed.

### PAP-32 Column

The **PAP-32** column displays the PAP-32 number.

### Status Field

The **Status** field displays the PAP-32 port communication status.

	The PAP-32 is connected.
	The PAP-32 was connected, but is no longer connected.
	There is no connection.

### Errors To/From Field

The **Errors To/From** field displays the number of errors to and from the PAP-32 logged by the intercom.

### BER To/From Field

The **BER To/From** field displays the number of errors to and from the PAP-32 in the last 10 minutes.

## PAP-5032

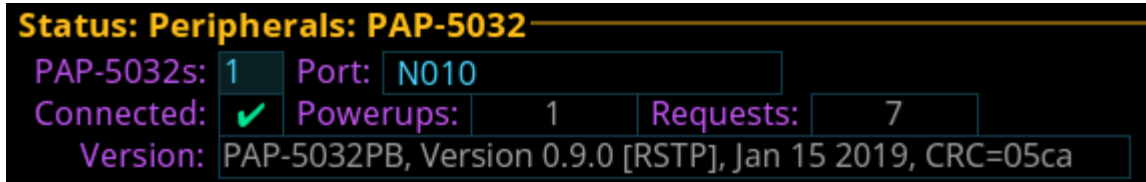

FIGURE 34. Status | Peripherals | PAP-5032

### PAP-5032s Field

The **PAP-5032s** field is used to select the PAP-5032 to view. The number of PAP-5032 allowed to select is directly related to the number of units defined in the Intercom Configuration screen (see “Reconfigure” on page 116).

If a PAP-5032 is not yet mapped and is selected, the port field displays (Not mapped).





### Port Field

The **Port** field is used to select the port to view. Only mapped ports appear in the scroll list.

### Connected Field

The **Connected** field displays the PAP-5032 port communication status.

Available port communication statuses are:

	The PAP-5032 is connected.
	The device connected is not a PAP-5032.
	The PAP-5032 was connected, but is no longer connected.
	There is no connection.

### Powerups Field

The **Powerups** field displays the number of times the panel reboots or loses and then regains its connection.

### Requests Field

The Requests field displays the number of times the panel sends a request to the intercom (for example, assigning a key, turning a listen key on/off, assigning a program source to an IFB, etc).

### Version Field

The **Version** field displays the firmware version currently loaded on the PAP-5032.

## Intercom Menu



FIGURE 35. Status | Intercom Menu

## GPIO

The **GPIO** screen displays status information for General Purpose Inputs and Outputs in the intercom.

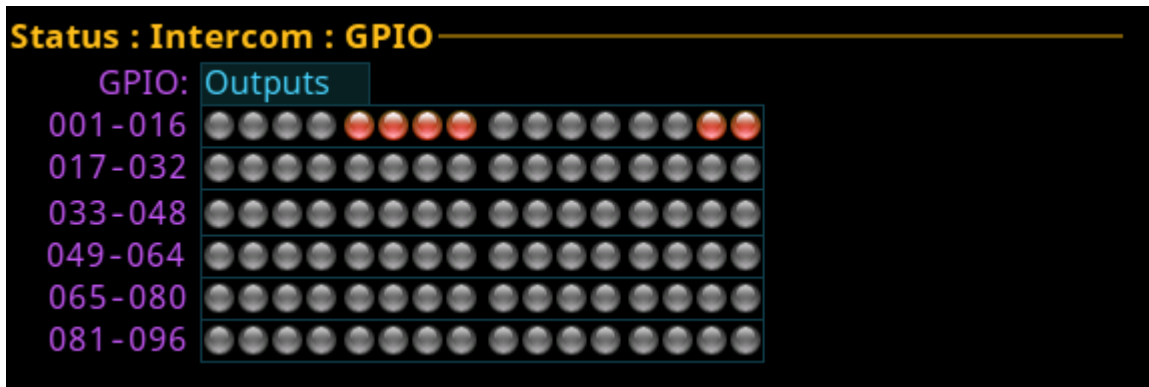

FIGURE 36. Status | Intercom | GPIO

### GPIO Selection Field

The **GPIO** selection field is used to select whether Input status or Output status is being displayed.

Status LED descriptions are:



*Active Inputs (green light)*



*Active Outputs (red light)*



*Inactive Inputs or Outputs (grey light)*

## Crosspoint Inspect

The **Crosspoint Inspect** screen displays the crosspoint status for the selected input and output ports.

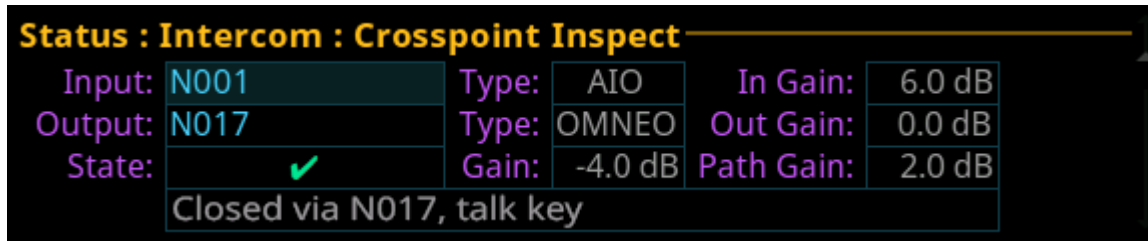

FIGURE 37. Status | Intercom | Crosspoint Inspect

### Input Field

The **Input** field displays the input port alpha.

**NOTE:** To change the input port being displayed, when the focus is on the input field, press the right encoder knob, and then turn the left encoder knob to scroll through port numbers.

### Type Field

The **Type** field displays the input port type.

### In Gain Field

The **In Gain** field displays the input gain for the input port.

### Output Field

The **Output** field displays the port on which output audio is sent.

**NOTE:** To change the output port being displayed, when the focus is on the output field, press the right encoder knob, and then turn the left encoder knob to scroll through port numbers.

### Type Field

The **Type** field displays the output port type.



### Out Gain Field

The **Out Gain** field displays the output gain for the output port.

### State Field

The **State** field displays the state of the crosspoint.

The available states are:

	The crosspoint is closed.
	The crosspoint is inhibited (prevented from being closed, even if it would otherwise be closed).
	The crosspoint is open (no reason to close or inhibit).

## Gain Field

The **Gain** field displays the crosspoint gain.

## Path Gain Field

The **Path** Gain field displays the overall gain that takes into account the input and output gains, as well as the crosspoint gain.

## Frame to Frame (Multi-frame Only)

The **Frame to Frame** screen is used to view communication status information for the current frame to a selected frame.

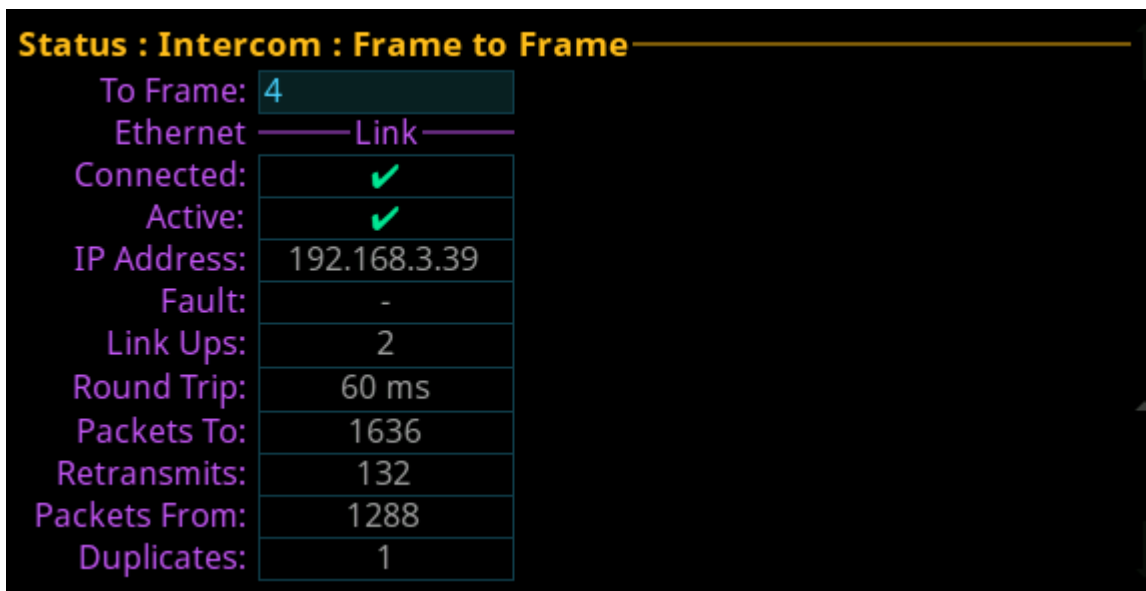

FIGURE 38. Status | Intercom | Frame to Frame

## To Frame Field



The **To Frame** field displays the connection information from the current frame to the selected frame.

## Link Field

The **Link** field displays the connection information for the selected frame.



## Connected Field

The **Connected** field displays the connection status for the Ethernet link.

	The frame is connected.
	The frame was connected, but is no longer connected.
	There is no connection.

## Active Field

The **Active** field displays whether or not the fiber link is active.

	The frame is connected.
	There is no connection.

## IP Address Field

The **IP Address** field displays the IP address of the selected frame.

## Faults Field

The **Faults** field displays a red x if two frames are connected to form a multi-frame intercom, but the configurations do not match. When two frame configurations do not match, the intercom prevents the frames from communicating with each other. If the frames continue to operate autonomously even though the link between them is up, the fault icon is displayed.

 There are no errors.

 An error has occurred. While the field is highlighted, press the SEL button to display a fault description.

Faults include:<sup>a</sup>

<i>Frame ID Mismatch: The other frame thinks this is Frame &lt;N&gt;</i>	Indicates this frame and the other frame disagree as to the number of this frame, with <N> being the number that the other frame expects.
<i>Frame ID Mismatch: The other frame is &lt;N1&gt; not &lt;N2&gt;</i>	Indicates with <N1> what this frame expects the other frame to be numbered, and <N2> what the other frame is reporting at its number.
<i>Frame ID Mismatch: The other frame is also frame &lt;N&gt;</i>	Indicates both this frame and the other frame have the same number <n>.
<i>The other frame has a different configuration than this frame</i>	Indicates the intercom configuration between frames is not identical.
<i>Link is inactive (unknown cause)</i>	Indicates the link is inactive with no known cause.
<i>No State Information Received</i>	Indicates no status information is available.

a. An <N> or similar symbol with the message text denotes a numeric value inserted by the software at runtime.

## Link Ups Field

The **Link Ups** field displays how many times a connection was established.

## Round Trip Field

The **Round Trip** field displays approximately how long, in milliseconds, it takes for a message from the intercom to be acknowledged.

**NOTE:** Round Trip is an average value. It should never be any higher than a predetermined maximum (currently 5 seconds). If this value goes higher, the link may fail.

The range for this field is 0 – 5.

## Packets To Field

The **Packets To** field displays the number of packets (for example, messages) sent to the frame from this frame.

### Retransmits Field

The **Retransmits** field displays approximately how many messages (for example, packets) needed to be retransmitted because no acknowledgement for those packets was received by the frame.

### Packets From Field

The **Packets From** field displays the number of packets (for example, messages) sent from the selected frame and received by this frame.

### Duplicates Field

The **Duplicates** field displays how many messages (for example, packets) have been received by the select frame more than once.

## IFL

The **IFL** screen is used to display and monitor the Inter-Frame Link status between frames. For more information on IFL, see “IFL Inter-Frame Linking (Multi-Frame Only)” on page 41.

When referring to a multi-frame (more than one frame) system connected via IFL, the use of the terms upstream and downstream indicate the immediate frame above or below the current frame in the IFL system. For example, frame 1’s downlink is frame 2; frame 2’s downlink is frame 3. Since IFL uses ring architecture, the last frame in the system is linked to the first. So, the downlink from the last frame in the system will be connected to the uplink of first frame.

Status: Intercom: IFL			
Frame: 4			
Primary Uplink			
Connected:	✓	Fault:	-
To Frame:	3	Tx Messages:	542
To Link:	Primary Downlink	Rx Messages:	536
IP Address:	192.168.0.30	Rx Errors:	-
SFP Installed:	✓	SFP Tx Fault:	-
Tx Power:	0.282 mW	Rx Power:	0.396 mW
Secondary Uplink			
Connected:	✓	Fault:	-
To Frame:	3	Tx Messages:	769
To Link:	Secondary Downlink	Rx Messages:	762
IP Address:	192.168.0.30	Rx Errors:	-
SFP Installed:	✓	SFP Tx Fault:	-
Tx Power:	0.285 mW	Rx Power:	0.634 mW
Primary Downlink			
Connected:	✓	Fault:	-
To Frame:	5	Tx Messages:	758
To Link:	Primary Uplink	Rx Messages:	662
IP Address:	192.168.0.50	Rx Errors:	-
SFP Installed:	✓	SFP Tx Fault:	-
Tx Power:	0.278 mW	Rx Power:	0.588 mW
Secondary Downlink			
Connected:	✗	Fault:	-
To Frame:	-	Tx Messages:	-
To Link:	-	Rx Messages:	1358
IP Address:	-	Rx Errors:	-
SFP Installed:	✓	SFP Tx Fault:	-
Tx Power:	0.285 mW	Rx Power:	0.849 mW

FIGURE 39. Status | Intercom | IFL

## Frame Field

The **Frame** field is used to select the frame to be viewed.

---

**IMPORTANT:** Since the Primary and Secondary Uplinks and Downlinks fields are exactly the same, the following field descriptions apply to all four sections.

---

## Primary/Secondary Uplink/Downlink

The **Primary/Secondary Uplink/Downlink sections** display the communication status of the connectors located on the back panel of the ODIN frame.

### Connected Field



The **Connected** field displays the status of the IFL communication link between frames.

Available statuses are:

	IFL is connected.
	IFL is installed but not connected.
	No IFL is installed.

### Fault Field

The **Fault** field displays physical wiring faults detected in the IFL configuration, if any. Faults seen can be uplink to uplink or downlink to downlink wiring.

	<p>There are faults.</p> <p>To <b>display the type of fault</b>, do the following:</p> <ol style="list-style-type: none"> <li>1. Rotating the right encoder knob, navigate to the <b>Fault field</b>.</li> <li>2. Click the <b>right encoder knob</b>.</li> </ol> <p>OR</p> <p>Press the <b>SEL key</b>.</p> <p>The types of faults that can be see are:</p> <ul style="list-style-type: none"> <li>• Unknown Fault</li> <li>• Uplink port connected to uplink port</li> <li>• Downlink port connected to downlink port</li> <li>• Frame linked to itself</li> <li>• Unrecognizable frame</li> <li>• Frames wired out of order</li> <li>• Frame mapping tables disagree on frame identity</li> <li>• Number of frames in system size differs</li> </ul>
	There are no faults.



**To Frame Field**

The **To Frame** field displays the number of the frame connected to the Primary/Secondary Uplink/Downlink connector on the current frame.

**Tx Messages Field**

The **Tx Messages** field displays the number of messages sent from the ODIN frame.

**To Link Field**

The **To Link** field displays the physical connection to which the frame is connected. For example, the Primary Uplink connector of the current frame would show it being connected to the Primary Downlink of the next frame in the system.

**Rx Messages Field**

The **Rx Messages** field displays the number of messages received.

**IP Address Field**

The **IP Address** field displays the IP address of the frame being linked to.



**Rx Errors Field**

The **Rx Errors** field displays the number of errors received.

**SFP Installed Field**

The **SFP Installed** field displays whether or not an SFP module is installed in the frame.

Available statuses are:

	SFP is installed.
	No SFP is installed.

**SFP Tx Fault Field**

The **SFP Tx Fault** field displays if a fault has occurred on the link.

**Tx Power Field**

The **Tx Power** field displays the amount of power used to transmit the outgoing fiber signal.

**Rx Power Field**

The **Rx Power** field displays the amount of power being received from the incoming fiber signal.

## Hardware Menu

The **Hardware** menu is used to access the status of the different hardware in the ODIN frame, such as power supplies, cooling fans, temperature, and word clock.



FIGURE 40. Status | Hardware Menu

## Power Supplies

The **Power Supplies** menu item displays power levels for the different power supplies used by the frame. The frame self-monitors the power used and if it finds any power levels outside the recommended operating conditions, an alarm is generated.

---

**IMPORTANT:** This information is for diagnostic purposes only!

---

 A screenshot of the 'Status: Hardware: Power Supplies' menu. It shows a table with columns for Supply, Voltage, Min, Max, Current, Min, and Max. The data is for Frame 1.
 

Supply	Voltage	Min	Max	Current	Min	Max
0.9V	0.90V	0.90V	0.90V	3.84A	3.40A	3.96A
0.95V	0.95V	0.95V	0.95V	0.43A	0.39A	0.44A
5.0V	5.02V	5.02V	5.03V	3.84A	3.61A	3.99A
3.3V	3.26V	3.26V	3.26V	0.64A	0.62A	0.66A
12V-1	12.00V	12.00V	12.00V	2.91A	2.82A	2.98A
12V-2	-	-	-	-	-	-

FIGURE 41. Status | Hardware | Power Supplies

### Frame Field

The **Frame** field is used to select the frame to be viewed.

### Supply Field

The **Supply** field displays the different power supply voltages.

Voltages include: 0.9V, 0.95V, 5.0V, 3.3V, 12V-1 (PS 1), and 12V-2 (PS 2).

### Voltage Field

The **Voltage** field displays the latest voltage reading.

### Min Field

The **Min** field displays the minimum voltage the power supply has recorded.

This value resets at reboot.

### Max Field

The **Max** field displays the maximum voltage the power supply has recorded.

This value resets at reboot.

### Current Field

The **Current** field displays the latest current reading.

### Min Field

The **Min** field displays the minimum current recorded on the power supply.

This value resets at reboot.

### Max Field

The **Max** field displays the maximum current recorded on the power supply.

This value resets at reboot.

## Cooling Fans

The **Cooling Fans** menu item displays fan readings for the frame. ODIN has five cooling fans located on the left panel of the frame. They are used to keep the frame and its components cool to ensure proper operation. The frame self-monitors the fans and if the readings are outside the recommended operating conditions, an alarm is generated.

**NOTE:** Only three fans are active at a given time. One failed fan does not mean the entire fan tray needs to be replaced.

For information on replacing the fan bank, see “Fan Tray” on page 69.

---

**IMPORTANT:** This information is for diagnostic purposes only!

---

Status: Hardware: Cooling Fans					
Frame:	1				
	Fan 1	Fan 2	Fan 3	Fan 4	Fan 5
Active	✓	-	✓	-	✓
Fault	-	-	-	-	-
RPM	9219	-	9023	-	9200

FIGURE 42. Status | Hardware | Cooling Fans

### Frame Field

The **Frame** field is used to select the frame to be viewed.

### Fan 1 through Fan 5 Field

The **Fan 1 through Fan 5** fields are used to display status for the individual fans which can be used to monitor or narrow down fan problems. Fan 1 is at the rear of the frame.

### Active Field

The **Active** field displays which fans are currently active. A green check mark signifies the fan is active, a blank field signifies the fan is not running.

## Fault Field

The **Fault** field displays if a fault has occurred on a fan. A red X indicates a fault has occurred.

## RPM Field

The **RPM** field displays the speed or **RPM** (Revolutions Per Minute) the fan is operating.

- If the fan speed is within the normal operating range, the entry is shown in green (Normal).
- If the fan speed is outside the normal operating range, but not in the alarm state, the entry is shown in yellow (Marginal).
- If the fan speed is outside the marginal operating range, the value is shown in red (Alarm).

## Temperatures

The **Temperatures** menu item displays temperature readings for different components inside the ODIN frame. There are 10 sensors that record temperatures across the frame. The frame self-monitors temperatures across the board and if it finds any temperatures outside the recommended operating conditions, an alarm is generated.

- If the temperature is within the normal operating range, the entry is shown in green (Normal).
- If the temperature is outside the normal operating range, but not in the alarm state, the entry is shown in yellow (Marginal).
- If the temperature is outside the marginal operating range, the value is shown in red (Alarm).

---

**IMPORTANT:** This information is for diagnostic purposes only!

---

Status: Hardware: Temperatures			
Frame:	1		
Sensor	Temperature	Min	Max
Main CPU (internal)	+51°C	+35°C	+55°C
Main CPU (external)	+47°C	+45°C	+48°C
Audio FPGA	+52°C	+51°C	+52°C
FP CPU (external)	+39°C	+36°C	+40°C
AC/DC supplies	+45°C	+45°C	+48°C
Power Management IC	+41°C	+41°C	+44°C
15VDC Regulator	+39°C	+39°C	+51°C
12VDC Regulator	+57°C	+57°C	+60°C
12VDC Supply #1	+52°C	+52°C	+55°C
12VDC Supply #2	+50°C	+50°C	+53°C

FIGURE 43. Status | Hardware | Temperatures

## Frame Field

The **Frame** field is used to select the frame to be viewed.

## Sensor Field

The **Sensor** field displays the names of the different temperature sensors being monitored on the frame.

## Temperature Field

The **Temperature** field displays the current temperature of the specific sensor. Temperatures are only shown in Celsius.

## Min Field

The **Min** field displays the lowest recorded temperature of the sensor from the time ODIN was powered on.

## Max Field

The **Max** field displays the highest recorded temperature of the sensor from the time ODIN was powered on.

## Clock

The **Clock** menu item refers to the word clock. The word clock is a signal generated and sent out to other devices within a network to synchronize audio sent over Ethernet. Simply stated, a word clock master (where the word clock is generated) sends a signal out to the other devices in the network to keep synchronicity of audio between devices on the network.



FIGURE 44. Status | Hardware | Clock

## Frame Field

The **Frame** field is used to select the frame to be viewed.

## Clock Source Field

The **Clock Source** field displays the clock mode of the frame. Frames can either be the master (generate) word clock or the slave that receives the word clock with which to synchronize.

Available states for this field are:

<i>Network / Slave</i>	ODIN receives its PTP clock from another device on the network.
<i>External / Coax</i>	ODIN receives its PTP clock from an external clock via Sync Input connector located on the back of the frame.
<i>Internal / Master</i>	ODIN generates the PTP clock as the Master Clock for other devices on the network.

## External Clock Status

The **External Clock Status** field displays the status of the Sync Input connector, if enabled. This connector is used to synchronize external devices attached to the intercom system.

Available states for this field are:

<i>Missing</i>	The external clock is not present.
<i>Good</i>	The external clock is present and valid.
<i>Out Of Sync</i>	The external clock is present but not valid.

## PTP Clock Status Field

The **PTP Clock Status** field displays the synchronization status of the device to other devices on the network. **PTP** (Precision Time Protocol) is used to synchronize clocks throughout the network.

Available states for this field are: *Linked* or *Unlinked*.

### Preferred Master Check Box

The **Preferred Master** check box determines whether the frame is configured as the preferred master word clock.

### Enable Sync to External Check Box

The **Enable Sync to External** check box determines whether the frame is configured to synchronize with the external clock signal provided on the Sync Input coax connector on the rear panel.

## Configuration Menu



FIGURE 45. Configuration Menu Icons

The **Configuration** menu is used design the initial structure of the intercom system. This includes intercom size, resource allocation, network connections, port assignments, peripheral device setup, security, user interface settings, and advanced features such as DHCP, SNMP, and word clock settings. These settings, once configured, are seldom changed.

**IMPORTANT:** Changes made to front panel settings are saved to flash immediately. However, changes made to Intercom Setup may not be saved for up to 5 minutes after the change is made.

## System Menu

The available items for system configuration include *Intercom Size*, *Frame Mapping Table*, *Port Allocation Table*, and *Intercom Name*.

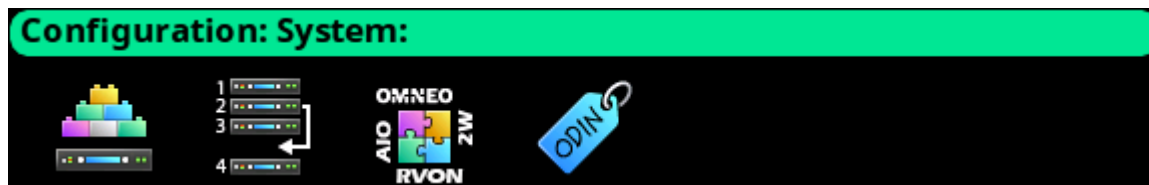

FIGURE 46. Configuration | System Menu Icons

## Intercom Size

From the **Intercom Size** menu the intercom can be reconfigured, frames can be added or removed, or the intercom split into two pieces.



FIGURE 47. Configuration | System | Intercom Size Menu Icons (Multi-Frame System)

The split intercom icon only appears when two or more frames are in the downstream line from the current frame. For example, in a 5-frame system, the icon only displays in frames 1, 2, and 3.



FIGURE 48. Configuration | System | Intercom Size Menu Icons (Single Frame System)

Adding a frame or multiple frames is only possible from the last frame in the intercom. Removing a frame (or frames) is only possible from a frame that is not the last frame in the intercom.

## Reconfigure

The **Reconfigure** screen is used to set the intercom size, the number of each resource type, and other intercom configuration options.

**Configuration: System: Intercom Size: Reconfigure**

Frames:	3	Ports in Frame 1:	128	(1-128)
Total Ports:	384	Ports in Frame 2:	128	(129-256)
Party Lines:	96	Ports in Frame 3:	128	(257-384)
IFBs:	16			
IFB SLs:	32			
Special Lists:	64			
GPI Outputs:	96			
ISOs:	16			
AGRPs:	32			
UPL Resources:	120	Talk Levels:	2	
UPL Statements:	256	Panels w/ Key Labels:	16	
Auto Dials:	64	Key Labels per Panel:	64	
GPI Inputs:	96	Keys per Port:	64	
Dim Tables:	32	Setup Pages:	15	
PAP-5032s:	5	Max IFB Priority:	8	
Input Alphas:	<input checked="" type="checkbox"/>	Unicode Alphas:	<input checked="" type="checkbox"/>	
Trunk Tallies:	<input checked="" type="checkbox"/>	Auto-X pickup all talk:	<input checked="" type="checkbox"/>	
TIF Tallies:	<input checked="" type="checkbox"/>	Autonomous when no IFL:	<input checked="" type="checkbox"/>	
Snoop Tallies:	<input checked="" type="checkbox"/>	Always stack in CWW:	<input checked="" type="checkbox"/>	
		Clear existing setup:	<input checked="" type="checkbox"/>	
Resource Usage —Existing— -Proposed-				
Operation Memory:		2 %		2 %
Configuration Memory:		4 %		4 %
Remote Alpha Pool:		0 %		0 %

FIGURE 49. Configuration | System | Intercom Size | Reconfigure

### Frames Field

The **Frames** field sets the number of frames in the intercom system.

### Total Ports Field

The **Total Ports** field sets the number of ports in the intercom system. When multiple frames are used, this field displays the total number of ports available across every connected frame.

**NOTE:** Modifications to the Total Ports field can only be made in a single frame system.



---

### Ports in Frame <n> Field

The **Ports in Frame <n>** field identifies the number of ports in each frame in the system.

---

**IMPORTANT:** The number of ports in each frame must be a multiple of 16.

---

### Party Lines Field

The **Party Lines** field sets the number of party lines in the intercom system.

The range for this field is *0 to 999*.

### IFBs Field

The **IFBs** field sets the number of IFBs in the intercom system.

The range for this field is *0 to 999*.

### IFB SLs Field

The **IFB SL** (Special Lists) field sets the number of IFB SLs in the intercom.

The range for this field *0 to 999*.

### Special Lists Field

The **Special Lists** field sets the number of Special Lists in the intercom.

The range for this field is *0 to 999*.

### GPI Outputs Field

The **GPI Outputs** field sets the number of GPI Outputs allowed in the intercom. Each frame has four onboard GPIO. In a multi-frame system, if a GPIO-16 is added as GPIO 1 (GPIO 1-16), the GPIO in the GPIO-16 parallel the four onboard GPIO on the frame.

For example, input on GPIO 6 (the second GPIO on frame 2) is the same as GPIO-16 input 6 (if either is triggered, the GPIO 6 is active). Similarly, when GPIO output 6 is activated, it activates on both frame 2, the second GPIO (#6), and on the GPIO-16 (#6). Both outputs are activated at the same time.

The maximum number of GPIO outputs is 256 (16 GPIO-16s supported).

The number of GPIO Outputs must be a *multiple of 16*.

### ISOs Field

The **ISOs** field sets the number of ISOs in the intercom.

The range for this field is *0 to 999*.

### AGRPs Field

The **AGRPs** field sets the number of AGRPs (Assignment Groups) in the intercom.

The range for this field is *0 to 999*.

### UPL Resources Field

The **UPL Resources** field sets the number of UPL Resources in the intercom.

The range for this field is *0 to 999*.

### UPL Statements Field

The **UPL Statements** field sets the number of UPL Statements in the intercom.

The range for this field is *0 to 2000*.

### Auto Dials Field

The **Auto Dials** field sets the number of auto dial entries in the intercom.

The range for this field is *0 to 999*.

### GPI Inputs Field

The **GPI Inputs** field sets the number of GPI Inputs allowed in the intercom. Each frame has four onboard GPIO. In a multi-frame system, if a GPIO-16 is added as GPIO 1 (GPIO 1-16), the GPIO in the GPIO-16 parallel the four onboard GPIO on the frame.

For example, input on GPIO 6 (the second GPIO on frame 2) is the same as GPIO-16 input 6 (if either is triggered, the GPIO 6 is active). Similarly, when GPIO input 6 is activated, it activates on both frame 2, the second GPIO (#6), and on the GPIO-16 (#6). Both inputs are activated at the same time.

The maximum number of GPIO inputs is *256* (16 GPIO-16s supported).

The number of GPIO Inputs must be a *multiple of 16*.

### Dim Tables Field

The **Dim Tables** field sets the number of Dim Tables in the intercom.

The range for this field is *0 to 999*.

### PAP-5032s Field

The **PAP-5032s** field sets the number of PAP-5032 devices in the intercom.

The range for this field is *0 to 64*.

### Talk Levels Field

The **Talk Levels** field sets the number of Talk Levels in the intercom.

By default this field is set to *2*.

The range for this field is *2 to 4*.

### Panels with Key Labels Field

The **Panels with Key Labels** field sets the number of keypanels allowed to have key labels.

By default, this value is set to *16*.

### Key Labels per Panel Field

The **Key Labels Per Panel** field sets the number of key labels allowed per keypanel. The maximum number of key labels per panel depends on how many keys per port are configured.

By default, this value is set to *64*.

### Keys Per Port Field

The **Keys Per Port** field sets the number of keys per port in the intercom.

Available options for this field are *64, 96, or 128*.

### Setup Pages Field

The **Setup Pages** field sets the number of setup pages per port. The minimum value for this field depends upon the number of keys per port. The number of setup pages is determined by dividing the keys per port by 16 (for example, 64 keys would need 4 setup pages).

The maximum number of setup pages is *15*.

### Max IFB Priority Field

The **Max IFB Priority** field sets the highest priority allowed to be assigned to a keypanel. IFB priorities determine which keypanel gets first access to an IFB in cases where two or more keypanels are trying to access the IFB at the same time. By default, the IFB priority for each intercom port can be individually set to any number from 0 through 3. With the priority set to 3, the keypanel overrides any other keypanel set to a lower priority. Keypanels set to the same priority can simultaneously interrupt the same IFB.

This field value can range from *1 to 8*.

### Input Alphas Check Box

The **Input Alphas** check box determines whether input alphas are enabled for the intercom. If Input Alphas are enabled, each port has both an input alpha and an output alpha, as opposed to a single port alpha.

### Trunk Tallies Check Box

The **Trunk Tallies** check box determines whether the intercom generates trunk in-use tallies. If a key with a remote assignment is turned on, and a trunk is allocated to satisfy the request, an in-use tally is generated if this check box is selected.

### TIF Tallies Check Box

The **TIF Tallies** check box determines whether a tally is generated when a TIF id off-hook. A tally is always generated when a TIF is ringing.

### Snoop Tallies Check Box

The **Snoop Tallies** check box determines whether snoop tallies are enabled for the intercom. Snoop tallies indicate to keypanel users that somebody is listening to them. Snoop Tallies, if enabled, are only generated if the keypanel has Hot Mic enabled.

### Clear Existing Setup Check Box

The **Clear Existing Setup** check box determines whether the existing setup should be cleared. By default, the existing setup is preserved when the intercom is resized.

### Unicode Alphas Check Box

The **Unicode Alphas** check box enables or disables support for unicode alphas.

### Auto X Pickup All Talk Check Box

The **Auto-X Pickup All Talk** check box determines whether an auto-listen function works on all talk levels or just the first talk level on a key.

### Autonomous When No IFL Check Box

The **Autonomous When No IFL** check box is used to force the current frame into autonomous (independent) mode, if none of its IFL audio links are active. If selected, the frame refuses to communicate with any other frames if none of its IFL links are up, even if Ethernet communications are fine. Once one or more of its audio links are restored, the frame automatically tries to re-establish Ethernet links to the other frames in the system.

### Always Stack in CWW Check Box

The **Always Stack in CWW** check box determines whether callers are always stacked in the call waiting window. When not selected, a caller is only placed in the CWW if the keypanel receiving the call does not have the caller's assignment on a key.

## Resource Usage Table

The **Resource Usage** table displays resource usage information for the system. There are two columns that display Existing and Proposed usage.

<i>Existing column</i>	Displays the percentage of the RAM or flash that is used by the current system configuration.
<i>Proposed column</i>	Displays the percentage of RAM or flash that would be used in the new system size configured above.

## Operation Memory Field

The **Operation Memory** field displays the amount of RAM used.

## Configuration Memory Field

The **Configuration Memory** field displays the amount of flash memory (permanent storage) used.

## Remote Alpha Pool Field

The **Remote Alpha Pool** field displays how much space is used to store remote alphas (alphas from a trunk system). The amount of RAM available in the remote alpha pool may be limited by the amount of Operation Memory required. For large systems, more RAM is required for Operation Memory, reducing the amount of RAM available for the Remote Alpha Pool.

## Add Frames

The **Add Frames** menu is used to combine two or more frames that are connected via the IFL connection into a single unified intercom. See “IFL Inter-Frame Linking (Multi-Frame Only)” on page 41.

Up to *eight frames* can be connected via IFL.

**NOTE:** Only the last frame in a system can add frames to the system. For example, in a 4-frame system, Add Frames is only available on frame 4.

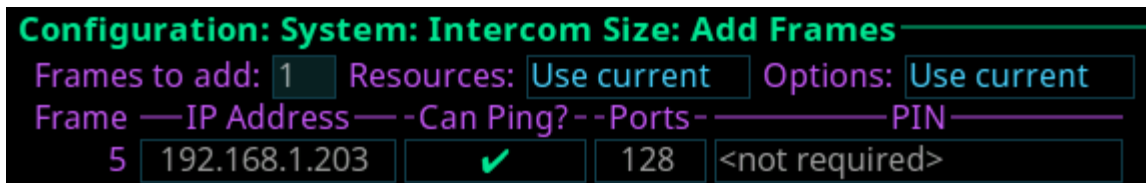

FIGURE 50. Configuration | System | Intercom Size | Add Frames

## Frames to Add Field

The **Frames to Add** field displays the number of frames to add to the intercom. Initially, this number is set to the number of new frames detected via the IFL. However, this field can be modified.

## Resources Field

The **Resources** field is used to select what resource set to use.

Available options are:

<i>Use Current</i>	Use the current resource set from the frame performing the Add operation.
<i>Use Largest</i>	Use the largest value for each resource item.
<i>Customize</i>	Customize the resource set to use. (See “Reconfigure” on page 116.)

## Options Field

The **Options** field is used to select what Options set to use.

Available options are:

<i>Use Current</i>	Use the current option set from the frame performing the Add operation.
<i>Use Merged</i>	Merge the options from both the current frame and the frame being added.
<i>Customize</i>	Customize the option set to use. (See “Reconfigure” on page 116.)

## Frame Field

The **Frame** field displays the frame or frames to add to the intercom.



## IP Address Field

The **IP Address** field displays the IP address of the frame being added.

This field is not editable.

## Can Ping? Field

The **Can Ping?** field determines if the frame can be pinged by the system. If the frame cannot be pinged, it indicates the intercom cannot establish communications via the Control Port Interface with the new frame.

	The frame can be pinged.
	The frame cannot be pinged.

## Ports Field

The **Ports** field displays the number of ports licensed on the frame.

This field is not editable.

## PIN Field

The **PIN** field displays whether front panel authentication is enabled on the frame being added.

If a PIN is required, it must be entered on each frame that requires it to complete the reconfiguration.

To **Add a Frame to the System**, do the following:

1. Connect an **IFL cable between two frames**.
2. Select the **Add Frames menu item**.

*The Searching for available frames... and Connect an IFL messages blink alternately.*



If a frame is found, the New frame detected message appears.

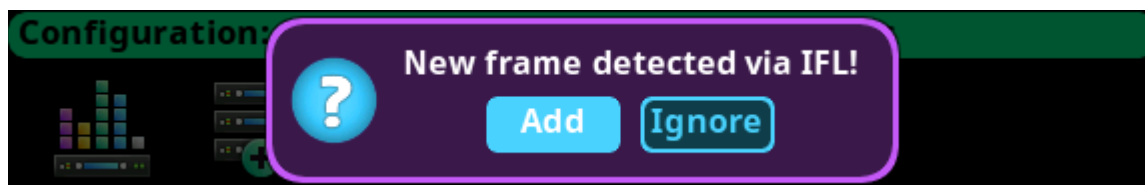

3. Select **Add** to add the frame.

The Add Frames screen appears.

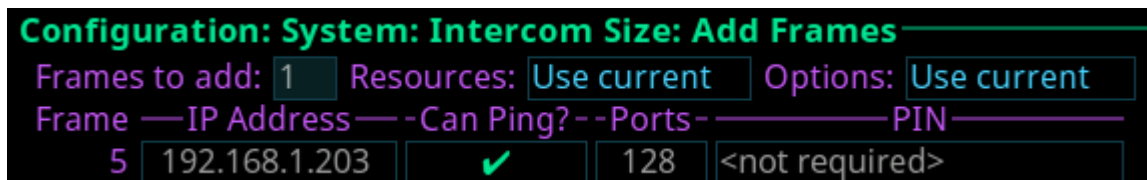

OR

Select **Ignore** to exit the function.

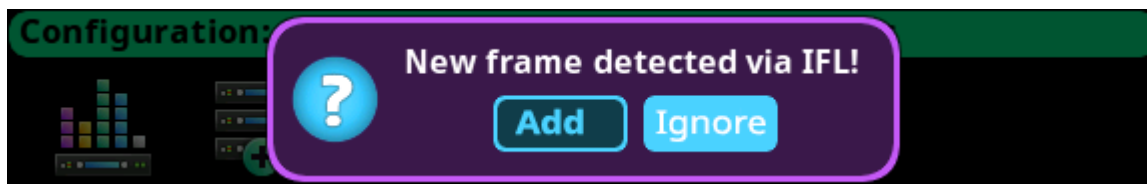

OR

If no frames are found, a No new frames were discovered menu briefly appears.



## Remove Frames

The **Remove Frames** menu is used to separate two or more frames connected via the IFL connection. See “IFL Inter-Frame Linking (Multi-Frame Only)” on page 41.

Remove Frames disconnects each frame downstream from the frame being removed. When removing frames, all frames downstream from the current frame (the frame where the remove frame is performed) are split into single frame systems. For example, if the remove frame operation is performed at frame 2 of a 5-frame system, the result is a 2-frame system (Frames 1 & 2) and three individual frames (Frames 3, 4, and 5). Frames 1 and 2 are sized to be a 2-frame system, while each of the other frames is resized to be a single frame.

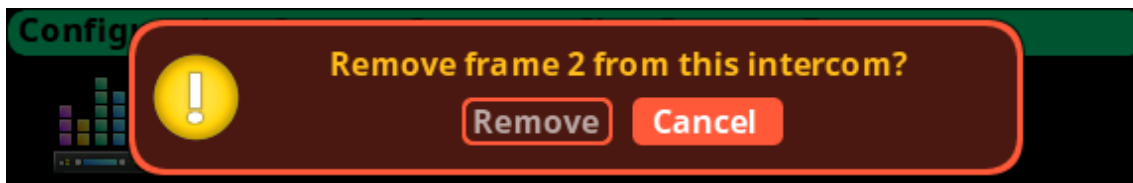

FIGURE 51. Remove Frame Verification Message

---

**IMPORTANT:** Once the frame(s) are removed from the system, remove the IFL connections from those frames.

---

To **remove a frame from the system**, do the following:

1. Select the **Remove Frame icon**.  
*The Remove Frame message appears.*
2. Select the **Remove button**.  
*The Press Home button 5 times message appears.*

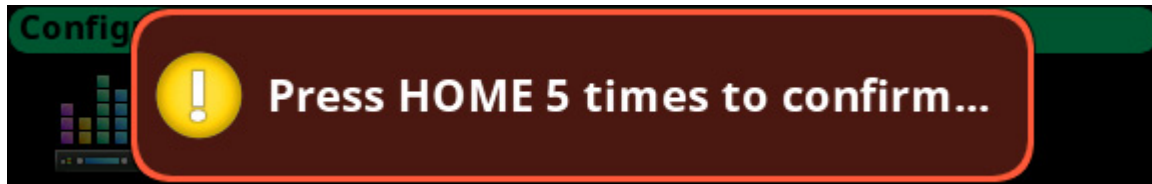

3. Press the **Home button five times**.  
*The frame reboots.*
4. Remove the **IFL connections** from the frames removed.

## Split Intercom

The **Split Intercom** menu is used to break larger intercom systems into smaller systems. Where the Remove Frame menu is used to remove individual frames from an intercom system, the Split Frame menu is used to remove a block of frames from one system to create two smaller intercom systems with multiple frames in each.

When splitting frames, all frames downstream from the current frame (the frame where the split is performed) are split off to create two smaller intercom systems. For example, the split frame operation is performed at frame 2 of a 5-frame system, the result is a 2-frame system (Frames 1 & 2) and a 3-frame system (Frames 3 through 5). Frames 1 and 2 resize to be a 2-frame system. The new setup is preserved and the frames reboot. When the frames come back online, they establish communications, and synchronize with each other and then reboot becoming a 2-frame system. Frames 3, 4 and 5, resize to a 3-frame system (frames 1, 2, and 3). The new setup is preserved and the frames reboot. When the frames come back online, they establish communications, and synchronize with each other and then reboot becoming a 3-frame system.

If the Split Intercom operation is performed on a system with a frame not currently communicating (the frame is powered off), the non-communicating frame is left alone, and the operation continues. For example, frame 3 of a 5-frame system is powered off and a split intercom is performed on frame 2 of the system. Frames 1 and 2 become a 2-frame system, frames 3, 4 and 5 become a 3-frame system, even though frame 3 is off. Once frame 3 is powered on, it does not recognize a split has occurred, and still thinks it is frame 3 of a 5-frame system. Because it cannot communicate with the other frames, it switches to autonomous operation. It's local keypanels still power up, but have no communication with the previous system's port assignments. Consequently, none of the ports that were assigned to frame 3 are available to frames 4 and 5.

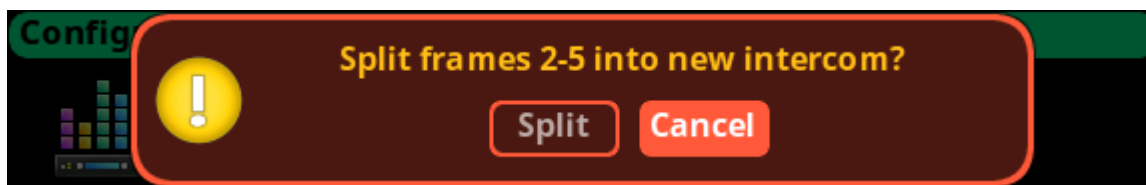

FIGURE 52. Split Frames Popup Message

---

**IMPORTANT:** Once the frame(s) are split, remove or re-cable the IFL connections.

---

To **remove a frame from the system**, do the following:

1. Select the **Split Frame icon**.  
*The Split Frame message appears.*
2. Select the **Split button**.  
*The press Home button 5 times message appears.*

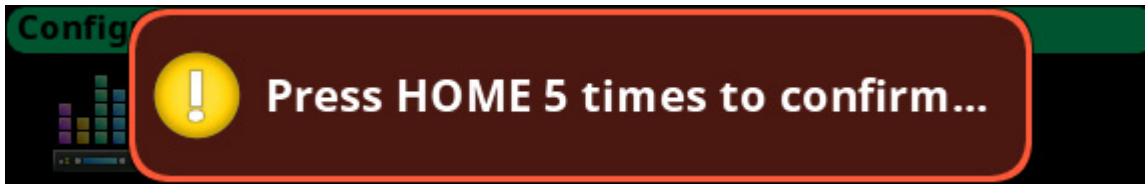

3. Press the **Home button five times**.  
*The frame reboots.*
4. Re-cable the **IFL connections** for the new intercoms created.

## Frame Mapping Table

The **Frame Mapping Table** screen is used to create the relationship between multiple frames forming one intercom and assigning the frame number of each frame within the intercom.

 A screenshot of the 'Configuration : System : Frame Mapping Table' screen. It displays a table with two columns: 'IP Address' and 'MAC Address'. The table lists five frames. The first four frames are in blue text, and the fifth frame is in gray text.
 

	IP Address	MAC Address
Frame 1:	192.168.3.28	00:1c:44:0b:a0:2e
Frame 2:	192.168.3.29	00:1c:44:0b:a0:2a
Frame 3:	192.168.3.32	00:1c:44:0b:a0:39
Frame 4:	192.168.3.39	00:1c:44:0b:a0:1f
Frame 5:	192.168.0.4	00:1c:44:0b:a0:11

FIGURE 53. Configuration | System | Frame Mapping Table

**NOTE:** The current frame is shown in gray and the IP address and MAC address of the frame cannot be modified. Only existing frames in blue can be modified. If entering IP addresses and MAC addresses in empty fields on this screen acts as a placeholder only for other frames planned for the system. It does not configure system to add them.

### Frame Field

The **Frame** field is used to select the frame to be viewed.

### IP Address Field

The **IP Address** field is used to enter the IP address of the frame's Control Port.

**NOTE:** The IP and MAC Addresses for the **current** frame cannot be edited.

### MAC Address Field

The **MAC Address** field is used to enter the MAC Address of the frame's Control Port.



## Port Allocation Table

The **Port Allocation Table** is used to allocate the different types of intercom port assignments across the intercom system. Physical hardware, such as AIO and 2-wire devices, and network port devices, such as OMNEO, can be mapped to any port in the intercom.

For detailed instructions on how to allocate ports, see “Intercom Port Allocation” on page 38.

The default port allocations are:

*Ports 1 – 14 are AIO, mapped to the physical AIO connectors (J4).*

*Ports 15 & 16 are 2-Wire, mapped to the physical XLR connectors CH-A and CH-B.*

*Ports 17 and higher (if licensed) are OMNEO.*

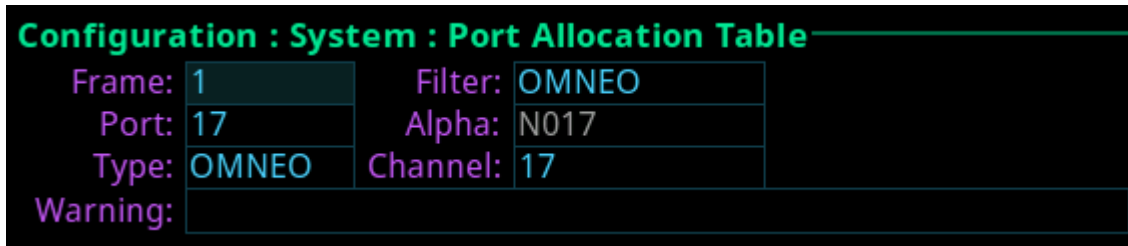

FIGURE 54. Configuration | System | Port Allocation Table

### Frame Field

The **Frame** field is used to select the frame to be viewed.

### Port Field

The **Port** field is used to select the port to configure.

### Type Field

The **Type** field is used to select the port type to configure.

Available options are *None, 2W, AIO, OMNEO, RVON*.

### Filter Field

The **Filter** field is used filter on the type of port. For example, filtering on AIO displays only AIO configured ports.

Available options are *None, 2W, AIO, OMNEO, and RVON*.

### Alpha Field

The **Alpha** field displays the Alpha assigned to the selected port.

### Channel Field

The **Channel** field is used to map AIO and 2W port instances to the physical hardware ports on the back of the frame. For instance, intercom port 5 may be assigned a port of AIO and an AIO channel 1. This means intercom port 5 must be mapped to the first AIO connector on the back of the frame.

### Warning Field

The **Warning** field displays if a port has an invalid configuration. For example, if too many AIO or 2W ports are assigned or if the same AIO or 2W channel is assigned to more than one port.

## Intercom Name

The **Intercom Name** menu is used to assign a name to the Intercom system. Intercom names can be 4-, 6-, or 8-character names, giving the user an option for name length. Intercom names can only be changed if the intercom is not connected to a Trunk Master.

---

**IMPORTANT:** The 8 Unicode field cannot be modified.

---

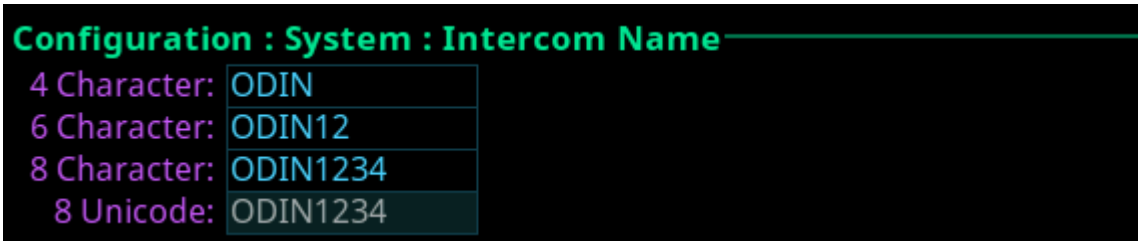

FIGURE 55. Configuration | System | Intercom Name Display

### **4 Character Field**

The **4 Character** field is used to enter a four character intercom name.

### **6 Character Field**

The **6 Character** field is used to enter a six character intercom name.

### **8 Character Field**

The **8 Character** field is used to enter an eight character intercom name.

### **8 Unicode Field**

The **8 Unicode** field displays the eight character unicode intercom name. This field is only visible if the intercom is configured to use Unicode alphas. This field cannot be edited. If the unicode name is the same as the 8 character name, any changes to the 8 Character field ripple down to this field.

## Network Menu

The **Network** menu is used to select the network interface to configure. Each network interface can be configured on its own network for security or isolation purposes.

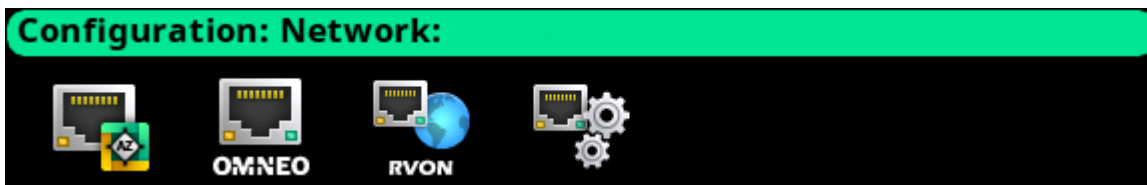

FIGURE 56. Configuration | Network Menu Icons

## Control Port

The **Control Port** is used to configure the network connection to AZedit, the connection to the Trunk Master, and for Frame to Frame communications in multi-frame systems.

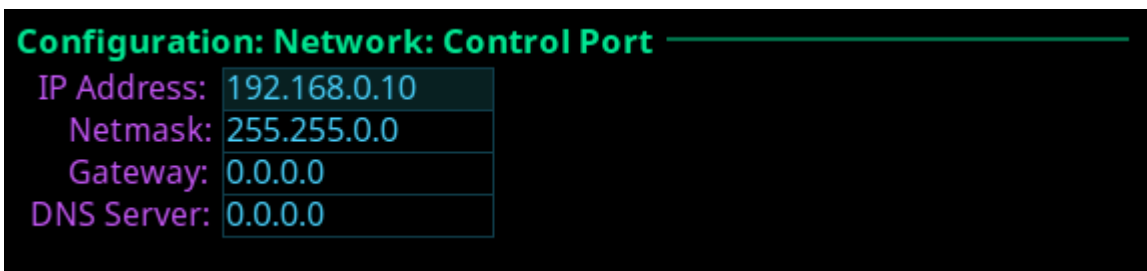

FIGURE 57. Configuration | Network | Control Port

### IP Address Field

The **IP Address** field is used to enter the IP address assigned to the Control Port interface.

### Netmask Field

The **Netmask** field is used to enter the netmask address.

### Gateway Field

The **Gateway** field is used to enter the gateway address, if applicable.

### DNS Server Field

The **DNS Server** field is used to enter the DNS server IP address, if applicable.

## OMNEO

The **OMNEO** screen is used to configure the OMNEO network interface.

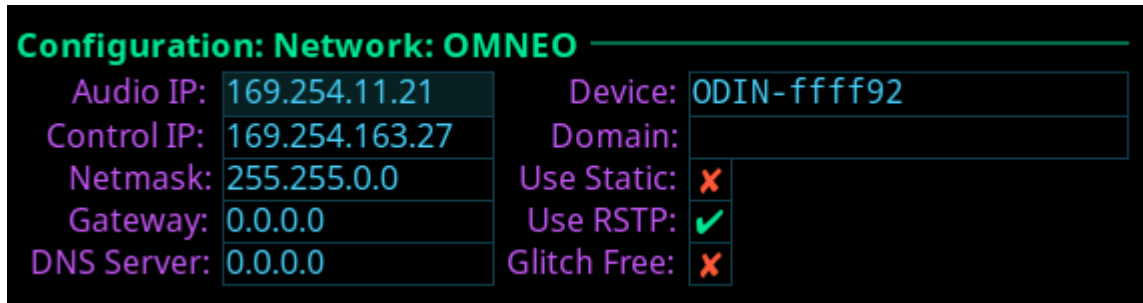

FIGURE 58. Configuration | Network | OMNEO

### Audio IP Field

The **Audio IP** field is used to enter the IP Address used to transmit and receive audio across the network.

By default, OMNEO interfaces use link local range addresses and are DHCP enabled. If there is a DHCP server on the network, it takes an IP Address from the DHCP Server. The controller and the audio device are tightly coupled and must be in the same subnet. Failure to communicate between the controller and the audio device may cause unexpected results.

### Control IP Field

The **Control IP** field is used to enter the IP address used by the OMNEO Control interface to access the network. The Controller is used to set up audio connections between two OMNEO configured ports. This address must be in the same subnet as the Audio IP.

By default, OMNEO interfaces use link local range addresses and are DHCP enabled. If there is a DHCP server on the network, it takes an IP address from the DHCP server.

The controller and the audio device are tightly coupled. Failure to communicate between the controller and the audio device may cause unexpected results.

### Netmask Field

The **Netmask** field is used to enter the netmask address.

### Gateway Field

The **Gateway** field is used to enter the gateway address, if applicable.

### DNS Server Field

The **DNS Server** field is used to enter the DNS server address for the OMNEO interface.

### Device Field

The **Device** field is used to enter the name of the ODIN frame used by other OMNEO devices.

### Domain Field

The **Domain** field is used to enter the domain in which OMNEO resides. If multiple domains are not being used, it is best to leave this field blank, which implies the .local domain is used.

**NOTE:** The DNS server address must be entered when providing a domain.

### Use Static Check Box

The **Use Static** check box determines whether the IP address for the OMNEO interface is fixed and manually entered.

## Use RSTP Check Box

The **Use RSTP** check box is used to determine whether RSTP should be used on the port. For more information, see “RSTP” on page 50.

## RVON

The **RVON** screen is used to configure the RVON network interface.



FIGURE 59. Configuration | Network | RVON

### IP Address Field

The **IP Address** field is used to enter the IP address of the RVON Port interface.

**NOTE:** The RVON Port can be on a different network from the OMNEO and Control Port interfaces.

### Netmask Field

The **Netmask** field is used to enter the netmask address.

### Gateway Field

The **Gateway** field is used to enter a gateway address, if applicable.

## Management Port

The **Management Port** is used to configure the Management Port interface located on the front of frame. The Management Port is used by a laptop running AZedit to access ODIN from the front panel connector.

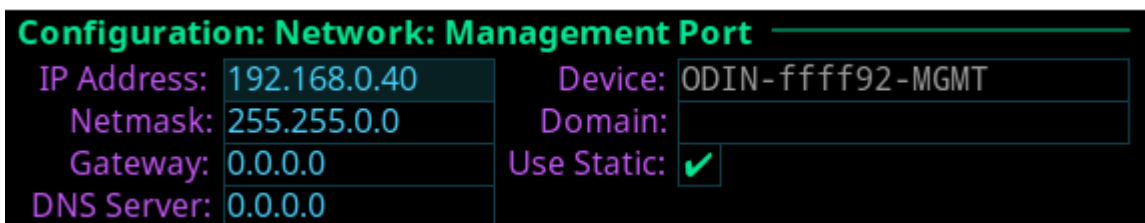

FIGURE 60. Configuration | Network | Management Port

### IP Address Field

The **IP Address** field is used to enter the IP address of the Management Port interface.

**NOTE:** The Management Port can be on a different network from the OMNEO, RVON, and Control Port interfaces.

### Netmask Field

The **Netmask** field is used to enter the netmask address.

### Gateway Field

The **Gateway** field is used to enter a gateway address, if applicable.

## DNS Server Field

The **DNS Server** field is used to enter the IP address of the DNS server.

## Device Field

The **Device** field is automatically set when the OMNEO device name is set (-MGMT is appended for the Management Port device name).

This field is not editable.

## Domain Field

The **Domain** field is used to enter the domain in which OMNEO resides. If multiple domains are not being used, it is best to leave this field blank, which implies the .local domain is used.

**NOTE:** The DNS server address must be entered when providing a domain.

## Use Static Check Box

The **Use Static** check box determines whether the IP address for the OMNEO interface is fixed and manually entered.

## Ports Menu

The **Ports** menu is used to select the port type to configure.



FIGURE 61. Configuration | Ports Menu Icons

## OMNEO Channels



FIGURE 62. Configuration | Ports | OMNEO Channels

## Frame Field

The **Frame** field is used to select the frame to be viewed.

## Port Field

The **Port** field is used to select which port to configure.

## Device Name Field

The **Device Name** field is used to enter the name of an OMNEO device to which this port attempts to connect.

### IP Address Field

The **IP Address** field displays the IP address of the device specified in the Device Name field.

### Device Type Field

The **Device Type** field is used to select the type of device to which this port attempts to connect.

### Rx Latency Selection Field

The **Rx Latency** selection field is used to set the latency threshold of the receive audio. This means how much received audio can be stored in a buffer which allows for delays in audio to be non-existent.

Available options for this field is *1 ms, 2 ms, 5 ms, 10 ms, 15 ms, and 20 ms*.

The default value for this field is *1 ms*.

### Channel Field

The **Channel** field is used to select the channel on the partner device to which this port attempts to connect.

### Description Field

The **Description** field displays the description of the port.

## RVON Channels

Configuration: Ports: RVON Channels			
Frame:	1	Port:	ITAL (N012)
IP Address:	189.22.5.2	Codec:	G.711 $\mu$
Device Type:	RVON-KP	Packet Size:	10 ms
Channel:	1	VAD:	-40 dBm
Description:			

FIGURE 63. Configuration | Ports | RVON Channels

### Frame Field

The **Frame** field is used to select the frame to be viewed.

### Port Field

The **Port** field is used to select the port alpha for the RVON port.

### IP Address Field

The **IP Address** field is used to enter the IP address of the RVON device to which this port should connect.

### Codec Field

The **Codec** field is used to select the codec type for the RVON port.

Available options for this field is *G.711a, G.711 $\mu$ , G.722, and G.729A*.

### Device Type Field

The **Device Type** field is used to select the type of RVON device connected to the port.

### Packet Size Field

The **Packet Size** field is used to select the size of each audio packet. The packet size depends on the codec selected.

Available options for *G.711a*, *G.711μ*, *G.722 – 10ms, 20ms, and 30ms*; *G.729A – 10ms, 20ms, 40ms, and 60ms*.

### Channel Field

The **Channel** field is used to select the channel number on the device to which this port is connected.

### VAD Field

The **VAD** field is used to select the threshold at which point audio is transmitted across the network.

The range for this field is *-60dBm to -30 dBm, or Off*.

### Description Field

The **Description** field is used to enter a description for the channel.

## 2-Wire Ports

2W	Port	Mode	-Auto-Mute-
CH A	N015	RTS 1	✓
CH B	N016	Off	✓

FIGURE 64. Configuration | Ports | 2-Wire Ports

### Frame Field

The **Frame** field is used to select the frame to be viewed.

### 2W Field

The **2W** field displays the two 2-Wire channels (CH A and CH B)

### Port Field

The **Port** field displays the port and alpha assigned to the 2W channel, if any.

This field is not editable.

**NOTE:** Use the “Port Allocation Table” on page 125 to reconfigure a 2W channel to a different intercom port.



## Mode Field

The **Mode** field is used to select the channel operation mode.

Available options are:

*Off*

*Audiocom* – Balanced Audio, shared power and audio

*Clear-Com* – Unbalanced, separate power and audio

*RTS1* – CH 1 Unbalanced, shared power and audio

*RTS2* – CH 2 Unbalanced, shared power and audio

Balanced and unbalanced refer to the type of audio signal being used

*Unbalanced Audio* – uses ground reference signalling

*Balanced Audio* – uses differential mode signalling

By default, this field is set to *Off*.

## Auto-Mute Field

The **Auto-Mute** field determines whether the 2W port is automatically muted. If the setting is enabled, the 2W port is muted whenever ODIN detects the absence of DC power on the line (typically because the cable on the 2W port was removed).

By default, the *Auto-Mute* is enabled.

## Peripherals Menu



FIGURE 65. Configuration | Peripherals Menu Icons

## Trunk Master

The RTS Trunking System manages communications between separate intercoms using trunks (reserved intercom ports) and connected between the intercom system. Keypanel or other data devices can communicate with various destinations in other intercom systems via trunks.

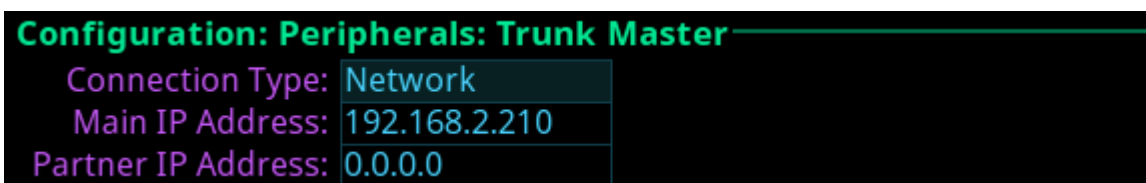

FIGURE 66. Configuration | Peripherals | Trunk Master

## Connection Type Field

The **Connection Type** field is used to select the type of connection the Trunk Master uses.

Available options are *Network* and *Disabled*.

**NOTE:** ODIN does not support a serial connection to the Trunk Master.

## Main IP Address Field

The **Main IP Address** field is used to enter the IP address of the main Trunk Master.

## Partner IP Address Field

The **Partner IP Address** field is used to enter the IP address of a standby Trunk Master, if applicable.

## GPIO-16

The **GPIO-16** screen is used to configure the GPIO-16 devices connected to the Control Port. Each GPIO-16 interface provides 16 opto-isolated inputs and 16 relay outputs. The GPI inputs can be set up to remotely control keypanel keys to activate intercom ports, party lines, and relay outputs within the intercom system. The relay outputs are assigned for activation from keypanel keys. They can be used to control lighting or to key remote transmitters, and paging systems. Relays can be assigned to keys via the AZedit intercom configuration software.

The GPIO-16 supports two (2) communication modes: *RS-485 Serial* and *Ethernet*.

For more information, see the GPIO-16 Technical Manual at [www.rtsintercoms.com](http://www.rtsintercoms.com).

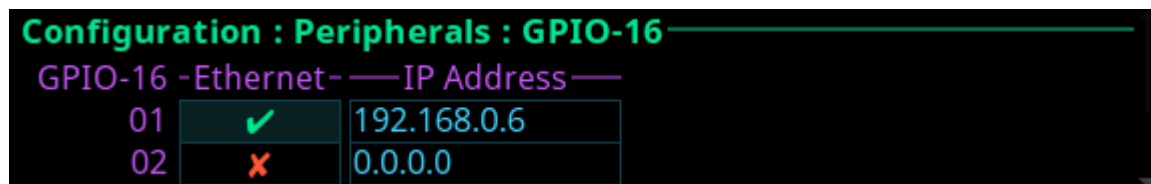

FIGURE 67. Configuration | Peripherals | GPIO-16

## GPIO-16 Field

The **GPIO-16** field displays the number of GPIO-16 devices supported by the intercom. Depending on the number GPI In/GPI Outs allocated on the Intercom Resources screen (see “Adding a frame or multiple frames is only possible from the last frame in the intercom. Removing a frame (or frames) is only possible from a frame that is not the last frame in the intercom.” on page 115), determines the number of GPIO-16 devices that shown.

## Ethernet Check Box

The **Ethernet** check box determines whether Ethernet is being used.

<input checked="" type="checkbox"/>	An Ethernet connection is enabled.
<input type="checkbox"/>	A RS-485 Serial connection is enabled.

**IMPORTANT:** When using an RS-485 serial connection, make sure the RS-485 cable is plugged into the PAP/LCP/GPIO-16 connector on the back panel.  
When using Ethernet, the Ethernet cable must be connected to the Control Port via a switch.  
When using a serial connection, a polling address for the GPIO-16 must be configured so that multiple units can be connected on the same data bus, and so the intercom knows which GPIO-16 it is.

## IP Address Field

The **IP Address** field is used to enter the IP address of the corresponding GPIO-16 device. An IP address is only needed if using an Ethernet connection.

## Authentication Menu

**Authentication** is the process of determining whether someone is who they declare to be. Authentication is commonly done through user profiles and passwords. Intercom supporting authentication may require a username and password for each AZedit session.

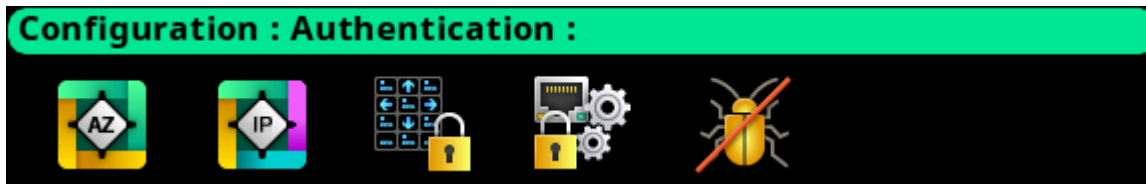

FIGURE 68. Configuration | Authentication Menu

### AZedit

The **AZedit Authentication** screen is used to define whether or not authentication for AZedit is required on any of the ports on ODIN. Up to 20 different user profiles can be created for different port authentication rules through the use of user names, passwords, admin rights, or restriction profiles required.

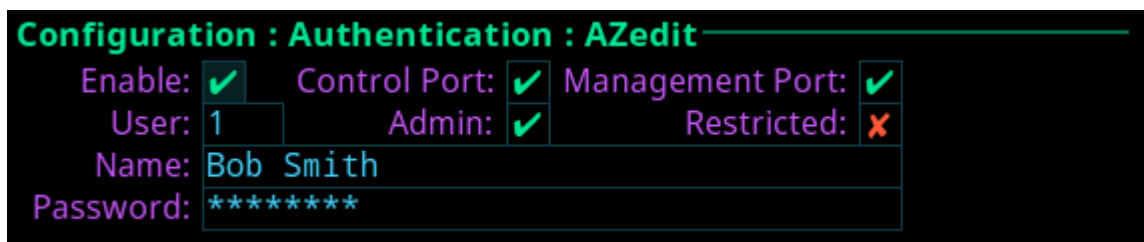

FIGURE 69. Configuration | Authentication | AZedit

#### Enable Check Box

The **Enable** check box determines whether AZedit authentication is needed on selected ports. The Enable check box must be selected to enable authentication for AZedit on any of these ports.

---

**IMPORTANT:** If authentication is enabled on all ports and no users are defined, it is possible to become locked out of the intercom system. If this occurs, contact technical support for instructions on authentication bypass to gain access to the front panel where changes to the authentication settings can be made.

---

#### Control Port Check Box

The **Control Port** check box determines whether authentication is needed when there are AZedit sessions on the port.

#### Management Port Check Box

The **Management Port** check box determines whether authentication is needed when there are AZedit sessions on the port.

#### User Field

The **User** field is used to select which user profile to view and modify.

Up to 20 user profiles can be created.

## Name Field

The **Name** field is used to enter the name of a user or group. For example, the name could be an individual user such as John Adams; or the name could be a group, such as “comms”, where a group of users can use the same profile.

## Password Field

The **Password** field is used to enter a password for logging in to the specified ports. This field is optional.

## Admin Check Box

The **Admin** check box determines whether or not the user profile has administrative rights.

## Restricted Check Box

The **Restricted** check box determines whether or not the user needs a restrictions file present to log in.

## IPedit

The **IPedit Authentication** screen is used to define the access privileges (read, write or admin) for each user profile defined. When the Write and Admin check boxes both display red Xs, Read privilege is applied.

Up to *five user profiles* can be created in the authentication table.

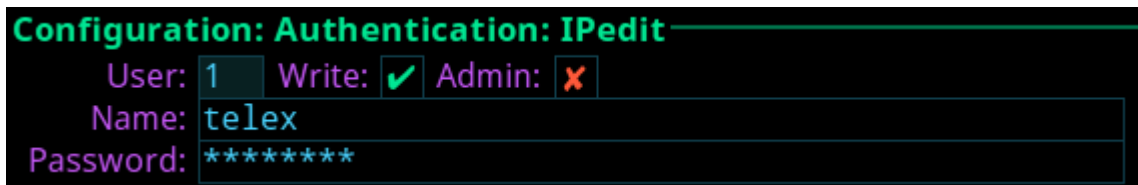

FIGURE 70. Configuration | Authentication | IPedit

## User Field

The **User** field is used to select which user profile to view and modify.

## Write Check Box

The **Write** check box determines whether or not the user profile has Write privileges.

## Admin Check Box

The **Admin** check box determines whether or not the user profile has administrative rights.

## Name Field

The **Name** field is used to enter the name of a user or group. For example, the name could be an individual user such as John Adams; or the name could be a group, such as *comms*, where a group of users can use the same profile.

## Password Field

The **Password** field is used to enter a password used to log into IPedit with the defined user profile.

This field is optional.

## Front Panel

The **Front Panel** screen is used to configure different access areas on ODIN, such as Front Panel access, Status menu access, Setup menu access, and Configuration menu access.

**IMPORTANT:** PINs are hierarchical. Whenever a PIN is entered, access to the highest level of PIN entered is granted. If all three PINs are set, front panel access is PIN protected because a Status PIN is defined. However, if the Setup PIN is set, access to Status is granted, but access to the Configuration menu is not. If the user knows the Config PIN full access is granted.



FIGURE 71. Configuration | Authentication | Front Panel

**IMPORTANT:** If the a PIN is set, and then forgotten go to AZedit | Options | ODIN Front Panel to reset the PIN.

### Access Field

The **Access** field is used to set level of security for the ODIN front panel.

Available options are:

<i>Unrestricted</i>	The front panel has full access without any restrictions.
<i>Read Only</i>	The front panel is read only. No modifications can be made to any menu items.
<i>Authenticated</i>	The user must enter a PIN to access the front panel.
<i>Disabled</i>	The front panel has no access.

### Timeout Field

The **Timeout** field is used to set the amount of time the front panel is idle before the user must re-enter a PIN when access is set to authenticated and a PIN is set.

**NOTE:** The front panel can be forced to logout (or forget a PIN has been entered) by manually activating the screen saver. This is done by pressing and holding the left shaft encoder button.

Available options are *1 minute to 15 minutes*.

### Status PIN Field

The **Status PIN** field is used to enter a numeric PIN used to access the Status menu. If a Status PIN is set, the user must enter the PIN to access any area on the front panel (for example, the Alarms menu is inaccessible without a PIN).

This field can contain *up to 20 digits*.

## Setup PIN Field

The **Setup PIN** field is used to enter a numeric PIN used to access the Intercom Setup menu.

This field can contain *up to 20 digits*.

## Config PIN Field

The **Config PIN** field is used to enter a numeric PIN used to access the Configuration menu.

This field can contain *up to 20 digits*.

## Management Port

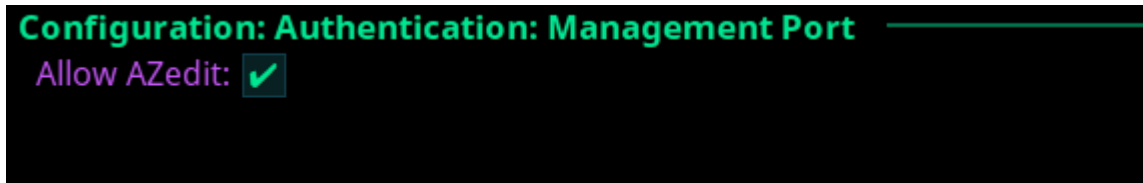

FIGURE 72. Configuration | Authentication | Management Port

## Allow AZedit Check Box

The **Allow AZedit** check box determines whether AZedit connections are allowed via the Management Port.

## Debug Shell

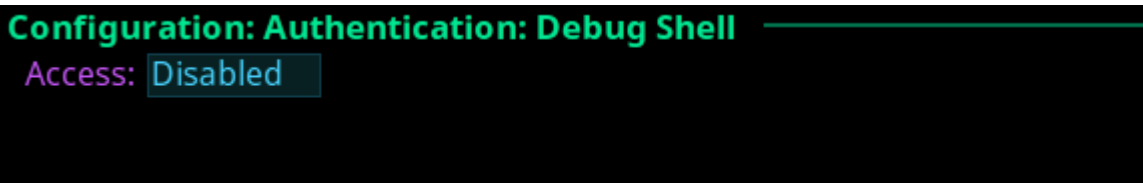

FIGURE 73. Configuration | Authentication | Debug Shell

## Access Field

The **Access** field is used to grant access to the debug shell and enable serial telnet on ODIN.

Telnet is available on the Control Port only.

Available options are *Enabled* and *Disabled*.

## User Interface Menu

The **User Interface** menu is used to configure different user display options on the frame.



FIGURE 74. Configuration | User Interface Menu

### LCD Brightness

The **LCD Brightness** screen is used to set the brightness of the front display.

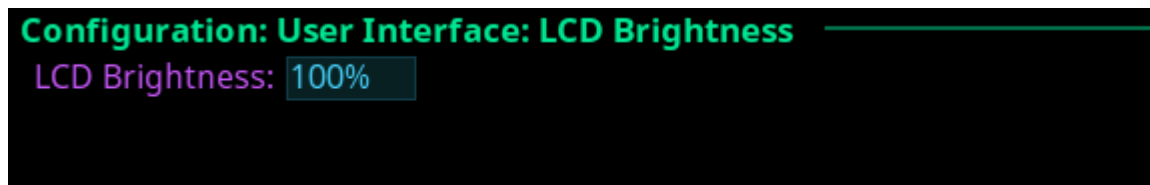

FIGURE 75. Configuration | User Interface | LCD Brightness

### LCD Brightness Selection Field

The **LCD Brightness** selection field is used to set the front panel display brightness.

The range for this field is 35% to 100%.

### Screen Saver

The **Screen Saver** screen is used to configure the way the screen saver operates.

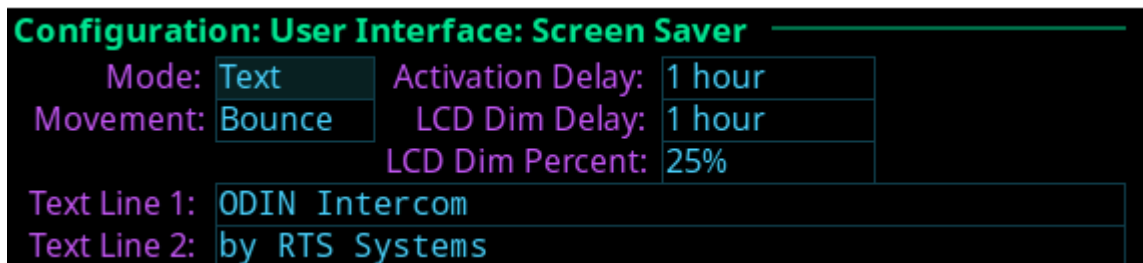

FIGURE 76. Configuration | User Interface | Screen Saver

### Mode Field

The **Mode** field is used to select the type of screen saver desired.

Available options are *Bitmap*, *Text*, or *Blank*.

### **Movement Field**

The **Movement** field is used to select the type of movement the screen saver is to perform.

Available options are *Bounce* or *Scroll*.

### **Activation Delay Field**

The **Activation Delay** field is used to set the amount of time before the screen saver starts.

Available options for this field are *Disabled*, *12 hours*, *10 hours*, *8 hours*, *6 hours*, *4 hours*, *2 hours*, *1 hour*, and *30 minutes*.

### **LCD Dim Delay Field**

The **LCD Dim Delay** field is used to set the amount of time before the LCD dims.

Available options for this field are *Disabled*, *12 hours*, *10 hours*, *8 hours*, *6 hours*, *4 hours*, *2 hours*, *1 hour*, and *30 minutes*.

### **LCD Dim Percent Field**

The **LCD Dim Percent** field is used to set the brightness of the panel display when the LCD dims, from 0 to 100%. This setting is a percentage of the current LCD brightness. For example, if the backlight is configured for 60%, then in this menu, 100% is equal to 60% and 0% is equal to 35%.

### **Alpha Size**

The **Alphas** screen is used to configure the alpha size (length) shown when alphas are displayed on the front panel.

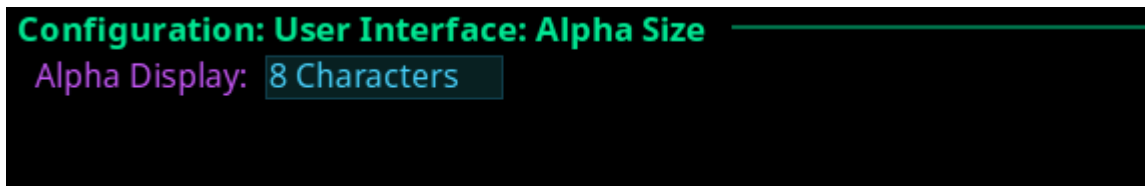

FIGURE 77. Configuration | User Interface | Alpha Size

### **Alpha Size Field**

The **Alpha Size** field is used to select the size of alphas displayed on the front panel.

Available sizes are *4 Characters*, *6 Characters*, *8 Characters*, and *8 Unicode*.



## Keypad

The **Keypad** screen is used to configure how and when the keypad backlight activates and the color and brightness of the keypad backlight LEDs display in each keypad mode.



FIGURE 78. Configuration | User Interface | Keypad

### Backlight Mode Field

The **Backlight Mode** field is used to select how and when the keypad backlight activates.

Available options are:

- Activated (swallow first keypress)* The first keypad key pushed when the keypad is Inactive is only used to activate the keypad, the actual keypad key push event is not acted upon.
- Activated (process first keypress)* The first keypad key pushed when the keypad is Inactive, activates the keypad and is processed.
- Always Active* The keypad backlight is always in the active state.
- Always Inactive* The keypad backlight is always in the inactive state. When selected, the LED color/brightness does not change when SHIFT is pressed, even if the keypanel is in SHIFT mode.

**NOTE:** When the front panel menu is not active, the backlight stays lit for 5 seconds of inactivity before returning to the inactive state. However, when the front panel menu is active, the backlight stays lit for one minute before exiting the menu system and returning to the inactive state.

### Inactive State LED Color Field

The **Inactive State LED Color** field is used to select the LED backlight color when the keypad is in the inactive state.

Available options are *Blue* and *White*.

### Active State LED Color Field

The **Active State LED Color** field is used to select the LED backlight color when the keypad is in the active state.

Available options are *Blue* and *White*.

### Shift State LED Color Field

The **Shift State LED Color** field is used to select the LED backlight color when the keypad is in the Shift state.

Available options are *Blue* and *White*.

### LED Brightness Field

The **LED Brightness** field is used to set the brightness of the keypad backlight LEDs.

Brightness ranges from 0% to 100%.

By default, brightness is set for 30% for the Inactive state; and 100% for the Active and Shift states.

## Options

The **Options** screen is used to configure advanced user interface options.

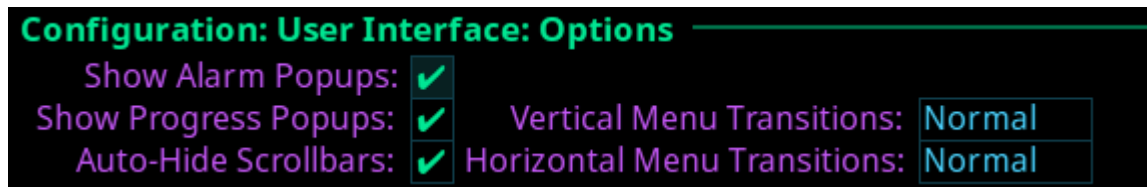

FIGURE 79. Configuration | User Interface | Options

### Show Alarm Popups Check Box

The **Show Alarm Popups** check box determines whether or not popup messages display when an alarm is triggered.

By default, *Show Alarm Popups* is enabled.

### Show Progress Popups Check Box

The **Show Progress Popups** check box determines whether or not progress bars are displayed on the front panel when writing new firmware, fonts, or resources to the intercom.

By default, *Show Progress Popups* is enabled.

### Auto-Hide Scroll Bars Check Box

The **Auto-Hide Scroll Bars** check box determines whether or not a scroll bar located on the right side of some screens auto-hides after a few seconds or if it is always visible.

---

**IMPORTANT:** Not all screens have scroll bars. Only screens with more information than can fit on one display have the scroll bar capability.

---

By default, *Auto-Hide Scroll Bars* is enabled.

### Vertical Menu Transitions Field

The **Vertical Menu Transitions** field is used to set the speed of or disable the vertical menu transitions. Vertical menu navigation, or sibling menu navigation, is used to navigate a menu structure by moving between branches of the menu without having to go up one level and then back down again. For example, if the menu structure is at the top level Configuration menu screen, turning the left encoder knob to the right one notch moves the menu structure to the top level Intercom Setup menu.

If the focus of the menu is within a top level menu structure, turning the left encoder knob to the right one notch moves the menu structure to the next menu item within the same top level menu. For example, if the menu focus is at Configuration | Network, turning the left encoder knob to the right one notch moves the menu structure to Configuration | Ports.

Available options for this field are:

- Disabled* No vertical transitions allowed.
- None* No transition animation is seen. Navigation is seen as jumps.
- Normal* The entire menu rolls up and down smoothly to reveal a new sibling.
- Fast* The entire menu rolls up and down faster than normal; however, it may not be as smooth.

The default for this field is *Normal*.

## Horizontal Menu Transitions Field

The **Horizontal Menu Transitions** field is used to set the speed of horizontal transitions within a menu. Horizontal menu transitions are movements within a menu structure to the next / previous menu item using the right encoder to navigate.

Available options for this field are:

- None* No transition animation is seen. Navigation is seen as jumps. The purple focus frame jumps to a new menu item.
- Normal* The purple focus frame smoothly slides horizontally from icon to icon.
- Fast* The purple focus frame slides horizontally from icon to icon faster than normal; however, it may not be as smooth.

The default for this field is *Normal*.

## Advanced Menu

The **Advanced** menu is used to configure more advanced options on the frame.



FIGURE 80. Configuration | Advanced Menu Icons

## DHCP Server

The **DHCP Server** screen is used to enable and configure **DHCP** (Dynamic Host Configuration Protocol) server settings for the selected frame.

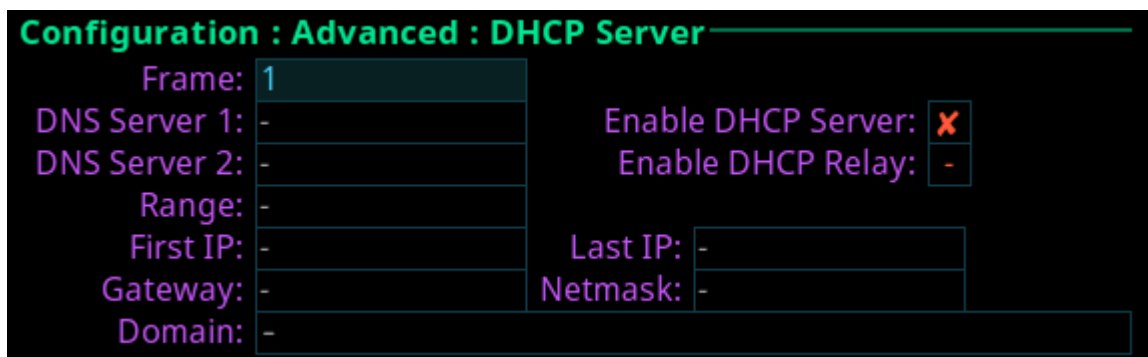

FIGURE 81. Configuration | Advanced | DHCP Server

### Frame Field

The **Frame** field is used to select the frame to be viewed.

### DNS Server 1 Field

The **DNS Server 1** field is used to enter the IP address of the DNS server.

### DNS Server 2 Field

The **DNS Server 2** field is used to enter the IP address of a second DNS server, if needed.

### Enable DHCP Server Check Box

The **Enable DHCP Server** check box is used to enable DHCP server functionality.

### Enable DHCP Relay Check Box

The **Enable DHCP Relay** check box is used to enable the DHCP server to provide addresses to devices outside of its own subnet.

### Range Field

The **Range** field is used to select which range to view and edit. The DHCP Server supports up to eight ranges of IP addresses.

### First IP Field

The **First IP** field is used to enter the first IP address in the range being defined.

### Last IP Field

The **Last IP** field is used to enter the last IP address in the range being defined.

### Gateway Field

The **Gateway** field is used to enter the gateway address used by the devices defined in this range.

### Netmask Field

The **Netmask** field is used to enter the netmask address used by the devices defined in this range.

### Domain Field

The **Domain** field is used to enter the domain name used by the devices defined in this range.

## SNMP

The **SNMP** configuration screen is used to configure SNMP (Simple Network Management Protocol) for the intercom system. SNMP sends notifications when specified events occur within the intercom.

System Info		Community Strings	
Name:		Read-Only:	public
Location:		Read-Write:	
Contact:		Traps:	trap
Use Hosts:	X	Target 1:	0.0.0.0
Host 1:	0.0.0.0	Target 2:	0.0.0.0
Host 2:	0.0.0.0	Target 3:	0.0.0.0
Host 3:	0.0.0.0	Target 4:	0.0.0.0
Host 4:	0.0.0.0	Target 5:	0.0.0.0
Host 5:	0.0.0.0		

FIGURE 82. Configuration | Advanced | SNMP

### System Info

**System information** is used for documentation purposes. This information is used to see which device is configured and where it is physically located.

---

### Name Field

The **Name** field is used to enter the name of the Intercom System in which SNMP is configured.

This field can contain *up to 255 characters*.

### Location Field

The **Location** field is used to enter the physical location of the intercom system (for example, 3rd floor, New York).

This field can contain *up to 255 characters*.

### Contact Field

The **Contact** field is used to enter the name of person responsible for the specified SNMP device.

This field can contain *up to 255 characters*.

### Use Hosts Check Box

The **Use Hosts** check box determines whether queries are allowed by specified SNMP monitoring devices.

If this check box is selected, then only devices included in the Hosts list are allowed to send SNMP requests to the device. If the device receives an SNMP request, and the sender's IP address does not appear in the list of hosts, then the request is silently discarded.

If the check box is not selected, then the targeted device responds to any and all SNMP requests, no matter the sender's IP address.

### Host 1 through Host 5 Field

The **Host 1** through **Host 5** fields are used to enter the IP addresses of host machines that can send SNMP requests to the intercom.

---

### Community Strings

---

**Community Strings** are used to define the level of security to use when queries are submitted. SNMP Community Strings are like passwords for network devices.

Most often, there is one community string used for read-only access to a network device. The default value for this community string is often public.

### Read-Only Field

The **Read-Only** field is used to enter the password that provides read-only access via SNMP.

This field can contain *up to 64 characters*.

The default entry is *public*.

### Read-Write Field

The **Read-Write** field is used to enter the password that provides read-write access via SNMP. If the Read-Write field is empty, SNMP is limited to read-only access.

This field can contain *up to 64 characters*.

### Traps Field

The **Traps** field is used to enter the trap identifier for the SNMP event monitor. The traps community string specifies the community string included in all SNMP traps generated by the intercom.

This field can contain *up to 64 characters*.

The default entry is *trap*.

## Target 1 through Target 5 Field

The **Target 1** through **Target 5** fields are used to enter the IP address of computers where trap messages are sent.

## Clock Select

The **Clock Select** screen is used to configure the word clock used to synchronize audio across the frames in an intercom system.

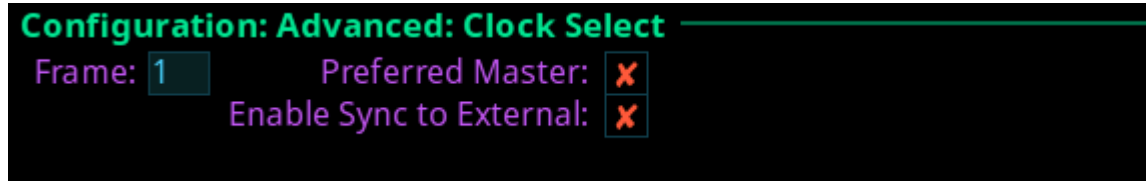

FIGURE 83. Configuration | Advanced | Clock Select

### Frame Field

The **Frame** field is used to select the frame to be viewed.

### Preferred Master Check Box

The **Preferred Master** check box determines whether the frame is configured as the preferred master clock for other OMNEO devices on the network.

### Enable Sync to External Check Box

The **Enable Sync to External** check box determines whether the intercom system synchronizes to an external word clock.

---

**IMPORTANT:** ODIN only requires a 48 kHz external word clock if the Enable Sync to External check box is selected. If a Network PTP clock is used, an external word clock is not needed.

---

## Soft Reset

A **Soft Reset** is used to reboot the frame without resetting any of the configurations.

To **perform a soft reset**, do the following.

1. Turning the right encoder knob, navigate to the **Soft Reset icon**.
2. Press the **right encoder knob**.

*The Soft Reset Confirmation message appears.*

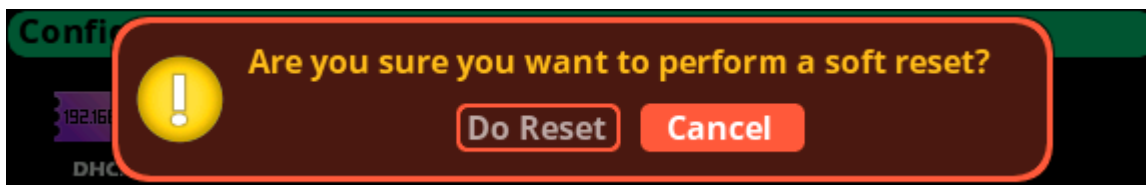

3. Turning the right encoder knob, move the **button focus to Do Reset**.
4. Press the **right shaft encoder**.  
*A countdown message gives direction to press the HOME key on the keypad 5 times.*
5. Press the **HOME key five times**.  
*ODIN reboots.*

---

## *Intercom Setup Menu*

The **Intercom Setup** menu is used to setup keypanels, intercom resources, gains and alphas.

---

**IMPORTANT:** Changes made to front panel settings are saved to flash immediately. However, changes made to Intercom Setup may not be saved for up to 5 minutes after the change is made.

---



FIGURE 84. Intercom Setup | Resources Menu Icons

---

## **Stored Setups Menu (Single Frame Only)**

**Stored Setups** are full AZedit setup files that are stored locally in ODIN and can be recalled from the front panel (or AZedit) without having to send the file from AZedit. Up to four stored setups (Slots) can be configured and saved in ODIN.

The following can be done from the Stored Setups menu:

- confirm slot validation
- save the current setup to a slot
- restore the setup from a valid slot
- delete a valid setup
- update the description of a valid setup

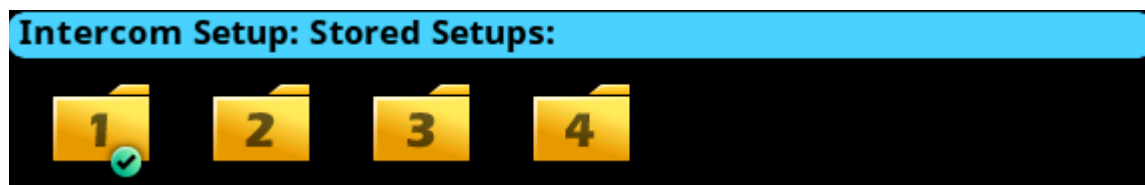

FIGURE 85. Intercom Setup | Stored Setups Menu Icons

---

**IMPORTANT:** Stored Setups are limited to use with single frame intercom systems. The Stored Setups menu item does not appear in multi-frame systems.

---

## Slot 1 through Slot 4



FIGURE 86. Intercom Setup | Stored Setups | Slot 1

### Valid Check Box

The **Valid** check box indicates whether or not there is a saved setup in the slot. If the slot is not valid, Restore, Delete and Update Description cannot be performed.

### Description Field

The **Description** field is used to enter a description of the Stored Setup (for example, “Comms Truck 1”). Use the description field to enter a detailed description for saving this setup.

This field can contain *up to 130 characters*.

### Save Button

The **Save** button is used to save the current Intercom Setup to the selected slot (Slot 1, Slot 2, Slot 3, or Slot 4). Once the Save button is selected, a message appears in the display confirming the Save Action.

### Restore Button

The **Restore** button is used to load and activate a setup file. For example, entering the Slot 3 Setup file menu option and selecting the Restore button replaces the current setup file with the Slot 3 stored setup file.

### Delete Button

The **Delete** button erases the selected Stored Setup.



## Update Description Button

The **Update Description** button is used to confirm and update the changes made to the description of the Stored Setup. Changes to the description can also be made in AZedit on the Stored Setups window (ONLINE | Stored Setups).

---

**IMPORTANT:** The contents of a stored setup from ODIN cannot be viewed. The Description field is used to describe in detail the saved setup parameters.

---

To **save a setup**, do the following:

1. Click the **Stored Setups** icon.  
*The four setup slot folders appear.*
2. Click the **slot** to store the setup file.  
*The Slot <N> screen appears.*
3. In the Description field, enter a **description** for the stored setup.
4. Click the **Save button**.  
*The Save current setup to slot <n> message appears.*



5. Click the **Proceed button**.  
*The Stored Setup menu appears. The Saved Setup Slot folder is shown with a green check mark.*

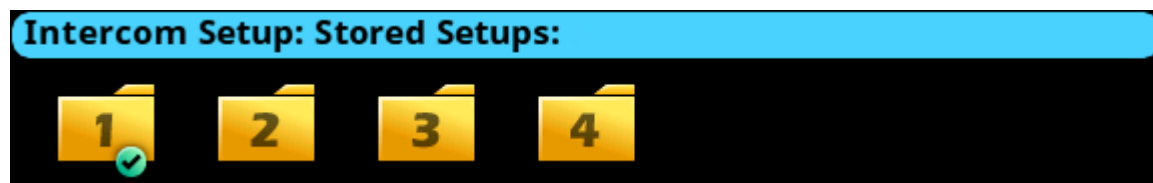

**Stored Setups Window**

The **Stored Setups** window in AZedit is used to view and verify setup files as well as update descriptions.

**NAVIGATION:** In AZedit, from the ONLINE menu, select Stored Setups.

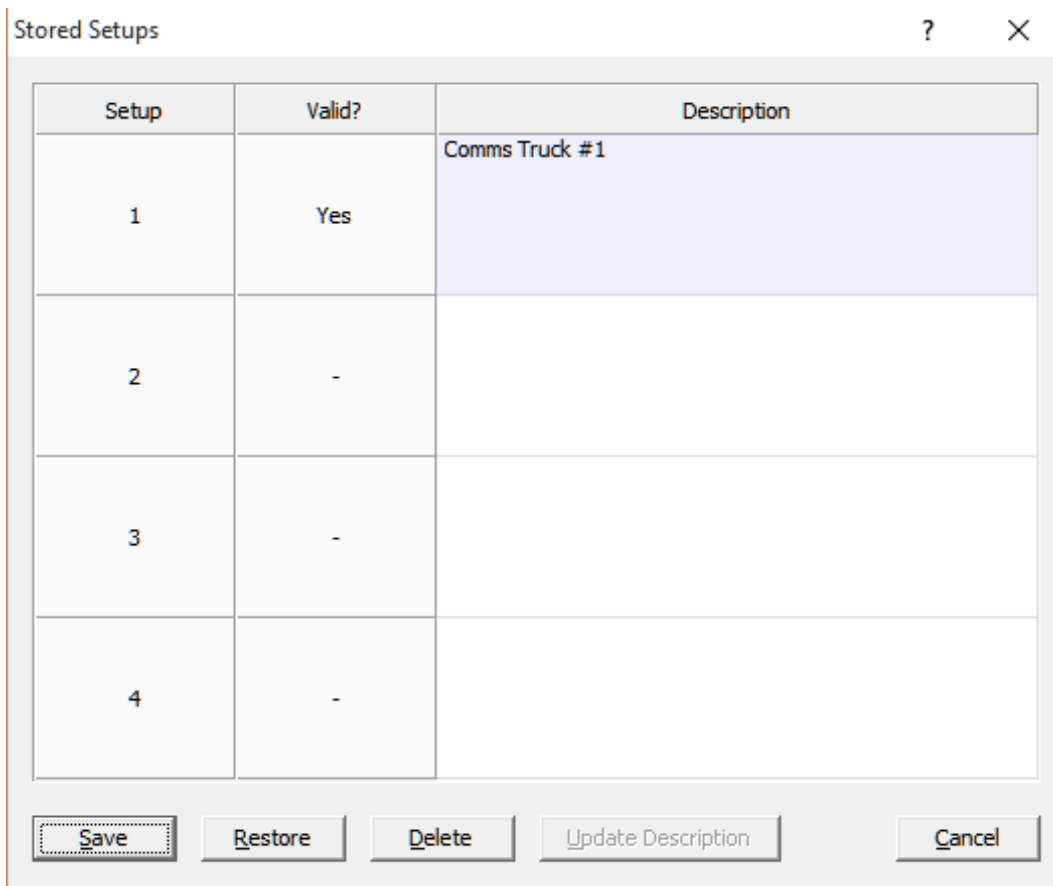

Setup	Valid?	Description
1	Yes	Comms Truck #1
2	-	
3	-	
4	-	

Buttons: Save, Restore, Delete, Update Description, Cancel

**TABLE 3.** Stored Setups Window in AZedit

**NOTE:** The Save, Restore, Delete, and Update Description buttons perform the same actions via AZedit as described for the front panel.

## Keypanels Menu

The **Keypanels** menu is used to configure keypanel assignments, key options, and setup pages in the intercom system.



FIGURE 87. Intercom Setup | Keypanels Menu Items

## Key Assignments

The **Key Assignments** screen is used to configure key assignments on keypanel keys.

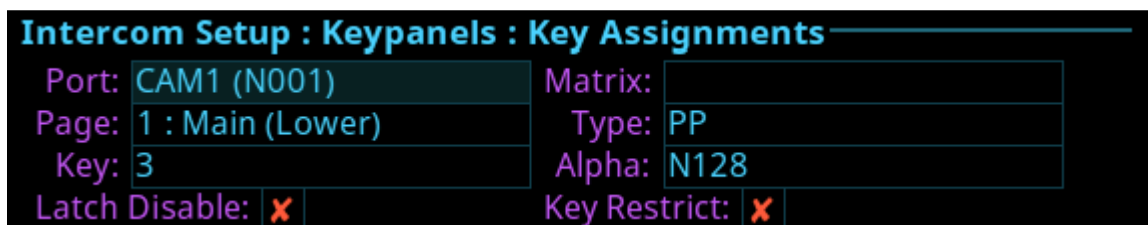

FIGURE 88. Intercom Setup | Keypanels | Key Assignments

### Port Field

The **Port** field is used to select the desired port where the key assignment is to be assigned.

### Page Field

The **Page** field is used to select the setup page where the key assignment is to be assigned

### Key Field

The **Key** field is used to select the key on the selected setup page where the key assignment is to be assigned

### Matrix Field

The **Matrix** field is used to select the matrix for the key assignment, if available. Only matrices with available scroll lists are shown.

### Type Field

The **Type** field is used to select the key assignment type.

Selections for this field can include *SPCL, PP, PL, IFB, SL, RY, ISO, UR, and IFBSL*. Only the assignment types available for the selected matrix are shown.

### Alpha Field

The **Alpha** field is used to select the desired alpha to assign to the key. The alpha selection only shows the available instances of the selected type.

## Latch Disable Check Box

The **Latch Disable** check box indicates the key cannot be latched on by the keypanel user. Clear the check box to enable latching capabilities. When Latching is enabled, the talk function stays on after the talk key is pressed briefly. Otherwise, the talk function only works when the button is pressed.

**NOTE:** A key only latches if it is pressed and released within 0.5 seconds. Otherwise, the key always turns off.

## Key Restrict Check Box

The **Key Restrict** check box indicates the keypanel key is restricted and cannot be modified by the keypanel user. Use this option to prevent keypanel user from changing the key assignment.

## Setup Pages

Setup pages are used to allow access to more key assignments than physical keys on the keypanel. This is useful for sharing a keypanel because setup pages can be used to swap between the key assignments used for each person.

Up to 15 setup pages per keypanel port can be configured.

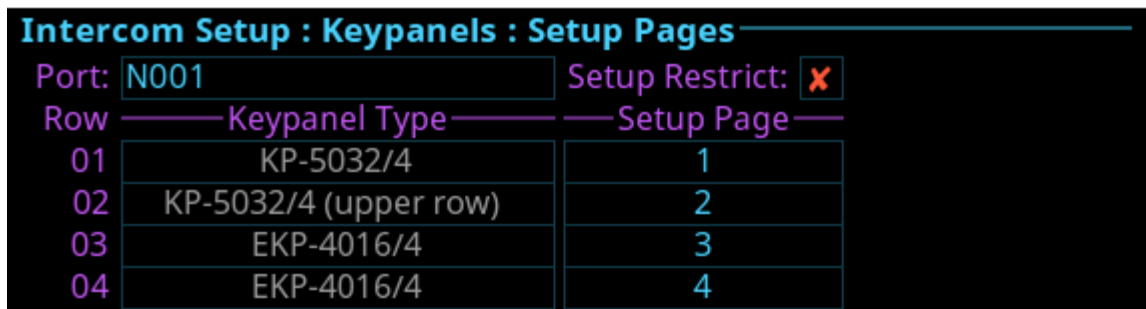

Port:	Setup Restrict:	
N001	<input checked="" type="checkbox"/>	
Row	Keypanel Type	Setup Page
01	KP-5032/4	1
02	KP-5032/4 (upper row)	2
03	EKP-4016/4	3
04	EKP-4016/4	4

FIGURE 89. Intercom Setup | Keypanels | Setup Pages

## Port Field

The **Port** field is used to select the desired port where the setup pages is assigned.

## Setup Restrict Check Box

The **Setup Restrict** check box indicates the user is restricted from changing the setup pages.

## Row Field

The **Row** field displays the number of physical keys supported divided by 16. For example, if the intercom is configured for 64 keys per port, then four rows are shown. For each row, you can select a setup page.

*64 keys = 4 rows*

*96 keys = 6 rows*

*128 keys = 8 rows*

*There can be up to 15 setup pages, depending on how many were configured in the intercom setup.*

## Keypanel Type Field

The **Keypanel Type** field identifies the type of keypanel or expansion panel being used.

## Setup Page Field

The **Setup Page** field is used to select the setup page for the selected keypanel or expansion panel.

## Scroll Enables

The **Scroll Enables** screen is used to configure selected ports for scroll enable and/or latch disable.

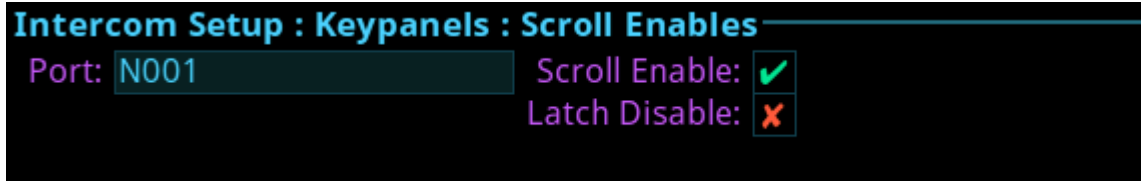

FIGURE 90. Intercom Setup | Keypanels | Scroll Enables

### Port Field

The **Port** field is used to select the desired port where scroll enable and latch disable is to be enabled or disabled.

### Scroll Enable Check Box

The **Scroll Enable** check box determines whether the selected port is visible in scroll lists.

### Latch Disable Check Box

The **Latch Disable** check box determines whether the selected keypanel, when assigned to a key, causes the key to become latch disabled. This can be overridden by clearing the latch disable for the key after the assignment is made.

## Resources Menu

The **Resources** menu is used to setup intercom resources in the intercom.

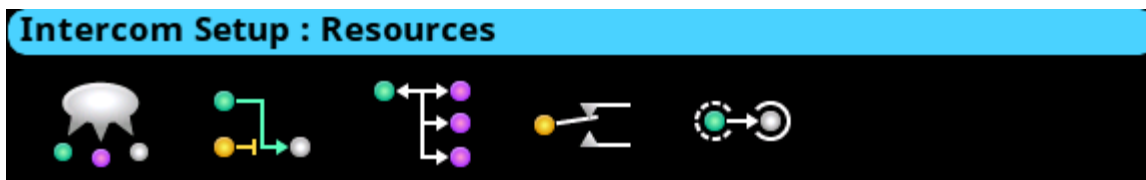

FIGURE 91. Intercom Setup | Resources Menu Icons

## Party Line

The **Party Line** screen is used to configure Party Line membership and options.

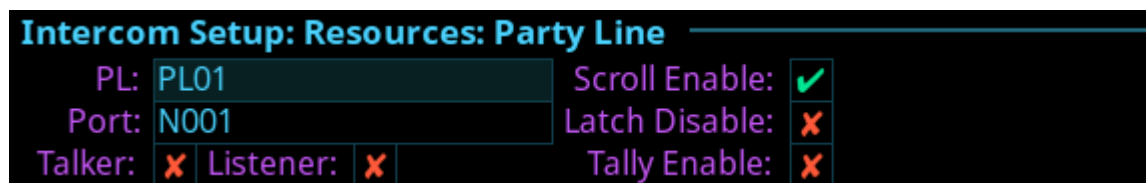

FIGURE 92. Intercom Setup | Resources | Party Line

### PL Field

The **PL field** is used to select the party line to configure.

## Port Field

The **Port** field is used to select the port whose party line membership is desired to view or modify.

## Talker Check Box

The **Talker** check box designates the selected port as a permanent talker on the current party line. This means the port is always talking. The permanent talkers are usually only used with devices that cannot turn talk keys on and off. This option is usually not used with keypanels.

## Listener Check Box

The **Listener** check box designates the selected port as a permanent listener on the current party line assignment. This means the port is always listening. The permanent listeners are usually only used with devices that cannot turn listen keys on and off. This option is usually not used with keypanels.

## Scroll Enable Check Box

The **Scroll Enable** check box determines whether the current PL is visible in the local scroll list.

## Latch Disable Check Box

The **Latch Disable** check box determines whether the party line, when assigned to a key, causes the key to become latch disabled. This can be overridden by clearing the latch disable for the key after the assignment is made.

## Tally Enable Check Box

The **Tally Enable** check box determines whether tallies are enabled on the current party line. If tallies are enable for party lines, keypanel keys that have this party line key assignment tally when a user talks to the party line.

## IFB

The **IFB** screen is used to configure IFB definitions and options.



FIGURE 93. Intercom Setup | Resources | IFB

## IFB Field

The **IFB** field is used to select the desired IFB to configure.

## Input Field

The **Input** field is used to select the IFB program input port. The program input is always routed to the IFB output (except when the IFB is being interrupted). Program input is also referred to as Mix Minus (-).

## Output Field

The **Output** field is used to select the IFB output port. The IFB Output is the audio heard by the talent. For example, the Program Input is routed and heard as the IFB output (except when the IFB is being interrupted).

## Listen Field

The **Listen** field is used to select the listen source port. The listen source is what a keypanel operator would hear when they listen to an IFB (if the listen assignment is an AT, Auto-Table). Often, the talent's pre-fade mic is used as the listen source so the talent can always be heard by the keypanel operator.

## Scroll Enable Check Box

The **Scroll Enable** check box determines whether the current IFB is visible in the local scroll list.

## Latch Disable Check Box

The **Latch Disable** check box determines whether the IFB, when assigned to a key, causes the key to become latch disabled. This can be overridden by clearing the latch disable for the key after the assignment is made.

## Dim Field

The **Dim** field is used to select how much the program input is dimmed when the IFB is interrupted.

The range for this field is *-1.0 dB to -80 dB, and Mute*.

The default for this field is *Mute*.

## Special List

The **Special List** screen is used to configure Special List membership and options.

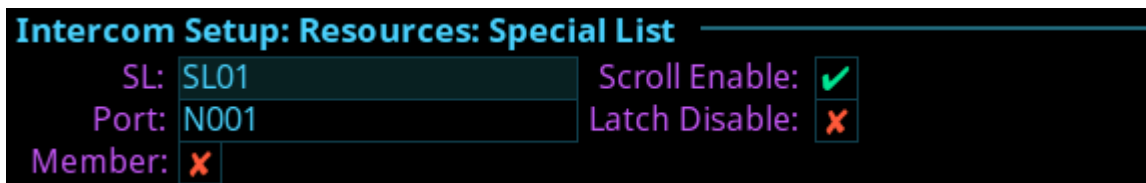

FIGURE 94. Intercom Setup | Resources | Special List

## SL Field

The **SL** is used to select the special list to configure.

## Port Field

The **Port** field is used to select the port whose SL membership to view or modify.

## Member Check Box

The **Member** check box determines whether the selected port is a member of the special list. If selected, the port belongs to a special list.

## Scroll Enable Check Box

The **Scroll Enable** check box determines whether the current SL is visible in the local scroll list.

## Latch Disable Check Box

The **Latch Disable** check box determines whether the SL, when assigned to a key, causes the key to become latch disabled. This can be overridden by clearing the latch disable for the key after the assignment is made.

## Relay

The **Relay** screen is used to configure Relay definitions and options.

For each relay, an input port and an output port must be defined. When the input port and output port crosspoint is closed, the associated relay is activated. If an input port or an output port are defined, but not both, the definition is incomplete and the relay will not be activated by crosspoint status. Relays can also be activated by UPL.

**NOTE:** If using a multiframe system, the relay connectors on the rear panel of frame #1 are GPI outputs 1-4. The relay connectors on the rear panel of frame #2 have GPI outputs 5-8, the relay connectors on the rear panel of frame #3 have GPI outputs 9-12, etc.

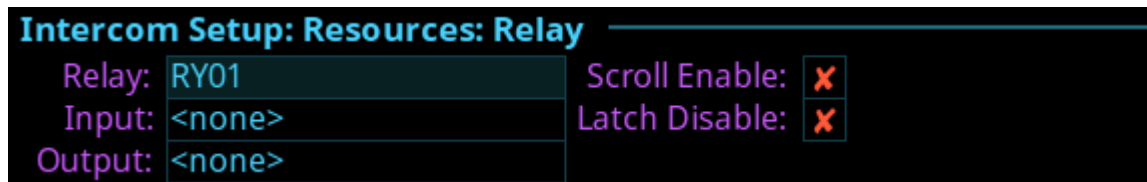

FIGURE 95. Intercom Setup | Resources | Relay

### Relay Field

The **Relay** field is used to select the relay to be configured.

### Input Field

The **Input** field is used to select the input port side of the relay being defined.

Available options are:

*<none>*

*<any>* if any crosspoint is closed to the output port, the relay will be activated.

*<port number>*

### Output Field

The **Output** field is used to select the output port side of the relay being defined.

Available options are:

*<none>*

*<port number>*

### Scroll Enable Check Box

The **Scroll Enable** check box determines whether the current relay is visible in the local scroll list.

### Latch Disable Check Box

The **Latch Disable** check box determines whether the Relay, when assigned to a key, causes the key to become latch disabled. This can be overridden by clearing the latch disable for the key after the assignment is made.



## ISO

The **ISO** (Isolate) screen is used to configure settings for ISOs in the intercom system.

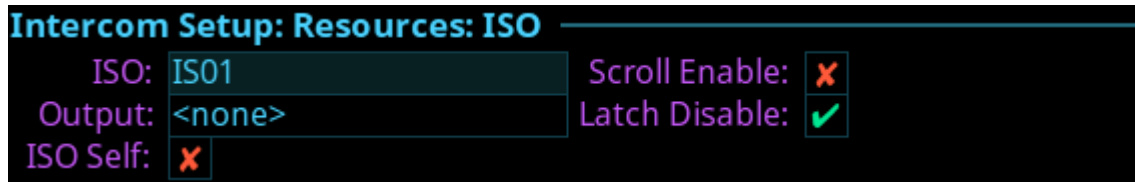

FIGURE 96. Intercom Setup | Resources | ISO

### **ISO Field**

The **ISO** field is used to select the ISO to be configured.

### **Output Field**

The **Output** field is used to enter the port number of the port to isolate when the ISO key is pressed.

### **ISO Self Check Box**

The **ISO Self** check box determines whether the ISO caller is isolated (as well as the target) so both ends only hear each other. When the ISO key is released, normal intercom operation is automatically restored.

### **Scroll Enable Check Box**

The **Scroll Enable** check box determines whether the current ISO is visible in the local scroll list.

### **Latch Disable Check Box**

The **Latch Disable** check box determines whether the ISO, when assigned to a key, causes the key to become latch disabled. This can be overridden by clearing the latch disable for the key after the assignment is made.

## Gains Menu

The **Gains** menu is used to set I/O gains, crosspoint gains, and party line gains.



FIGURE 97. Intercom Setup | Gains Menu Icons

## I/O

The **I/O** screen is used to configure input and output gains for selected ports in the intercom system. Input and output gain adjustments are used when an intercom port is interfaced to an external device operating at a different audio level than the intercom system.

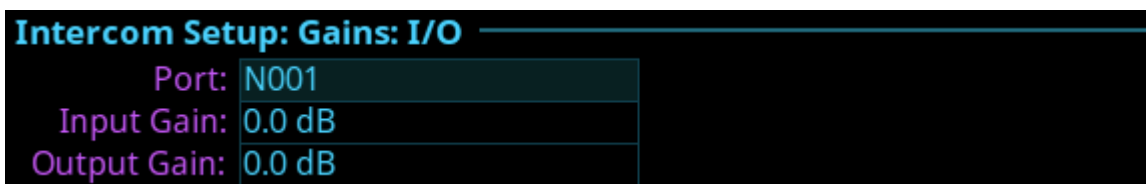

FIGURE 98. Intercom Setup | Gains | I/O

### Port Field

The **Port** field is used to select the desired port's gain to view or modify.

### Input Gain Field

The **Input Gain** field is used to set the amount of gain, in dB, applied to the selected port's input audio.

The range for this field is  $+20dB$  to  $-20dB$ .

### Output Gain Field

The **Output Gain** field is used to set the amount of gain, in dB, applied to the selected port's output audio.

The range for this field is  $+20dB$  to  $-20dB$ .

## Crosspoint

The **Crosspoint Gains** screen is used to configure individual gain levels for crosspoints within the intercom system. Crosspoint gain adjustments are used to adjust the level between two specific intercom ports.



FIGURE 99. Intercom Setup | Gains | Crosspoint

### Port Field

The **Port** field is used to select the desired output port's crosspoint listen gains to view or modify.

### Listening To Field

The **Listening To** field is used to select the input port to which the selected output port is listening.

### Crosspoint Gain Field

The **Crosspoint Gain** field is used to select the gain at which the selected port would hear the selected input port.

The range for this field is *-80dB to +6.0dB, and Mute.*

## Party Line

The **Party Line** screen is used to set the gain level for ports listening to party lines.

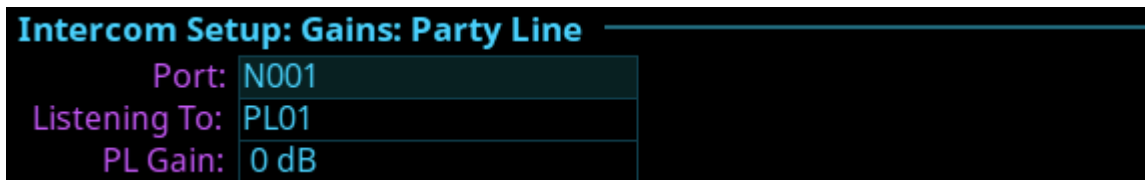

FIGURE 100. Intercom Setup | Gains | Party Line

### Port Field

The **Port** field is used to select the desired port's party line listen gains to view or modify.

### Listening To Field

The **Listening To** field is used to select the party line to which the selected port is listening.

### PL Gain Field

The **PL Gain** field is used to select the gain at which the selected port would hear the selected party line.

The range for this field is *-80dB to +6.0dB, and Mute.*

## Alphas Menu

The **Alphas** menu item is used to view and modify the alphas for key assignment resource types. The assignment types that can be configured are Ports, Party Lines, IFBs, Special Lists, Relays, and ISOs.

When an alpha is changed, it changes the current alpha size, plus all larger sizes where that alpha is the same as the alpha that was just modified. For example, the 4-character alpha is TEST, the 6-character alpha is TEST, and the 8-character alpha is SEAN. Changes made to the 4-character alpha are also made to the 6-character alpha, but not to the 8-character alpha.

Available options are:

*4 Character*

*6 Character*

*8 Character*

*8 Unicode* - Unicode must be enabled on the frame for it to appear in this menu. For more information, see “Unicode Alphas Check Box” on page 119.

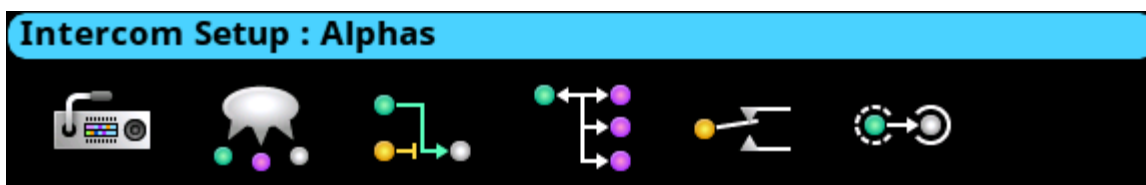

FIGURE 101. Intercom Setup | Alphas Menu Icons

## Alphas



FIGURE 102. Intercom Setup | Alphas

### Port Field

The **Port** field is used to select the port for which to configure Alpha length.

### 4 Character Field

The **4 Character** field is used to enter a four character alpha.

### 6 Character Field

The **6 Character** field is used to enter a six character alpha.

### 8 Character Field

The **8 Character** field is used to enter an eight character alpha.

### 8 Unicode Field

The **8 Unicode** field displays the eight character unicode port alpha.

This field is not editable.

To **configure the alpha size**, do the following:

1. Turning the right encoder knob, navigate to the desired **assignment type** to assign an alpha.
2. Click the **right encoder knob**.  
*The Alpha Configuration form appears.*
3. Turning the right encoder knob, navigate to the **Port field**.
4. Click the **right encoder knob**.  
*The Port field becomes active.*
5. Turning the right encoder knob, scroll to the **port** desired.
6. Click the **right encoder knob**.
7. Rotating the right encoder knob, navigate to the **4 Character, 6 Character, 8 Character, or 8 Unicode** field.
8. Click the **right encoder knob**.  
*The selected field becomes active.*
9. In the active field, enter the desired **Alpha** for the port.
10. Rotating the right encoder knob, scroll to the **first character** of the Alpha.
11. Tap the **right encoder knob** to advance to the next character.
12. Repeat **steps 9 thru 11** until the alpha is entered.  
*When finished entering the alpha, all the Alpha fields turn yellow (modification made).*
13. Click the **left encoder knob**.  
*A confirmation message appears.*

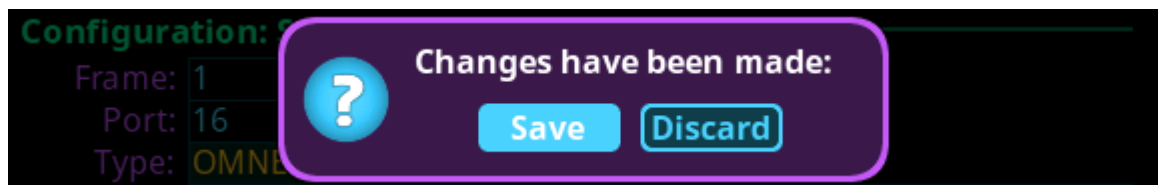

14. Verify the **Save button has the focus**.
15. Click the **right encoder knob**.  
*The modifications are saved and exits the menu.*

## Alarms Menu

The **Alarms** menu is used to access alarm notifications of events that occur in the intercom system.



FIGURE 103. Alarms Menu Icons

When an alarm occurs, an Alarm Notification message appears on the front display, as shown in Figure 104. To clear this message, press CLR on the keypad. CLR dismisses the popup, but the alarm(s) remain unacknowledged. Pressing SHIFT, and then CLR on the popup, automatically acknowledges all of the new alarms (33 as shown below). The number of new alarms are displayed in the upper right corner of the popup window. Use the right shaft encoder or the left/right arrow buttons to scroll through the alarms.

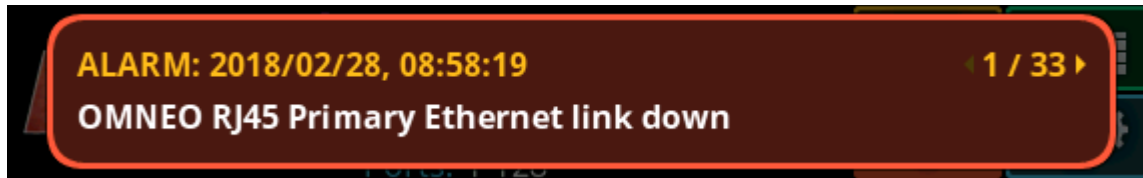

FIGURE 104. Alarm Popup Message

## Unacknowledged

**Unacknowledged Alarms** are alarms that have not been acknowledged. These alarms appear in the Alarms: Unacknowledged screen.



FIGURE 105. Alarms | Unacknowledged

The Unacknowledged and Active Alarms list can have up to 20 alarms displayed and scrollable. More than 20 alarms are pushed to a new page, as shown in Figure 106.

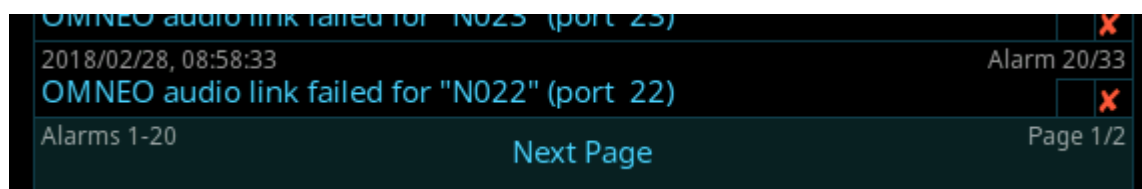
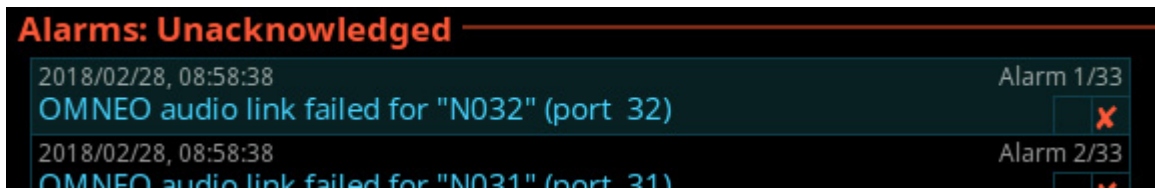

FIGURE 106. Alarms Next Page Button

To **acknowledge an alarm**, do the following:

1. Click the **Unacknowledged Alarms icon**.  
*The Unacknowledged Alarms list appears.*



2. Navigate to the desired **alarm to acknowledge**.
3. Click the **right encoder knob**.  
*A popup message appears confirming the acknowledgement.*

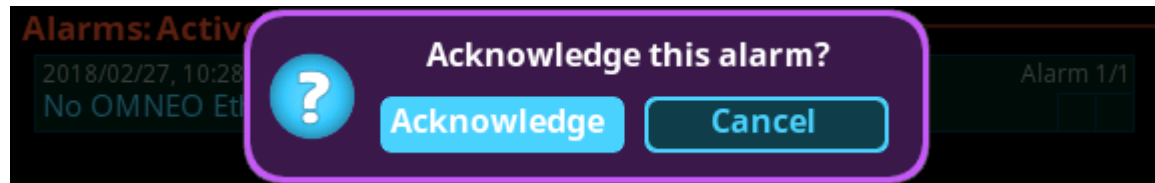

4. Navigate to the **Acknowledge button**.
5. Click the **right encoder knob**.  
*The alarm is acknowledged and cleared from the unacknowledged alarm list. A green check mark can be seen in the Active Alarm list indicating it is acknowledged. ✓ (See Figure 107).*

**NOTE:** Pressing SHIFT+SEL prompts acknowledging ALL alarms at once.

## Active

**Active Alarms** are alarm notifications that are currently active. There are two types of alarms seen on this screen; Clearable and non-clearable alarms.

*Clearable Alarms* Non-serious issues that are more notification than alarm. Clearable alarms display a red X icon **X** at the right edge. These alarms can be removed from the alarm list.

*Non-Clearable Alarms* More serious issues that should be resolved and are not removed from the alarm list until the problem is fixed.

**NOTE:** The first check box indicates if the alarm has been acknowledged.

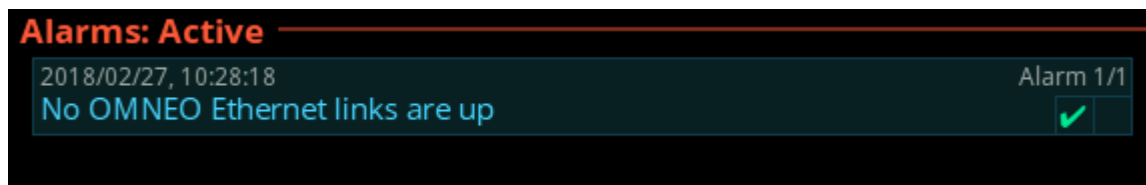
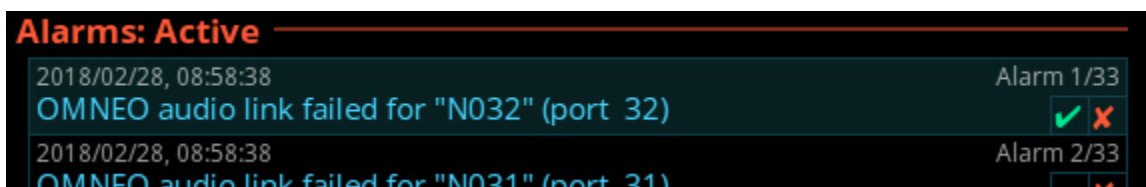

**FIGURE 107.** Alarms | Active with Clearable and Non-Clearable Alarms

To clear alarms from the Active alarm list, do the following:

1. Navigate to the **Active icon**.
2. Click the **right encoder knob**.  
*The Active list appears.*

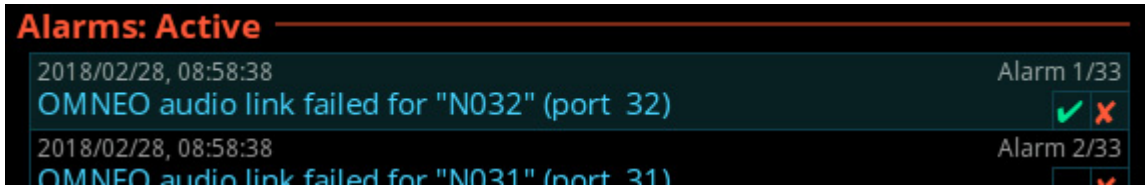

3. Navigate to the desired **alarm to clear**.
4. Click the **right encoder knob**.  
*A popup message appears confirming the Clear.*

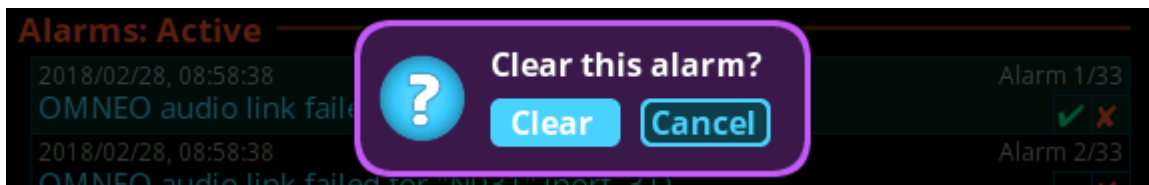

5. Click the **Clear button**.  
*The alarm is cleared and removed from the Active List.*

**NOTE:** When viewing all alarms, and an alarm is not acknowledged and not cleared, and then when SEL is pressed a prompt to Acknowledge or Clear is displayed.

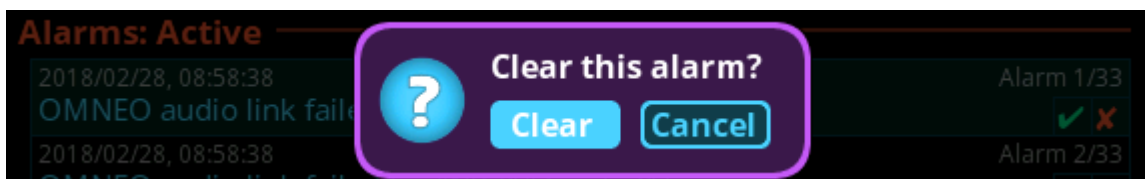
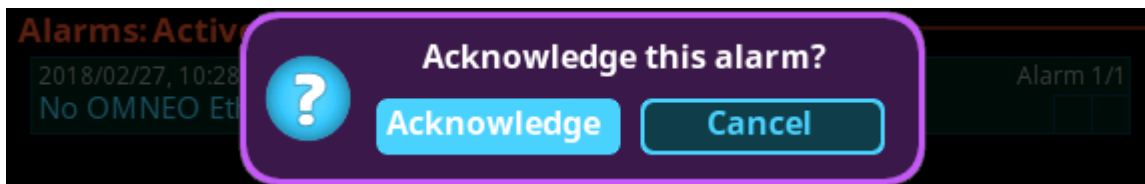

When viewing all alarms and pressing SHIFT+SEL (or SHIFT + Right Click) prompts to Acknowledge All or Clear All (clearable) alarms at once.

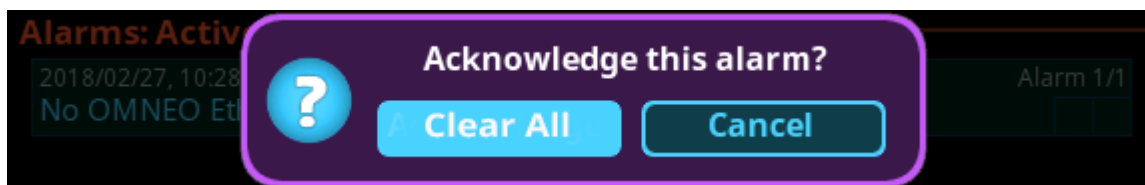
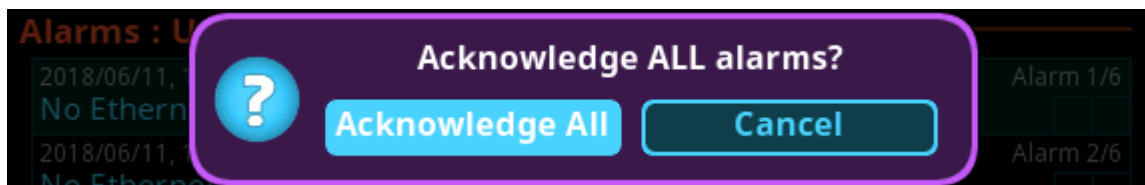



---

*Notes*

---

**Bosch Security Systems, Inc.**

12000 Portland Avenue South

Burnsville, MN 55337 U.S.A.

[www.boschsecurity.com](http://www.boschsecurity.com)