

Panasonic®

Operating Instructions <Operations and Settings>

Live Switcher

Model No. **AV-HS410N**

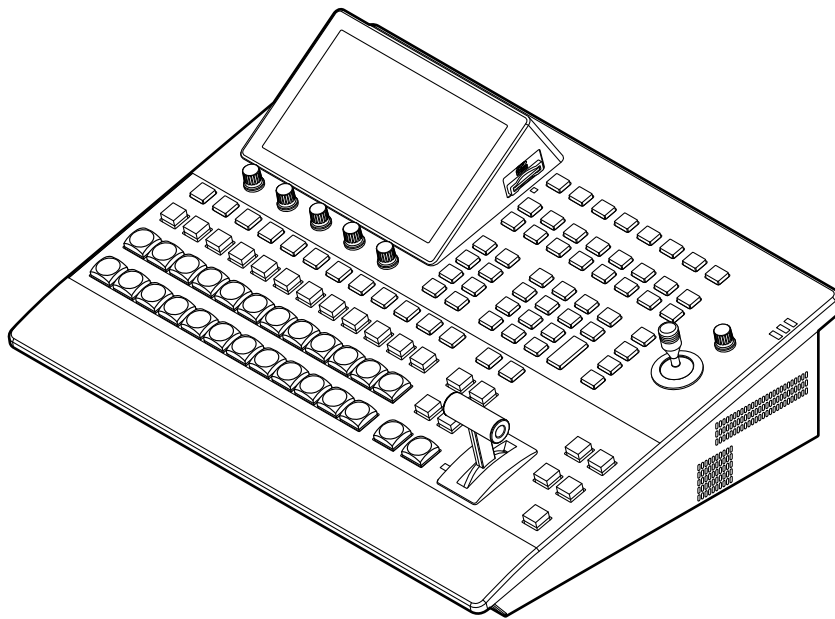

- **How the Operating Instructions are configured**

- **<Basics>:**

- The <Basics> describes the procedure for connection with the required equipment and for installation. Before installing this unit, be sure to take the time to read through <Basics> to ensure that the unit will be installed correctly.

- **<Operations and Settings> (this manual):**

- This <Operations and Settings> describes how to operate the unit and how to establish its settings.

- **For details on how to perform the basic menu operations, refer to “2-2. Basic menu operations” in the <Basics>.**

ENGLISH

VQT3U71A(E)

● **Information on software for this product**

1. Included with this product is software licensed under the GNU General Public License (GPL) and GNU Lesser General Public License (LGPL), and users are hereby informed that they have the right to obtain, change and redistribute the source codes of this software.

To obtain the source codes, go to the following home page:

<http://pro-av.panasonic.net/>

The manufacturer asks users to refrain from directing inquiries concerning the source codes they have obtained and other details to its representatives.

2. Included with this product is software which is licensed under MIT-License.

Details on the above software can be found on the CD provided with the unit. Refer to the folder called "LDOC". (Details are given in the original (English language) text.)

Trademarks and registered trademarks

- Microsoft®, Windows® XP, Windows Vista®, Windows® 7 and Internet Explorer® are either registered trademarks or trademarks of Microsoft Corporation in the United States and other countries.
- Intel® and Intel® Core™ are trademarks or registered trademarks of Intel Corporation in the United States and other countries.
- Adobe® and Reader® are either registered trademarks or trademarks of Adobe Systems Incorporated in the United States and/or other countries.
- SDHC Logo is a trademark of SD-3C, LLC.
- Primatte® is a registered trademark of IMAGICA DIGIX Inc.
- The copyrights of Primatte® belong to IMAGICA DIGIX Inc.
- The patents for Primatte® belong to IMAGICA DIGIX Inc.
- Other names of companies and products contained in these Operating Instructions may be trademarks or registered trademarks of their respective owners.

About copyright and licence

Distributing, copying, disassembling, reverse compiling, reverse engineering, and also exporting in violation of export laws of the software provided with this unit are expressly prohibited.

Abbreviations

The following abbreviations are used in this manual.

- Microsoft® Windows® 7 Professional SP1 32/64-bit is abbreviated to "Windows 7".
- Microsoft® Windows Vista® Business SP2 32-bit is abbreviated to "Windows Vista".
- Microsoft® Windows® XP Professional SP3 and Microsoft® Windows® XP Home Edition SP3 are abbreviated to "Windows XP".
- Windows® Internet Explorer® 8.0 is abbreviated to "Internet Explorer".
- In this manual, model AV-HS410N is given as "AV-HS410".
- Both SD memory cards and SDHC memory cards are described as "memory cards" in this manual. When individual descriptions are provided, they are featured individually.
- Personal computers are referred to as "computers".

Illustrations and screen displays featured in the manual

- What is shown in the manual's illustrations and screen displays may differ from how it is actually appears.

Contents

Before use	5	1-5. DSK (downstream key)	35
Overview	5	1-5-1. Selecting the DSK type	35
Concerning the ratings display	5	1-5-2. Selecting the DSK material	36
Disclaimer of warranty	5	1-5-3. DSK transitions	36
Network security	5	1-5-4. DSK preview.....	37
Concerning differences in the system versions	6	1-5-5. DSK adjustments	37
1. Basic operations	7	1-5-6. DSK decorations	38
1-1. Background transition.....	7	1-5-7. Masking the DSK signals	39
1-1-1. Selecting the bus.....	7	1-6. Key Link	40
1-1-2. Selecting the bus using the SHIFT function	7	1-7. FTB (Fade to Black)	41
1-1-3. Selecting the bus mode.....	8	1-8. Internal color signals.....	42
1-1-4. Selecting the transition mode.....	8	1-8-1. Setting the color background	42
1-1-5. Manual transition	9	1-8-2. Setting the Wash effect	42
1-1-6. Auto transition	9	1-9. Switching the AUX output	44
1-1-7. Cut transition	9	1-9-1. Selecting the AUX output materials	44
1-2. Wipe	10	1-9-2. AUX1 transitions.....	44
1-2-1. Selecting the wipe pattern.....	10	1-9-3. Setting enable/disable for the AUX1	
1-2-2. Selecting the wipe direction	11	transition.....	45
1-2-3. Wipe decorations (border, soft effect)	11	1-10. Memory	46
1-2-4. Setting the wipe start position	12	1-10-1. Memory registration and recall items	47
1-2-5. Modifying wipe	12	1-10-2. Storing the settings in the memory (Store)	47
1-2-6. Setting the latency.....	14	1-10-3. Recalling the operations stored in the memory	
1-3. Key.....	15	(Recall).....	48
1-3-1. Selecting the key type	15	1-10-4. Memory preview	49
1-3-2. Selecting the key material	16	1-10-5. Deleting the operations stored in the memory	
1-3-3. Key transitions.....	17	(Delete)	50
1-3-4. Key preview	19	1-10-6. Selecting the buses whose settings are to be	
1-3-5. Adjusting the luminance key and linear key	19	registered and or played back	51
1-3-6. Adjusting the chroma key	20	1-10-7. Registering the material selection items	52
1-3-7. Key decorations.....	26	1-10-8. Setting effect dissolve	
1-3-8. Masking the key signals	27	(shot memory).....	52
1-3-9. Flying key	28	1-10-9. Editing event memory timelines	53
1-3-10. Setting the priority	28	1-10-10. Registering memories (Register)	59
1-4. PinP (picture in picture).....	29	1-11. Video memories	60
1-4-1. Selecting the PinP channel and material	29	1-11-1. Recording still images (Still).....	61
1-4-2. Transition between PinP materials	29	1-11-2. Recording moving images (Clip)	62
1-4-3. Selecting Shape	30	1-11-3. Saving Images in Flash Memory.....	63
1-4-4. PinP preview	30	1-11-4. Playing back moving images (Clip)	64
1-4-5. PinP transitions	30	1-12. Memory card.....	67
1-4-6. PinP adjustments	31	1-12-1. Initializing the memory cards	69
1-4-7. Linking PinP1 and PinP2.....	32	1-12-2. Saving data on memory cards	69
1-4-8. PinP decorations	33	1-12-3. Loading data from memory cards	70
1-4-9. Trimming settings	34	1-12-4. Deleting files on memory cards.....	71
		1-12-5. Displaying the memory card information.....	71
		1-13. Waveform monitor settings.....	72
		1-14. Setting the status display.....	73

Contents

2. Input/output signal settings	74	3. System settings.....	102
2-1. Input signal settings	74	3-1. Setting the system format	102
2-1-1. Setting the frame synchronizer	76	3-2. Setting the crosspoints	103
2-1-2. Setting the input mode	77	3-2-1. Assigning signals to the crosspoints	103
2-1-3. Setting the delay amount	78	3-2-2. Setting the crosspoint switching.....	104
2-1-4. Freezing the input signals	78	3-3. Button assignments.....	105
2-1-5. Setting the material names	78	3-3-1. Setting the user buttons	105
2-1-6. Setting the up-converter.....	79	3-4. Setting the date and time	106
2-1-7. Setting the video process function	80	3-5. Network settings	106
2-1-8. Setting the analog input gain (option)	80	3-6. Setting the built-in display backlight and	
2-1-9. Setting the analog composite input signals		button illumination.....	107
(option).....	81	3-7. Status displays.....	108
2-1-10. Setting the DVI input signals	82	3-7-1. Alarm status displays	108
2-1-11. Displaying the DVI input signal information.....	86	3-7-2. Alarm message	108
2-1-12. Adjusting the DVI input signals.....	87	3-7-3. Displaying the version information and	
2-1-13. Automatic adjustment of the black level and		option information.....	109
white level (analog input signals)	87	3-8. Initialization	110
2-2. Output signal settings	88	3-8-1. Initializing setting data.....	110
2-2-1. Assigning the output signals	89	3-8-2. Initializing fader	110
2-2-2. Setting the SDI output color range.....	89	4. External interfaces	111
2-2-3. Setting the DVI output signals	90	4-1. Setting the GPI I/O	111
2-2-4. Setting the down-converter (option)	92	4-2. LAN.....	115
2-3. Setting the sync signals.....	93	4-3. EDITOR.....	115
2-4. Adjusting the output signal phase	93	4-4. COM.....	115
2-5. Setting the multi view display.....	97	4-5. Plug-in software	116
2-5-1. Setting the screen layout.....	97	5. Setting menu table	117
2-5-2. Setting the split frame and characters.....	98	Appendix (glossary).....	139
2-5-3. Setting the tally displays.....	98	Index	142
2-5-4. Changing the material names	99		
2-5-5. Setting the level meters.....	100		
2-5-6. Setting the input signal marks.....	100		
2-5-7. Setting the markers	100		
2-5-8. High-resolution multi view mode	100		
2-6. Setting the ancillary data and embedded			
audio data	101		

Before use

■ Overview

This unit is a 1 ME digital video switcher which supports a multiple number of HD and SD formats.

Despite its compact size, it comes with eight SDI inputs, one DVI-D input, five SDI outputs and one DVI-D output.

The unit comes with a luminance key and chroma keys provided as keyers in addition to the background transitions based on the cut, mix and wipe functions.

It also has one DSK line and two PinP lines for enabling video recording, playback and a host of other video production functions.

Furthermore, using the multi view display settings, the screen of a monitor can be split into a number of sections to accommodate up to sixteen images, enabling the number of monitors to be reduced and a space-saving system to be configured at low cost.

■ Concerning the ratings display

The unit's name, model number and electrical ratings are indicated on its side panel.

■ Disclaimer of warranty

IN NO EVENT SHALL Panasonic Corporation BE LIABLE TO ANY PARTY OR ANY PERSON, EXCEPT FOR REPLACEMENT OR REASONABLE MAINTENANCE OF THE PRODUCT, FOR THE CASES, INCLUDING BUT NOT LIMITED TO BELOW:

- ① ANY DAMAGE AND LOSS, INCLUDING WITHOUT LIMITATION, DIRECT OR INDIRECT, SPECIAL, CONSEQUENTIAL OR EXEMPLARY, ARISING OUT OF OR RELATING TO THE PRODUCT;
- ② PERSONAL INJURY OR ANY DAMAGE CAUSED BY INAPPROPRIATE USE OR NEGLIGENT OPERATION OF THE USER;
- ③ UNAUTHORIZED DISASSEMBLE, REPAIR OR MODIFICATION OF THE PRODUCT BY THE USER;
- ④ INCONVENIENCE OR ANY LOSS ARISING WHEN IMAGES ARE NOT DISPLAYED, DUE TO ANY REASON OR CAUSE INCLUDING ANY FAILURE OR PROBLEM OF THE PRODUCT;
- ⑤ ANY PROBLEM, CONSEQUENTIAL INCONVENIENCE, OR LOSS OR DAMAGE, ARISING OUT OF THE SYSTEM COMBINED BY THE DEVICES OF THIRD PARTY;
- ⑥ ANY INCONVENIENCE, DAMAGES OR LOSSES RESULTING FROM ACCIDENTS CAUSED BY AN INADEQUATE INSTALLATION METHOD OR ANY FACTORS OTHER THAN A DEFECT IN THE PRODUCT ITSELF;
- ⑦ LOSS OF REGISTERED DATA CAUSED BY ANY FAILURE;
- ⑧ ANY DAMAGE OR CLAIMS DUE TO LOSS OR LEAKAGE OF IMAGE DATA OR SETTING DATA SAVED ON THIS UNIT OR ON A MEMORY CARD OR COMPUTER.

■ Network security

The unit also has functions which are used when it is connected to a network. Using the unit when it has been connected to a network may possibly give rise to the following issues.

- ① Leakage or theft of information through this unit
- ② Use of this unit for illegal operations by persons with malicious intent
- ③ Interference with or stoppage of this unit by persons with malicious intent

It is your responsibility to take precautions such as those described below to protect yourself against the above network security risks.

- Use this unit in a network secured by a firewall, etc.
- If this unit is connected to a network that includes computers, make sure that the system is not infected by computer viruses or other malicious entities (using a regularly updated antivirus program, anti-spyware program, etc.).

The following points should be borne in mind as well.

- Use with the same segment is recommended for the equipment which is connected to the unit.
If the unit is connected to equipment whose segments are different, events dependent upon the settings inherent to the network equipment, for instance, may occur so thoroughly check the connections with the equipment to which the unit will be connected prior to the start of operation.
- Do not choose an installation location where the unit, cables and other parts will be easily damaged.

Before use

■ Concerning differences in the system versions

This manual describes the functions which can be actuated in any model whose system version is V2.00.00 and up. The applicable functions are referred to as “**This function can be actuated in any model whose system version is V2.00.00 and up**”.

If the model has a system version below V2.00.00, the functions concerned cannot be used. Neither will the menus and menu items concerned be displayed.

● How to check the system version

To check the system version of this unit, select System menu → Main Version sub menu → System Version item, and check the display for this item.

☞ Refer to “3-7-3. Displaying the version information and option information”.

● Restrictions on menus and functions

[Restrictions on menus]

Menu	Sub menu	Item	Model with system version V2.00.00 and up	Model with system version below V2.00.00
Video Memory	Clip1 Play Mode	Reverse	✓	—
		Variable	✓	—
	Clip2 Play Mode	Reverse	✓	—
		Variable	✓	—
	Trans Sync	All items	✓	—
	Memory	All items	✓	—

✓: Valid
—: Invalid

[Restrictions on functions]

Function		Model with system version V2.00.00 and up	Model with system version below V2.00.00	
Status display	Still image (Still)	✓	—	Only a list of the names is displayed.
	Moving image (Clip)			
	Memory card			
Video memory saving	The images in the video memory are saved in the flash memory area.	✓	—	The images in the video memory cannot be saved automatically. Save the images manually on the memory card.
Moving image (Clip) playback	Moving image (Clip) operations are performed using the number keys.	✓	—	Moving image (Clip) cannot be operated using the number keys. Operate them using the menu.

✓: Valid
—: Invalid

1. Basic operations

1-1. Background transition

1-1-1. Selecting the bus

Press one of the crosspoint buttons to select the material to be used for the background transition.

Depending on the operating status, the button pressed will light in one of two colors.

Lighting in red	When the selected input signals are output to PGM. (However, the indicator lights in amber during FTB operations.)
Lighting in green	When the selected input signals are not output to PGM.

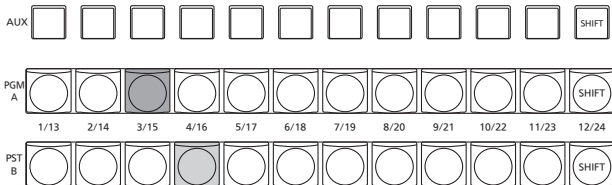

■ Lighting in red
■ Lighting in green

- When the crosspoint buttons are held down, the button numbers and the names of the input materials assigned to the buttons are displayed on the built-in display in the form of a list for as long as the crosspoint buttons remain held down.

CROSS POINT ASSIGN												
XPT:	1	2	3	4	5	6	7	8	9	10	11	12
SKG:	BLK	IN1	IN2	IN3	IN4	IN5	IN6	IN7	IN8	DVI	A1	SHIFT
XPT:	13	14	15	16	17	18	19	20	21	22	23	24
SKG:	A2	B1	B2	CBAR	CBD1	ST1V	ST2V	None	KOUT	CLN	None	SHIFT

1-1-2. Selecting the bus using the SHIFT function

The SHIFT function enables two materials to be allocated — the front material and the rear material — to one button, and the materials to be selected using the [SHIFT] button. A total of 24 materials — front materials (1 to 12) and rear materials (13 to 24) — can be allocated to the three groups of 12 crosspoint buttons whether these buttons are the PGM/A bus crosspoint buttons, PST/B bus crosspoint buttons or AUX bus crosspoint buttons.

There are actually two SHIFT functions: “All SHIFT” for switching all the front materials to the rear materials or vice versa, and “Single SHIFT” for switching the front material of one crosspoint button with its rear material or vice versa. “All SHIFT” works once the SHIFT function has been allocated to one of the user buttons.

“Single SHIFT” works once the SHIFT function has been allocated to the No.12 or No.1 crosspoint button of the crosspoint button group concerned by a menu operation.

All SHIFT

All SHIFT is used to switch all the materials of the PGM/A bus crosspoint buttons, PST/B bus crosspoint buttons or AUX bus crosspoint buttons from front materials to rear materials or vice versa.

The user button to which the SHIFT function has been allocated is used to switch between the front materials and rear materials.

- Allocate the SHIFT function to one of the user buttons. (For the method used to allocate this function to the user button, refer to “3-3-1. Setting the user buttons”.)
- Each time the [SHIFT] button (user button) is pressed, the front materials are switched to the rear materials or vice versa.

- When the rear materials (13 to 24) have been selected, the [SHIFT] button (user button) lights in amber.
- When the button is pressed again, it goes off, and the front materials (1 to 12) are now selected.

1. Basic operations

Single SHIFT

Single SHIFT is used to switch the individual material of a PGM/A bus crosspoint button, PST/B bus crosspoint button or AUX bus crosspoint button from a front material to a rear material or vice versa.

Switching between the front material and rear material is done using the crosspoint button in which the SHIFT function is allocated.

The SHIFT function can be allocated to button No.1 or No.12.

■ Allocating the SHIFT function

- Press the  button to light its indicator, and display the XPT menu.
- Use [F1] to display the XPT Setting sub menu.

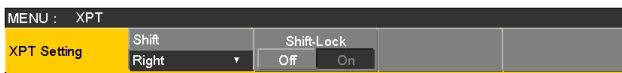

- Use [F2] to select the button to which the SHIFT function is to be allocated using the Shift item.

Right	Button No.12
Left	Button No.1
Off	Function is not allocated.

- Use [F3] to select the operation to be performed when the [SHIFT] button is pressed using the Shift-Lock item.

Off	The rear material is selected only while the [SHIFT] button is pressed.
On	The front material and rear material are switched each time the [SHIFT] button is pressed.

- To use the materials that have been set in the button to which the SHIFT function is allocated, either set the SHIFT function off or allocate the SHIFT function to another button.
- If the [SHIFT] button for "Single SHIFT" is pressed when the rear materials (13 to 24) have been selected using "All SHIFT", the bus crosspoint buttons concerned will be switched to the front materials.
- When the crosspoint buttons are held down, the button numbers and the names of the input materials assigned to the buttons are displayed on the built-in display in the form of a list for as long as the crosspoint buttons remain held down.

1-1-3. Selecting the bus mode

Select the A/B bus system or flip-flop system (PGM/PST system) from the setting menu.

- Press the  button to light its indicator, and display the Config menu.
- Use [F1] to display the Operate sub menu.



- Use [F2], and select the A/B or PGM/PST (flip-flop system) using the Bus Mode item.

A/B	When the fader lever is at side A, the signals selected by the A bus are replaced PGM materials. When the fader lever is at side B, the signals selected by the B bus are replaced PGM materials.
PGM-A/ PST-B	Using a flip-flop system, the signals selected by the A bus are always replaced PGM materials, and the signals selected by the B bus are always replaced PST materials.
PGM-B/ PST-A	Using a flip-flop system, the signals selected by the B bus are always replaced PGM materials, and the signals selected by the A bus are always replaced PST materials.

1-1-4. Selecting the transition mode

Select the transition mode using the MIX and WIPE buttons.

- Press the [BKGD] button in the transition area so that its indicator lights in amber.
When the [BKGD] button and [KEY] button are pressed at the same time, both buttons are selected.
- Use the [MIX] and [WIPE] buttons in the transition area to select the background transition mode.
The indicator of the selected button lights in amber.

1. Basic operations

1-1-5. Manual transition

Operate the fader lever to execute transitions manually. If the fader lever has been operated during auto transition, auto transition will be switched to manual operation as soon as the fader position overtakes the amount of the transition being executed.

The bus tally LEDs on the left of the fader lever indicate the program bus output status.

Top LED only lights	PGM/A bus output
Top and bottom LEDs light	During the transition
Bottom LED only lights	PST/B bus output

1-1-6. Auto transition

- When the [AUTO] button is pressed, the transition is executed automatically using the transition time which has been set.
- The transition is executed in the remaining time when the [AUTO] button is pressed while the fader lever is being operated.
- The auto transition time is set using the Time menu.

① Press the **TIME** button to light its indicator, and display the Time menu.

② Use [F1] to display the BKGD sub menu.

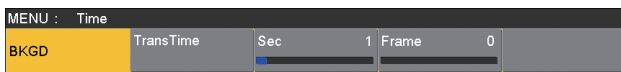

③ Set the transition time.

When setting the transition time in frame units

Use [F4] to set the transition time in frames.

When setting the transition time in second units

Use [F3] to set the time in seconds and [F4] to set it in frames.

The display unit is set by selecting Config menu → Operate sub menu → Time Unit item.

Sec	The time is displayed as a number of seconds.
Frame	The time is displayed as a number of frames.

Any time from 0 to 999f can be set. The time which can be set when seconds are used as the display unit differs depending on the system format.

59.94i:	max. 33s09f	59.94p:	max. 16s39f
50i:	max. 39s24f	50p:	max. 19s49f
24PsF:	max. 41s15f	23.98PsF:	max. 41s15f

1-1-7. Cut transition

When the [CUT] button is pressed, the transition is executed instantly.

1. Basic operations

1-2. Wipe

1-2-1. Selecting the wipe pattern

The wipe patterns are selected using the number keys.

- ① Press the [BKGD PATT] button (or [KEY PATT] button).
The [BKGD PATT] button (or [KEY PATT] button) indicator lights in amber, and the pattern table screen appears on the built-in display.
- ② Use [F1] to select the page.
- ③ Use one of the number keys to select the pattern.
The corresponding button lights in amber, and the pattern is switched.
- ④ Use [F5] to close the table screen.
 - The table screen can also be closed by pressing the [BKGD PATT] button or [KEY PATT] button and turning off the button's indicator.

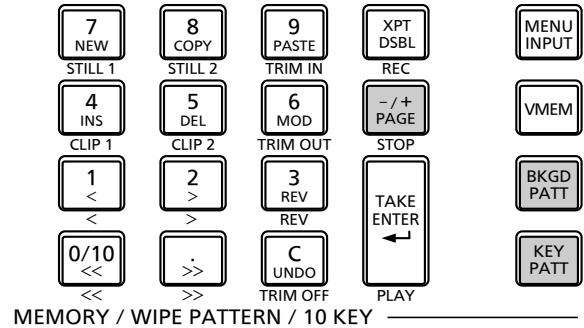

Table of wipe patterns

WIPE 1				WIPE 2			SQ 1			SQ 2		
7	8	9		7	8	9	7	8	9	7	8	9
4	5	6		4	5	6	4	5	6	4	5	6
1	2	3		1	2	3	1	2	3	1	2	3
10				10			10			10		
SL				3D 1			3D 2					
7	8	9		7	8	9	7	8	9			
4	5	6		4	5	6	4	5	6			
1	2	3		1	2	3	1	2	3			
10				10			10					

- The “SQ2: 8” pattern takes effect when the [KEY PATT] button has been pressed.

1. Basic operations

1-2-2. Selecting the wipe direction

Operate the wipe direction selector buttons to select the wipe direction for the background transition.

(The key transitions are set by the menu. The direction which is set here will not be reflected.)

☞ See “1-3-3. Key transitions”.

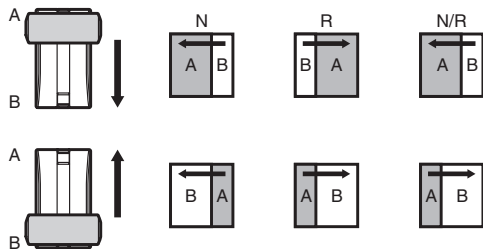

When the [R] indicator is off:

Wiping proceeds in the normal direction.

When the [R] indicator is lit:

Wiping proceeds in the reverse direction.

When the [N/R] indicator is lit:

The normal direction is replaced with the reverse direction (or vice versa) when the transition is completed.

(The lit and extinguished statuses of the [R] button are also switched in line with the direction of the wiping.)

1-2-3. Wipe decorations (border, soft effect)

A border effect or soft effect can be added to the wiping of background transitions.

Setting the border and soft effect

① Press the button to light its indicator, and display the Background menu.

② Use [F1] to display the Border sub menu.



③ Use [F2] to set On (or Off) for the border using the Border item.

④ Use [F3] to set the width of the border using the Width item.

⑤ Use [F4] to set the amount of soft effect using the Soft item.

When “On” has been selected as the Border item setting, the ratio of the soft effect to the border width is indicated as the amount of soft effect.

When only the soft effect is to be added to wipe, select “Off” as the Border item setting.

Setting the border color

① On the Background menu, use [F1] to display the Border Color sub menu.



② Use [F2], [F3] and [F4] to adjust the Hue, Sat and Lum of the border color.

■ To call the preset color

Use [F5] to select the preset color using the Load item, and press the [F5].

- When [F5] is pressed, what has been set so far is canceled and replaced with the preset color values.
- To save the values that were set before calling the preset color, refer to “1-10. Memory”.

1. Basic operations

1-2-4. Setting the wipe start position

Wipe start can be set at any desired position.

Target patterns:

WIPE1: 5
 WIPE2: 4, 5, 6, 7
 SQ1: 5
 SQ2: 4, 5, 6, 7

The WIPE pattern is set using the WIPE Position sub menu of the Background menu (or Key menu).

In the same way, the SQ pattern is set using the SQ Position sub menu of the Background menu (or Key menu).

- ① Press the button (or button) to light its indicator, and display the Background menu (or Key menu).
- ② Use [F1] to display the WIPE Position sub menu (or SQ Position sub menu).

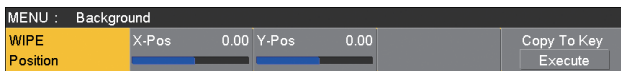

- ③ Either operate the positioners or use [F2] and [F3] to set the wipe start position using the X-Pos item and Y-Pos item.
 This setting is possible only if the target pattern has been selected for the background or key pattern.
- ④ Either operate the fader lever or press the [AUTO] button to check the wipe operation.
 (When, for instance, -50 has been set for X-Pos and -50 for Y-Pos, the following screen (or key) appears from the bottom left and wipe is performed while the screen (or key) moves to the screen center.)

<X-Pos, Y-Pos setting range>

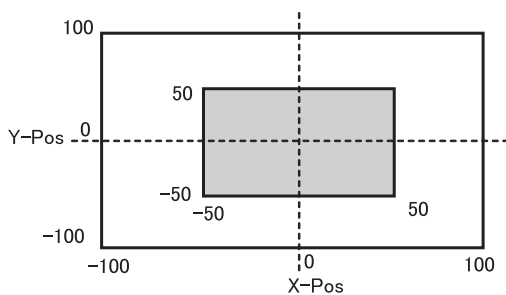

Inside screen area
 Outside screen area

- ⑤ To copy the start position setting, press [F5] (Copy to Key or Copy to BKGD).
 The background setting is copied to the key setting while the key setting is copied to the background setting.

1-2-5. Modifying wipe

Setting the 3D (page turning) effect

A lighting effect can be added to a wipe pattern. Alternatively, the page turning effect parameter can be set. These effects can be set for background transitions and key transitions.

Target patterns:

3D1: 1, 3, 7, 9

- ① Press the button (or button) to light its indicator, and display the Background menu (or Key menu).
- ② Use [F1] to display the 3D Modify sub menu.

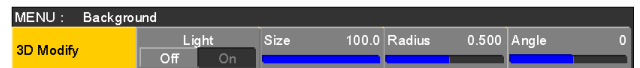

- ③ Use [F2] to select whether the lighting effect is to be added using the Light item.

On	The lighting effect is added.
Off	The lighting effect is not added.

- ④ Use [F3] to set the size when images have been reduced using the Size item.
- ⑤ Use [F4] to set the radius of the page turning effect using the Radius item.
- ⑥ Use [F5] to set the direction of the page turning effect using the Angle item.

1. Basic operations

Setting the trimming

The trimming at the time a background transition is executed can be set.

Target patterns:
SQ1, SQ2, SL, 3D1, 3D2

The “4:3” and “4:3Smth” settings for the Trim item take effect when the HD format has been selected as the system format setting.

- ① On the Background menu, use [F1] to display the Modify sub menu.



- ② Use [F2] to set the trimming operation and transition operation using the Trim item.

16:9 (On)	For trimming the edges around the material. This setting is used when a black border, for instance, can be seen around the material. When HD has been selected as the system format setting, “16:9” is displayed on the menu, but when SD has been selected as the system format setting, “On” is displayed on the menu.
4:3	For trimming using the 4:3 aspect ratio and releasing the trimming when the transition is completed.
4:3Smth	For trimming using the 4:3 aspect ratio and executing the transition to 16:9 images smoothly.
Off	No trimming

- ③ Use [F3] to select the setting for automatic trimming (4:3 or 4:3Smth) in accordance with the material using the 4:3 Auto item.

Off	All input materials are targeted for automatic trimming.
On	Using the up-converter setting, the input materials for which “Edge Crop” is selected are targeted for automatic trimming.

1. Basic operations

1-2-6. Setting the latency

A delay amount can be set for the background image or key image.

- ① Press the  button to light its indicator, and display the Config menu.
- ② Use [F1] to display the Latency sub menu.

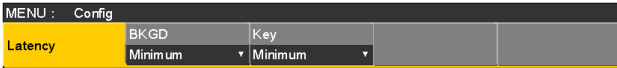

- ③ Use [F2] to set the delay amount for the background image using the BKGD item. Alternatively, use [F3] to set the delay amount for the key image using the Key item.

1F Fix	The image is delayed by one frame (1F). <ul style="list-style-type: none"> There will be no original image remaining when wipe is completed (when SQ1, SQ2, SL, 3D1 or 3D2 has been selected as the wipe pattern).
Minimum	The image is not delayed. <ul style="list-style-type: none"> However, the image will be delayed by one frame (1F) when SQ1, SQ2, SL, 3D1 or 3D2 has been selected as the wipe pattern or when the flying key has been selected.

■ BKGD items

Delay amount setting	At times other than during transitions	MIX/WIPE	SQ/SL/3D
Minimum	No delay	No delay	1F delay
1F Fix	1F delay	1F delay	1F delay

■ Key items

Delay amount setting	At times other than during transitions	MIX/WIPE	SQ/SL/3D/ Flying key
Minimum	No delay	No delay	1F delay
1F Fix	1F delay	1F delay	1F delay

1. Basic operations

1-3. Key

This operation combines the background image with another image. The key definition can be adjusted, and an edge can be added to the combined image.

Also available as materials besides KEY for combining with the background image are PinP (picture in picture) and DSK (downstream key).

The default settings for priority (image positioning) are as shown in the figure below.

<Priority default settings>

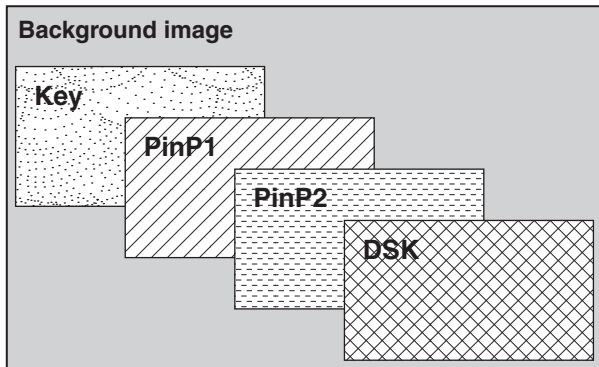

The priority for Key, PinP1 and PinP2 can be changed.
 Refer to "1-3-10. Setting the priority".

How key combinations work is shown in the figure below.

<How key composition works>

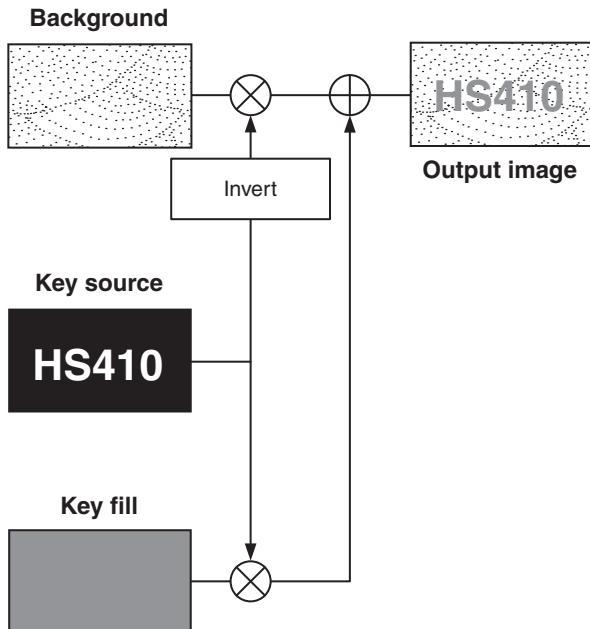

1-3-1. Selecting the key type

- ① Press the button to light its indicator, and display the Key menu.
- ② Use [F1] to display the Key sub menu.

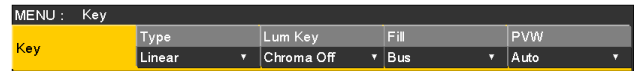

- ③ Use [F2] to select the Type item.

Lum (luminance key/ self key)	This is for creating the key signals from the luminance component or luminance and chroma component of the key fill signal.
Linear (linear key/ EXT key)	This is for creating the key signals from the luminance component of the key source signal. It is used when the key source signal and key fill signal are different.
Chroma (chroma key/ self key)	This is for creating the key signals using a specific hue of the key fill signal as the reference.
Full (full key/self key)	This is for creating the key signals using the images on the full screen as the key source signals. PinP combinations are possible in conjunction with the flying key. See "1-3-9. Flying key".

Since the luminance and chroma keys are operated as self keys, the key fill signals are used as the key source signals. For the full key, the images on the full screen are used as the key source signals.

When the luminance key, chroma key or full key has been selected as the key type, the key signals will remain unchanged even when the key source signals are switched.

When using the linear key, use material with a black background and white characters or shape to be combined by the key as the key source signal. Material which is not black and white may not be combined clearly.

Material with a white background and black characters, etc. can be reversed using the key invert function for use.

1. Basic operations

- ④ When the luminance key has been selected, the chroma component can be included in the generation of the key signals in view of the self key application. (This does not apply to the linear key.)
Use [F3], and select the setting using the Lum Key item.

Chroma On	In addition to the luminance component, the chroma component is also taken into account in the generation of the key signals. This is the setting for using a color with a low luminance component for the key signals (such as when defining blue characters).
Chroma Off	The key signals are generated from only the luminance component.

- ⑤ Use [F4] to select the fill type using the Fill item.

Bus	The bus signal is used for the key fill signal.
Matte	The internal fill matte is used for the key fill signal.

1-3-2. Selecting the key material

Selecting the key fill and key source signals

Press the [KEY] button in the AUX bus selection area, and switch the selection of the key fill signal (indicator lights in amber) and key source signal (indicator lights in green).

<Selecting the key fill signal>

With the indicator of the [KEY] button lit in amber, press one of the AUX bus crosspoint buttons 1 to 12 to select the key fill signal.

The indicator of the selected AUX bus crosspoint button lights in amber. (It will light in red if the selected signal is being output from the PGM connector.)

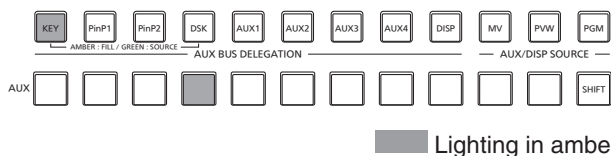

<Selecting the key source signal>

With the indicator of the [KEY] button lit in green, press one of the AUX bus crosspoint buttons 1 to 12 to select the key source signal.

The indicator of the selected AUX bus crosspoint button lights in green. (It will light in red if the selected signal is being output from the PGM connector.)

Since the luminance and chroma keys are operated as self keys, the key fill signals are used as the key source signals. When the luminance key or chroma key has been selected as the key type, the key signals will remain unchanged even when the key source signals are switched.

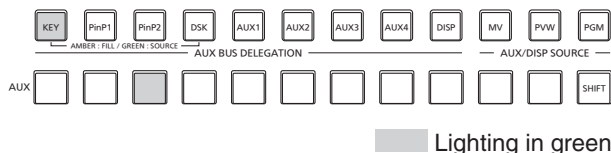

1. Basic operations

Setting the fill matte color

① Press the **[KEY CHRGY]** button to light its indicator, and display the Key menu.

② Use **[F1]** to display the Fill Matte sub menu.

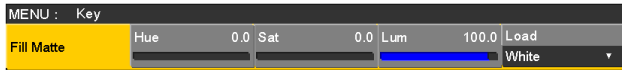

③ Use **[F2]**, **[F3]** and **[F4]** to adjust the Hue, Sat and Lum of the fill matte.

■ To call the preset color

Use **[F5]** to select the preset color using the Load item, and press the **[F5]**.

- When **[F5]** is pressed, what has been set so far is canceled and replaced with the preset color values.
- To save the values that were set before calling the preset color, refer to “1-10. Memory”.

1-3-3. Key transitions

① Select the transition mode.

Press the **[KEY]** button in the transition area to light its indicator.

To execute a background transition and key transition at the same time, press the **[BKGD]** button and **[KEY]** button together to turn on both indicators.

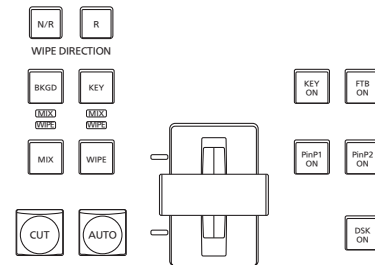

② Select the transition type.

Use the **[MIX]** button or **[WIPE]** button in the transition area to select the key transition mode.

The selected button lights in amber, and the MIX or WIPE status indicator LED depending on the selected mode lights.

If WIPE has been selected, press the **[KEY PATT]** button in the memory/wipe pattern/number key area to light its indicator, and select the wipe pattern.

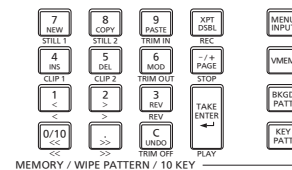

③ Set the time of the transition.

On the Time menu, use **[F1]** to display the Key sub menu.

As with a background transition, set the transition time.

1. Basic operations

④ Set the wipe direction.

On the Key menu, use [F1] to display the Transition sub menu.

Use [F1] to set “Normal” or “Reverse” using the Keyout Pattern item.

Normal	The key out pattern moves in the same direction as the key in pattern.
Reverse	The key out pattern moves in the opposite direction from the key in pattern.

<Pattern examples>

	Pattern example 1	Pattern example 2	Pattern example 3 ● WIPE1: 5 ● WIPE2: 1 to 7	Pattern example 4 ● SQ1: 5 ● SQ2: 1, 2, 4 to 7 ● 3D1: 5 ● 3D2: 1 to 3
Key in				
Key out (Normal)				
Key out (Reverse)				

: This indicates the areas where keys are combined.

- The operations for pattern example 3 are performed for the “WIPE1: 5” and “WIPE2: 1 to 7” patterns.
- The operations for pattern example 4 are performed for the “SQ1: 5”, “SQ2: 1, 2, 4 to 7”, “3D1: 5” and “3D2: 1 to 3” patterns. The same operations are performed for normal and reverse.

⑤ Execute the transition.

Press the [AUTO] button in the transition area to automatically execute the transition at the transition time that has been set.

Alternatively, execute the transition manually by operating the fader lever.

Key auto transition

When the [KEY ON] button in the transition area is pressed, the transition is automatically executed at the transition time that has been set.

During key in, the indicator of the [KEY ON] button blinks in red, and it lights in red when the transition is completed.

If the [KEY ON] button is pressed with the picture completely keyed in, the Key image transition (key out) is executed.

During key out, the indicator of the [KEY ON] button lights in red, and it goes off when the transition is completed.

If the [KEY ON] button is pressed during the transition, the transition direction is reversed.

1. Basic operations

1-3-4. Key preview

Key preview images can be output to the preview output, and the keys can be adjusted and checked.

- ① On the Key menu, use [F1] to display the Key sub menu.

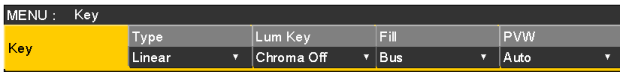

- ② Use [F5] to set the preview mode using the PVW item.

On	An image with key effects added is output to the preview output.
Off	An image with no key effects added is output to the preview output.
Auto	The preview image of the next transition is output to the preview output.

When a user button to which the On/Off settings have been allocated is pressed, the setting is switched alternately between On (button indicator lights) and Off (button indicator extinguished), and the “Auto” setting is not selected.

Menu	User button	When the user button is pressed
On	Lights	Off: Extinguished
Off	Extinguished	On: Lights
Auto	Extinguished	On: Lights

When “Auto” is selected using a menu operation, the user button indicator is turned off (extinguished).

1-3-5. Adjusting the luminance key and linear key

These steps are taken to adjust the luminance key and linear key definition.

- ① Press the button to light its indicator, and display the Key menu.

- ② Use [F1] to display the Adjust sub menu.

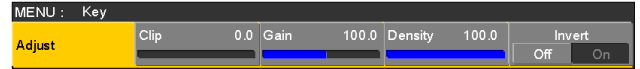

- ③ Use [F2], [F3] and [F4] to adjust the key definition.

- ④ Use [F5] to set key invert.
When “On” is selected, the key signals to be generated internally are inverted.

Operation/Parameter	Description of setting	Setting range
F2/Clip	Reference level for generating key signals	0.0 to 108.0
F3/Gain	Key amplitude	0.0 to 200.0
F4/Density	Key density	0.0 to 100.0
F5/Invert	Key signal inversion	On, Off

1. Basic operations

1-3-6. Adjusting the chroma key

Sampling is executed for the selected key materials to adjust those aspects of the key that are to be compensated.

Step 1

■ To execute the sampling automatically

- ① Press the  button to light its indicator, and display the Chroma Key menu.
- ② Use [F1] to display the Auto Compute sub menu.



- ③ Press [F2] to execute the sampling automatically. To undo what has been sampled, press [F5].

■ To execute the sampling manually

- ① Press the  button to light its indicator, and display the Chroma Key menu.
- ② Use [F1] to display the Sample sub menu.



- ③ Use [F2] to select “Composite” (composite image that combines the background image and key) using the View item.
- ④ Use [F3] to select “Select BG Color” using the Mode item.

Select BG Color	A color for the background of the foreground image is specified. Normally, either a blue or green background is specified.
------------------------	----------------------------------------------------------------------------------------------------------------------------

- ⑤ Use the positioner to move the position of the sample marker. To change the size of the sample marker, turn the rotary encoder [Z].
- ⑥ If the sample area that has been set is acceptable, press the rotary encoder [Z]. The area that has been set is now sampled.
- ⑦ To return to the pre-sampling status after sampling has been executed, press [F5]. The number of operations that can be undone is one only.

1. Basic operations

Step 2

The objective of this step is to remove the noise in the background image.
The noise is removed by carrying out this step several times.

- ① On the Chroma Key menu, use [F1] to display the Sample sub menu.



- ② Use [F2] to select "Matte" (Matte image) using the View item.
- ③ Use [F3] to select "Clean BG Noise" using the Mode item.

Clean BG Noise	The noise in the background image is removed.
-----------------------	-----------------------------------------------

- ④ Using the positioner, move the position of the sample marker to the position of the noise (white dots) in the background image.
To change the size of the sample marker, turn the rotary encoder [Z].
- ⑤ If the sample area that has been set is acceptable, press the rotary encoder [Z].
The noise in the area that has been set is now removed.
- ⑥ To return to the pre-sampling status after sampling has been executed, press [F5].
The number of operations that can be undone is one only.



Before the noise is removed



After the noise is removed

Step 3

The objective of this step is to remove the noise in the foreground image.
The noise is removed by carrying out this step several times.

- ① Use [F2] to select "Matte" (Matte image) using the View item.



- ② Use [F3] to select "Clean FG Noise" using the Mode item.

Clean FG Noise	The noise in the foreground image is removed.
-----------------------	-----------------------------------------------

- ③ Using the positioner, move the position of the sample marker to the position of the noise (black dots) in the foreground image.
To change the size of the sample marker, turn the rotary encoder [Z].
- ④ If the sample area that has been set is acceptable, press the rotary encoder [Z].
The noise in the area that has been set is now removed.
- ⑤ To return to the pre-sampling status after sampling has been executed, press [F5].
The number of operations that can be undone is one only.

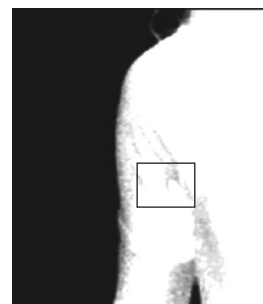

Before the noise is removed



After the noise is removed

1. Basic operations

Step 4

After steps 1 to 3 have been carried out, noise will still remain in the detail areas such as the subject's hair as shown in the image below.

Noise remaining in the detail areas is also removed in "step 4".

If there are many areas with noise, the noise is removed by carrying out this step several times.

If there are few areas with noise, adjust the noise using the Mode item ("Spill+" and "Spill-") of the Sample sub menu.



- ① Use [F2] to select "Composite" (composite image that combines the background image and key) using the View item.

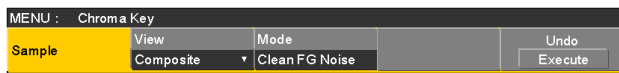

- ② Use [F3] to select "Spill Sponge" using the Mode item.

Spill Sponge	The noise remaining in the detailed areas is removed.
---------------------	-------------------------------------------------------

- ③ Using the positioner, move the position of the sample marker to the position of the remaining noise. To change the size of the sample marker, turn the rotary encoder [Z].
 - ④ If the sample area that has been set is acceptable, press the rotary encoder [Z]. The noise in the area that has been set is now removed, and the colors become more natural.
 - ⑤ To return to the pre-sampling status after sampling has been executed, press [F5]. The number of operations that can be undone is one only.
- Execute sampling in both the light and dark areas as the sample area.
 - If the noise in the foreground image is not completely removed by carrying out the steps above, proceed with the FineTuning sub menu operation.

Step 5

The objective of this step is to finely adjust the image by adjusting the noise and transparency, for example.

- ① On the Chroma Key menu, use [F1] to display the Sample sub menu.



- ② Use [F2] to select the image to be adjusted using the View item.

Composite	Composite image that combines the background image and key
Matte	Matte image
Proc.FG	Process foreground image
FG	Foreground image

- ③ Use [F3] to select the adjustment function using the Mode item. For details on the items, refer to the following pages.
- ④ Using the positioner, move the position of the sample marker to the position to be sampled. To change the size of the sample marker, turn the rotary encoder [Z].
- ⑤ If the sample area that has been set is acceptable, press the rotary encoder [Z]. The area that has been set is now sampled.
- ⑥ To return to the condition of a step earlier after an adjustment has been made, press [F5]. The number of operations that can be undone is one only.

1. Basic operations

[Spill-] [Spill+]

In these modes, the noise in the foreground image can be removed or restored step by step through repeated sampling.

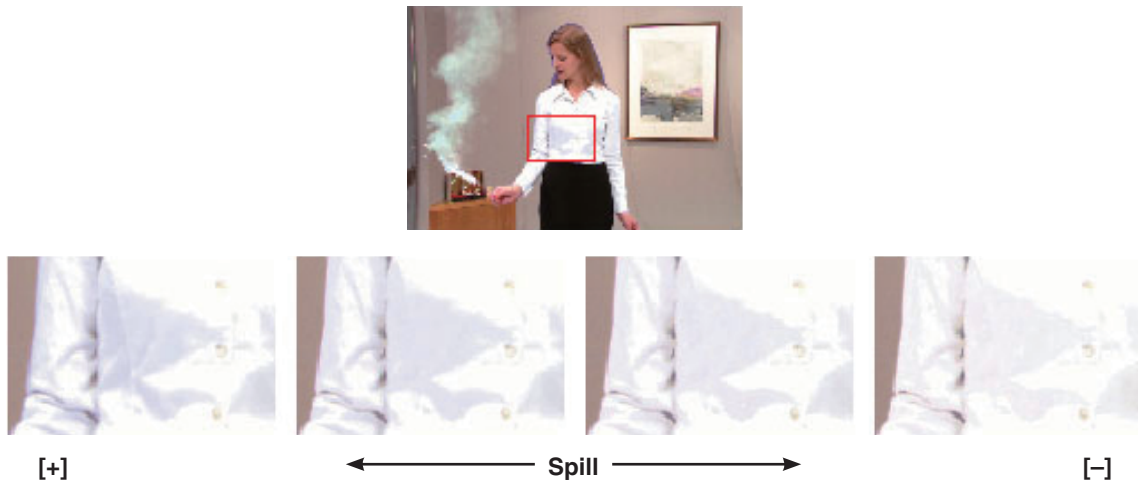

[Matte-] [Matte+]

In these modes, the matte information is adjusted.

If, for instance, the area of shadow in the foreground image is to be made lighter, use [Matte-] to adjust.

Conversely, to make it darker, use [Matte+].

Transparent images such as images of smoke or water can be made to stand out more.

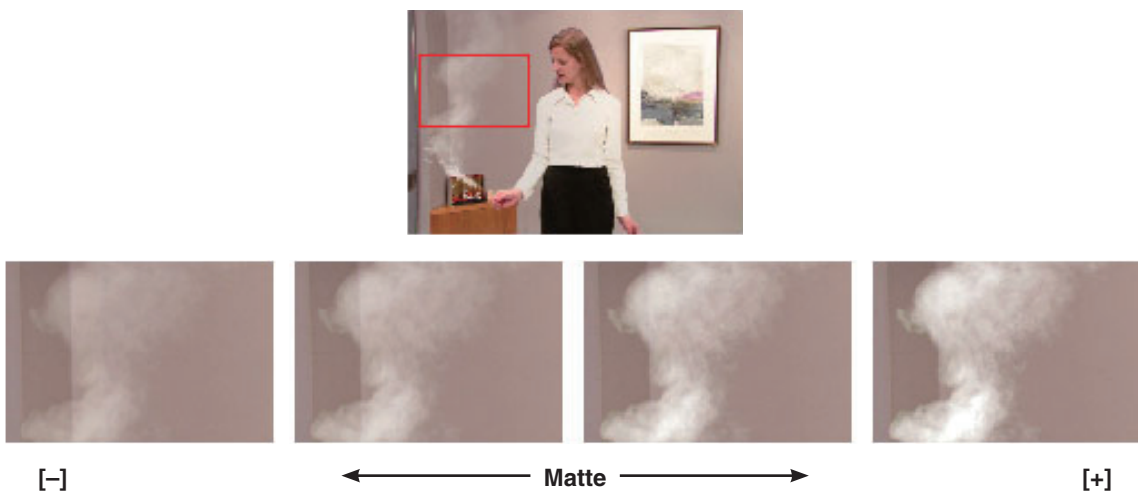

1. Basic operations

[Detail-] [Detail+]

In these modes, the noise in the background image can be removed step by step.

This is a useful way of adjusting images lost by other sampling operations to adjust the texture or transparency of images.

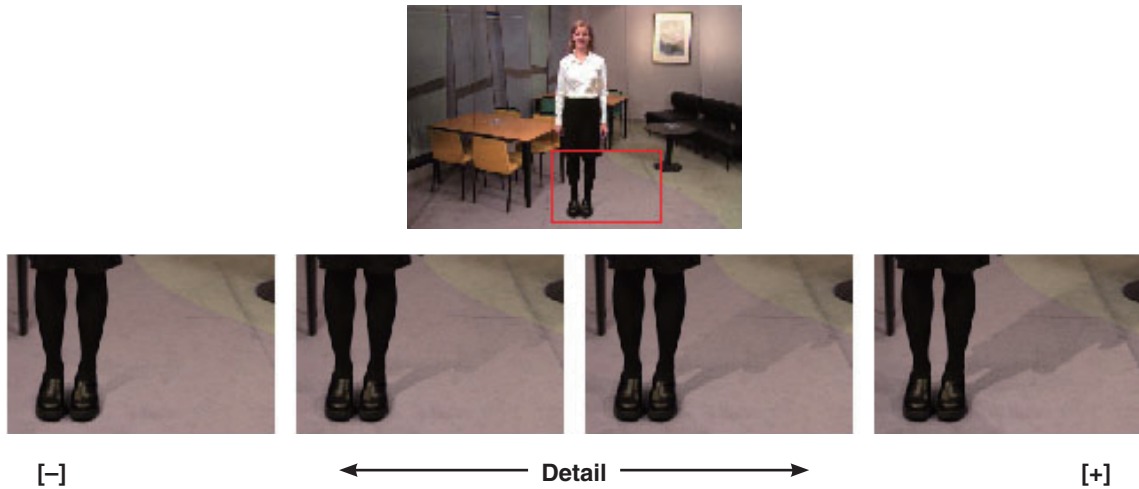

[Matte Sponge]

In this mode, the semi-transparent parts of the subject in a foreground image are selected and made matte (non-transparent). Unlike [Clean FG Noise] on the Sample sub menu, the color information is not changed in the process.

With [Clean FG Noise], the colors of the selected parts are restored to their original colors but, with [Matte Sponge], only the semi-transparent keys are made matte (non-transparent) while the colors remain unchanged and the original colors are not restored.

[Make FG Trans]

In this mode, the transparency of areas with a low transparency in the foreground image is increased.

This is useful when, for instance, areas covered with dark smoke or clouds in a foreground image are to be made semi-transparent.

[Restore Detail]

In this mode, the transparency of areas with a high transparency in the background image is reduced.

This is useful when, for instance, restoring the details of an image (such as an image with a subject who has loose hair or an image with smoke), which have been lost as a result of a [Clean BG Noise] or other such operation on the Sample sub menu, to what they were in the original image.

1. Basic operations

[FineTuning]

In this mode, detailed images can be adjusted.

- ① On the Chroma Key menu, use [F1] to display the Sample sub menu.



- ② Use [F2] to select "Composite" using the View item.
- ③ Use [F3] to select "FineTuning" using the Mode item.
- ④ Using the positioner, move the position of the sample marker to the position to be sampled.
To change the size of the sample marker, turn the rotary encoder [Z].
- ⑤ If the sample area that has been set is acceptable, press the rotary encoder [Z].
- ⑥ On the Chroma Key menu, use [F1] to display the Fine Tuning sub menu.

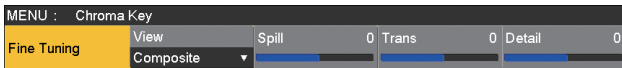

- ⑦ Use [F2] to remove or restore the noise using the Spill item.
When it is turned clockwise, a large amount of noise is removed from the foreground image, and the image colors increasingly approach the complementary color (opposite color) of the blue screen.
When it is turned counterclockwise, the image colors approach the colors of the original foreground image.
- ⑧ By turning [F3] clockwise, the matte of the colors closely resembling the colors of the foreground image can be adjusted using the Trans item.
This is useful when, for instance, areas covered with dark smoke or clouds in a foreground image are to be made semi-transparent.
- ⑨ By turning [F4] clockwise, the matte information for the colors closely resembling the colors of the background image can be adjusted using the Detail item.
This is useful when, for instance, restoring the details of an image (such as an image with a subject who has loose hair or an image with smoke), which have been lost in the foreground image as a result of sampling, to what they were in the original image.

Step 6

Finely adjust the chroma key signals which have been generated.

- ① On the Chroma Key menu, use [F1] to display the Adjust sub menu.

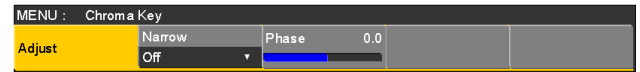

- ② Use [F2], and adjust the width of the chroma key signals using the Narrow item.
The key signal width can be adjusted horizontally in 0.5 (half-pixel) increments.
- ③ Use [F3], and adjust the horizontal phase of the chroma key signals using the Phase item.
The key signal position can be moved horizontally in 0.5 (half-pixel) increments.

1. Basic operations

1-3-7. Key decorations

A border, shadow or other edge can be added to the key.

Setting the key edge

- Press the  button to light its indicator, and display the Key menu.
- Use [F1] to display the Edge1 sub menu.

MENU : Key				
Edge1	Type	Width	Direction	Density
	Off	2	0	100%

- Use [F2] to select the edge type.

Off	An edge is not added.
Border	A border is added around the entire edge.
Drop	A diagonal border is added.
Shadow	A shadow is added.
Outline	An outline (only a border with no fill) is added.

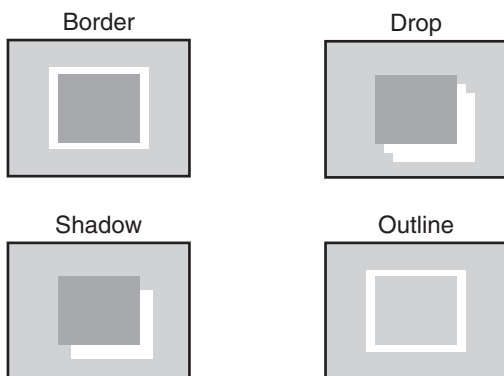

- Use [F3] to set the edge width.
- Use [F4] to set the direction (in 45-degree increments) in which "Drop" and "Shadow" will be added.

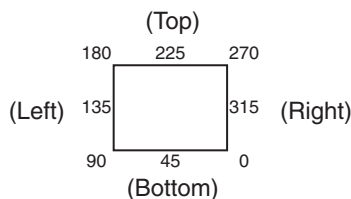

- Use [F5] to set the darkness (Density) of the edges.

Selecting the Edge Fill settings

Materials to be inserted as edges can be set.

- On the Key menu, use [F1] to display the Edge2 sub menu.

MENU : Key	
Edge2	Edge Fill
	Color

- Use [F2] to select the edge material using the Edge Fill items.

Color	The color set using Edge Color is used.
CBGD1	The color background is used.
CBGD2	
Still1	The still image video memory (Still1) is used.
Still2	The still image video memory (Still2) is used.
Clip1	The moving image video memory (Clip1) is used.
Clip2	The moving image video memory (Clip2) is used.

Setting the edge color

- On the Key menu, use [F1] to display the Edge Color sub menu.

MENU : Key							
Edge Color	Hue	0.0	Sat	0.0	Lum	100.0	Load
							Black

- Use [F2], [F3] and [F4] to adjust the Hue, Sat and Lum of the edge color.

■ To call the preset color

Use [F5] to select the preset color using the Load item, and press the [F5].

- When [F5] is pressed, what has been set so far is canceled and replaced with the preset color values.
- To save the values that were set before calling the preset color, refer to "1-10. Memory".

1. Basic operations

1-3-8. Masking the key signals

These steps are taken to mask the key signals using the mask signal of the box pattern.

- Press the  button to light its indicator, and display the Key menu.
- Use [F1] to display the Mask sub menu.



- Use [F2], and select the masking method using the Mask item.

Off	The key signals are not masked.
Manual	The area that is set using the Mask Adjust sub menu is masked.
4:3	The signals are masked to the 4:3 aspect ratio.

- Use [F3] to set whether to invert the mask signal using the Invert item.

On	The mask signal is inverted.
Off	The mask signal is not inverted.

- Use [F1] to display the Mask Adjust sub menu.

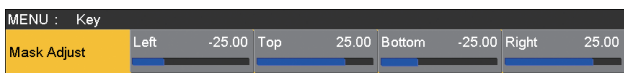

- Use [F2] to [F5] to set the area to be masked.

Operation/Parameter	Description of setting	Setting range/Initial value
F2/Left	Key left position	-50.00 to 50.00/ -25.00
F3/Top	Key top position	-50.00 to 50.00/ 25.00
F4/Bottom	Key bottom position	-50.00 to 50.00/ -25.00
F5/Right	Key right position	-50.00 to 50.00/ 25.00

The Left setting cannot exceed the Right setting (and vice versa) and, similarly, the Top setting cannot exceed the Bottom setting (and vice versa).

<Key mask setting> (figure shows the default values)

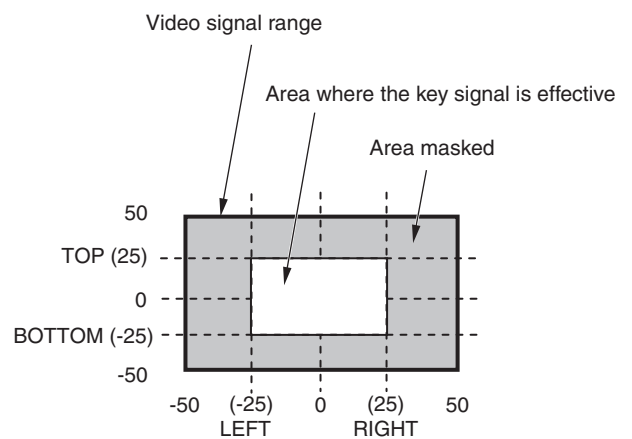

1. Basic operations

1-3-9. Flying key

Using DVE effects, this key enables the key signals that have been input to be moved, expanded or contracted. In order for the flying key to take effect, select "SQ2: 8" as the key transition.

☞ Refer to "1-2-1. Selecting the wipe pattern".

When the key transition is executed, the keys are combined by the key signals set using the flying key menu. (The transition effect is fixed at MIX.) Since the flying key uses DVE effects, the image is delayed by one frame.

- ① Press the  button to light its indicator, and display the Key menu.
- ② Use [F1] to display the Flying Key sub menu.

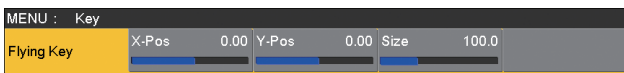

- ③ Use [F2] to set the X coordinate of the key signal using the X-Pos item.
- ④ Use [F3] to set the Y coordinate of the key signal using the Y-Pos item.
- ⑤ Use [F4] to set the key signal change size (max. 400: 400 %) using the Size item.

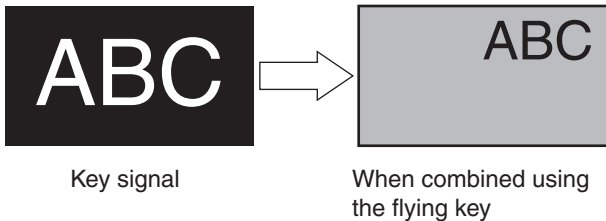

In order to add the edge of the key before the DVE effect, the thickness of the edge is also changed when the size is changed.

PinP combinations using the flying key

When "Full" is selected using the Type item in "1-3-1. Selecting the key type", PinP combinations can be performed using the flying key.

(At this point in time, the Clip item and Gain item cannot be set on the Adjust sub menu.)

With the full key, the image on the full screen serves as the key source signal so an edge will not be added unless a further step is taken.

To add an edge, mask the key signals so that the key source signals are made smaller than the entire screen.

☞ For details on masking, refer to "1-3-8. Masking the key signals".

1-3-10. Setting the priority

The relative positions of the images when key, PinP1 and PinP2 images are to be superimposed onto one another can be set.

- ① Press the  button to light its indicator, and display the Key menu.
- ② Use [F1] to display the Key Priority sub menu.

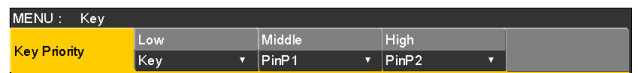

- ③ Use [F2] to [F4] to set the relative positions using the Low item, Middle item and High item.

Low	This is used to set the image to be placed at the bottom.
Middle	This is used to set the image to be placed in the middle.
High	This is used to set the image to be placed at the top.

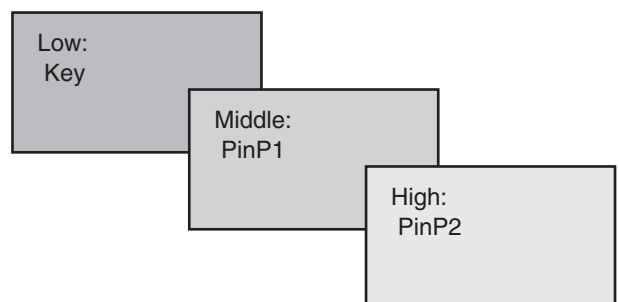

1. Basic operations

1-4. PinP (picture in picture)

Another image can be combined with the background image. This unit supports two PinP channels.

1-4-1. Selecting the PinP channel and material

Press the [PinP1] button (or [PinP2] button) among the AUX bus selector buttons.

When the [PinP1] button (or [PinP2] button) is lit, the PinP1 menu (or PinP2 menu) is displayed on the built-in display. The state in which the PinP1 materials (or PinP2 materials) are selected is now established for the AUX bus crosspoint buttons.

The selected AUX bus crosspoint button lights in amber. (It will light in red if the selected signal is a PGM output signal.)

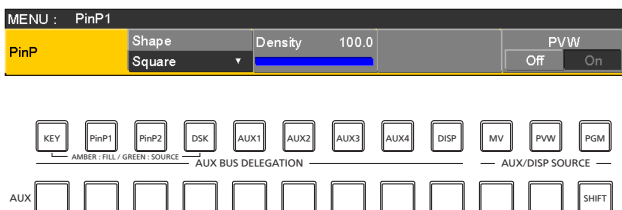

1-4-2. Transition between PinP materials

When a PinP bus material has been selected, the effect to be produced when images are switched can be executed as a MIX transition. (Bus transition function)

- When one material set to the Dot by Dot mode and another material have been switched, cut switching where the images change in an instant is performed.

- Press the **TIME** button to light its indicator, and display the Time menu.
- Use [F1] to display the PinP1 BUS Trans sub menu (or PinP2 BUS Trans sub menu).



- Use [F3] and [F4] to set the transition time.
- Use [F5] to set enable or disable for the bus transition function.

Enable	Enable
Disable	Disable

While the transition is underway, the indicator of the transition source button lights, and the indicator of the transition destination button blinks.

When the transition is completed, the indicator of the transition source button goes off, and the indicator of the transition destination button lights.

When another signal has been selected while a transition is underway, the processing for the transition will continue from the interim point.

1. Basic operations

1-4-3. Selecting Shape

Square, Circle, Heart, Star or Flower can be selected as the shape used for combining PinP images.

① Press the  button to light its indicator, and display the PinP1 menu (or PinP2 menu).

② Use [F1] to display the PinP sub menu.

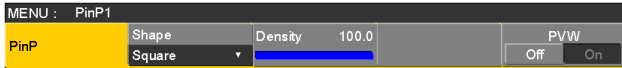

③ Use [F2] and, using the Shape item, select the shape used for combining images.

④ Use [F3] to adjust the transmissivity (darkness) applying when the images are combined using the Density item.

1-4-4. PinP preview

Select whether to output the PinP1 and PinP2 preview images to the preview output.

① On the PinP sub menu, use [F5] to set the PVW item.



On	An image with the PinP1 (or PinP2) effect added is output to the preview output.
Off	An image without the PinP1 (or PinP2) effect added is output to the preview output.

- The PVW On and Off settings can be allocated to the user buttons.
When “PinP1 PVW” (or “PinP2 PVW”) is assigned to a user button, the PinP1 image (or PinP2 image) preview output is turned on or off every time the user button is pressed.
When “PinP PVW” is assigned to a user button, the PinP1 image and PinP2 image preview outputs are simultaneously turned on or off every time the user button is pressed.
 Refer to “3-3-1. Setting the user buttons”.

1-4-5. PinP transitions

- ① Set the transition time.
On the Time menu, use [F1] to display the PinP1 sub menu (or PinP2 sub menu).
As with background transitions, set the transition time.
 Refer to “1-1-6. Auto transition”.
- ② When the [PinP1 ON] button (or [PinP2 ON] button) in the transition area is pressed, the PinP1 image (or PinP2 image) transitions (fades in) for the length of the transition time that has been set.
During fade-in, the [PinP1 ON] button (or [PinP2 ON] button) blinks in red, and when the transition is completed, it lights in red.
When the [PinP1 ON] button (or [PinP2 ON] button) is pressed after fade-in is completed, the PinP1 image (or PinP2 image) transitions (fades out).
During fade-out, the [PinP1 ON] button (or [PinP2 ON] button) lights in red, and when the transition is completed, it goes off.
If the [PinP1 ON] button (or [PinP2 ON] button) is pressed at any point during a transition, the direction of the transition is reversed.

1. Basic operations

1-4-6. PinP adjustments

Adjusting the PinP position and size

While the PinP menu is selected, adjust the X and Y coordinates using the positioner in the positioner area, and adjust the size using the rotary encoder [Z]. Alternatively, the settings can be performed on the menus.

① Press the  button to light its indicator, and display the PinP1 menu (or PinP2 menu).

② Use [F1] to display the Position sub menu.

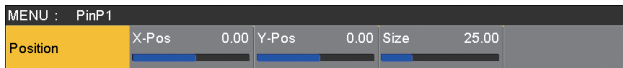

③ Either operate the positioner and the rotary encoder [Z] or use [F2], [F3] and [F4] to set the X and Y coordinates and the size using the X-Pos, Y-Pos and Size items.

Select the dot by dot mode

When the system is set to the HD mode and an SD format image is to be used for the PinP material, the images can be combined in the dot by dot mode (actual-size images). In this mode, the SD format image will not be up-converted so image deterioration can be prevented.

- When “100.00” has been selected as the Size item setting on the Position sub menu, the size used for the combination will be the same number of lines as the SD format image.

① Press the  button to light its indicator, and display the Input menu.

② Use [F2] to select the signals for inputting the PinP material using the Select item.

③ Use [F1] to display the FS sub menu.

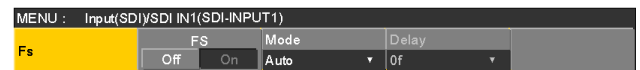

④ Use [F3] to select “Dot by Dot” using the Mode item, and press the [F3] to enter the selection.

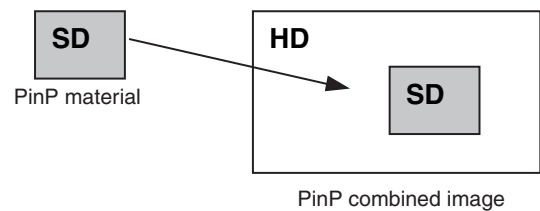

1. Basic operations

1-4-7. Linking PinP1 and PinP2

The PinP1 and PinP2 images perform a symmetrical operation for the axis whose coordinates and rotation angle have been set. The image serving as the reference is the PinP image of the menu being operated.

Setting the priority

Set the relative positions of the images when key, PinP1 and PinP2 images are to be superimposed onto one another.
 Refer to "1-3-10. Setting the priority".

Linking PinP1 and PinP2

- Press the  button to light its indicator, and display the PinP1 menu (or PinP2 menu).
- Use [F1] to display the Sync sub menu.



- Use [F2] to select the position that will serve as the reference using the Symmetry item. The image serving as the reference is the PinP image of the menu being operated.

When "X" has been selected as the Symmetry setting

The coordinates and rotation angle are made symmetrical to the X axis.

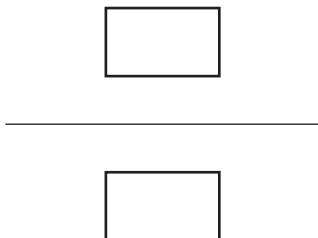

When "Y" has been selected as the Symmetry setting

The coordinates and rotation angle are made symmetrical to the Y axis.

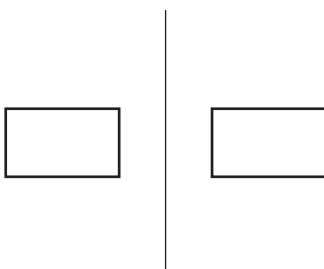

When "Center" has been selected as the Symmetry setting

The coordinates and rotation angle are made symmetrical to the center.

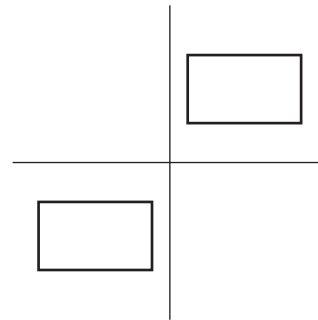

Copying the settings

The PinP1 settings can be copied to PinP2 and, similarly, the PinP2 settings can be copied to PinP1.

- On the PinP1 menu (or PinP2 menu), use [F1] to display the Sync sub menu.



- Use [F2] to select "Off" using the Symmetry item.
- When [F5] is pressed, the PinP1 (or PinP2) settings are copied and set in PinP2 (or PinP1).

Note

- The following settings are not copied.
- Trim sub menu items

1. Basic operations

1-4-8. PinP decorations

A border or soft effect can be added to PinP.

- ① Press the  button to light its indicator, and display the PinP1 menu (or PinP2 menu).
- ② Use [F1] to display the Border sub menu.



- ③ Use [F2] to set On (or Off) for the border using the Border item.
- ④ Use [F3] to set the width of the border using the Width item.
- ⑤ Use [F4] to set the amount of soft effect using the Soft item. The soft effect is OFF if 0.0 is set.
When “On” has been selected as the Border item setting, the ratio of the soft effect to the border width is indicated as the amount of soft effect.
When only the soft effect is to be added to PinP, select “Off” as the Border item setting.
- ⑥ Use [F5] to set the change in the border width using the Mode item.

Fix	The border width is kept constant.
Variable	The border width changes to suit the PinP size.

Setting the border color

- ① On the PinP1 menu (or PinP2 menu), use [F1] to display the Border Color sub menu.



- ② Use [F2], [F3] and [F4] to adjust the Hue, Sat and Lum of the border color.

■ To call the preset color

Use [F5] to select the preset color using the Load item, and press the [F5].

- When [F5] is pressed, what has been set so far is canceled and replaced with the preset color values.
- To save the values that were set before calling the preset color, refer to “1-10. Memory”.

1. Basic operations

1-4-9. Trimming settings

① Press the  button to light its indicator, and display the PinP1 menu (or PinP2 menu).

② Use [F1] to display the Trim sub menu.

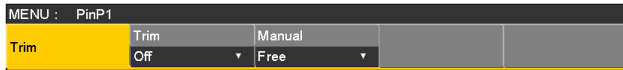

③ Use [F2] to select the trimming type using the Trim item.

Off	No trimming
4:3	Automatic trimming so that the aspect ratio is 4:3.
Manual	Trimming using the value set on the Trim Adjust sub menu.

④ Use [F3] to select the operation to be performed during the manual setting using the Manual item.

Free	The Left, Right, Top and Bottom parameters change independently. However, the Left setting cannot exceed the Right setting (and vice versa) and, similarly, the Top setting cannot exceed the Bottom setting (and vice versa).
Pair	The settings are changed in such a way that the Left and Right trimming amounts and the Top and Bottom trimming amounts are the same. (This makes for a top-bottom and left-right symmetry.)

⑤ Use [F1] to display the Trim Adjust sub menu, and use [F2], [F3], [F4] and [F5] to set the trimming values.

Operation/Parameter	Description of setting	Setting range/Initial value
F2/Left	Trimming value at left	-50.00 to 50.00/ -40.00
F3/Top	Trimming value at top	-50.00 to 50.00/ 40.00
F4/Bottom	Trimming value at bottom	-50.00 to 50.00/ -40.00
F5/Right	Trimming value at right	-50.00 to 50.00/ 40.00

<Trimming settings> (figure shows the default values)

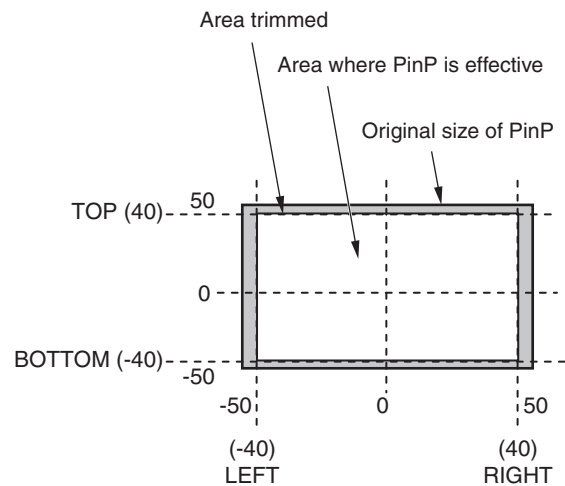

1. Basic operations

1-5. DSK (downstream key)

Characters or other images can be combined with the background image.

1-5-1. Selecting the DSK type

- ① Press the  button to light its indicator, and display the DSK menu.
- ② Use [F1] to display the DSK sub menu.

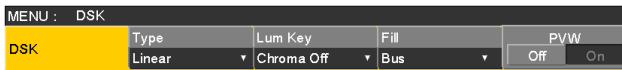

- ③ Use [F2] to select the Type item.

Lum (luminance key/self key)	This is for creating the key signals from the luminance component of the key fill signal.
Linear (linear key/EXT key)	This is for creating the key signals from the luminance component of the key source signal. It is used when the key source signal and key fill signal are different.

Since the luminance key is operated as a self key, the key fill signals are used as the key source signals. When the luminance key has been selected as the downstream key type, the key signals will remain unchanged even when the key source signals are switched.

When using the linear key, use material with a black background and white characters or shape to be combined by the key as the key source signal. Material which is not black and white may not be combined clearly. Material with a white background and black characters, etc. can be reversed using the key invert function for use.

- ④ When the luminance key has been selected, the chroma components can be contained in the key signals generated in view of the fact that it is used as a self key. (This is not applied to the linear key.)
Use [F3] to select the setting using the Lum Key item.

Chroma On	In addition to the luminance components, the chroma components are also factored in when generating the key signals. Use this setting if colors with low luminance components are used for the key signals (when, for instance, blue characters are to be removed).
Chroma Off	The key signals are generated only from the luminance components.

- ⑤ Use [F4] to select the fill type using the Fill item.

Bus	The bus signal is used for the key fill signal.
Matte	The internal fill matte is used for the key fill signal.

Setting the fill matte color

- ① On the DSK menu, use [F1] to display the Fill Matte sub menu.



- ② Use [F2], [F3] and [F4] to adjust the Hue, Sat and Lum of the fill matte.

■ To call the preset color

Use [F5] to select the preset color using the Load item, and press the [F5].

- When [F5] is pressed, what has been set so far is canceled and replaced with the preset color values.
- To save the values that were set before calling the preset color, refer to "1-10. Memory".

1. Basic operations

1-5-2. Selecting the DSK material

Selecting the DSK fill signal and DSK source signal

Press the [DSK] button in the AUX bus selection area to switch the selection of the DSK fill signal (indicator lights in amber) and DSK source signal (indicator lights in green).

<Selecting the DSK fill signal>

While the indicator of the [DSK] button is lit in amber, press one of the AUX bus crosspoint buttons 1 to 12 to select the DSK fill signal.

The indicator of the selected AUX bus crosspoint button lights in amber. (It lights in red if the selected signal is being output from the PGM connector.)

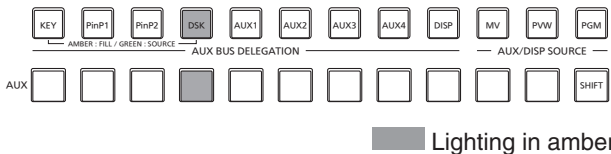

<Selecting the DSK source signal>

While the indicator of the [DSK] button is lit in green, press one of the AUX bus crosspoint buttons 1 to 12 to select the DSK source signal.

The indicator of the selected AUX bus crosspoint button lights in green. (It lights in red if the selected signal is being output from the PGM connector.)

Since the luminance key is operated as a self key, the key fill signals are used as the key source signals. When the luminance key has been selected as the downstream key type, the key signals will remain unchanged even when the key source signals are switched.

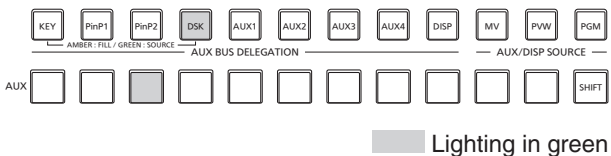

1-5-3. DSK transitions

- ① Set the transition time.
Press the **TIME** button to light its indicator, and display the Time menu.
- ② Use [F1] to display the DSK sub menu.
As with background transitions, set the transition time.
☞ Refer to “1-1-6. Auto transition”.
- ③ When the [DSK ON] button in the transition area is pressed, the DSK image is combined (fades in) for the length of the transition time that has been set.
During fade-in, the [DSK ON] button blinks in red, and when the transition is completed, it lights in red.
When the [DSK ON] button is pressed after fade-in is completed, the DSK image transitions (fades out).
During fade-out, the [DSK ON] button lights in red, and when the transition (fade-out) is completed, it goes off.
If the [DSK ON] button is pressed at any point during a transition, the direction of the transition is reversed.

1. Basic operations

1-5-4. DSK preview

Select whether to output the DSK preview image to the preview output.

- ① Press the  button to light its indicator, and display the DSK menu.
- ② Use [F1] to display the DSK sub menu.

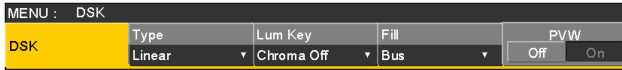

- ③ Use [F5] to set the PVW item.

On	An image with the DSK effect added is output to the preview output.
Off	An image without the DSK effect added is output to the preview output.

The PVW On and Off settings can be allocated to the user buttons.

☞ Refer to “3-3-1. Setting the user buttons”.

1-5-5. DSK adjustments

The DSK definition can be adjusted.

- ① Press the  button to light its indicator, and display the DSK menu.
- ② Use [F1] to display the Adjust sub menu.

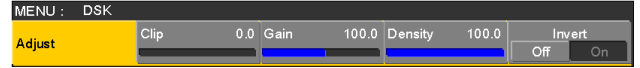

- ③ Use [F2], [F3] and [F4] to adjust the DSK (downstream key) definition.
- ④ Use [F5] to set key invert.
If “On” is set, the key signals generated internally are inverted.

Operation/Parameter	Description of setting	Setting range
F2/ Clip	Reference level for generating key signals	0.0 to 108.0
F3/ Gain	Key amplitude	0.0 to 200.0
F4/ Density	Key density	0.0 to 100.0
F5/ Invert	Key signal inversion	On, Off

1. Basic operations

1-5-6. DSK decorations

A border, shadow or other type of edge can be added to DSK.

Setting the edge

- Press the  button to light its indicator, and display the DSK menu.
- Use [F1] to display the Edge1 sub menu.

MENU : DSK				
Edge 1	Type	Width	Direction	Density
	Off	2	0	100%

- Use [F2] to select the edge type.

Off	An edge is not added.
Border	A border is added around the entire edge.
Drop	A diagonal border is added.
Shadow	A shadow is added.
Outline	An outline (only a border with no fill) is added.

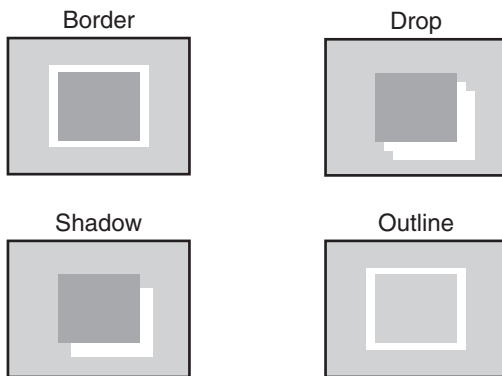

- Use [F3] to set the edge width.
- Use [F4] to set the direction (in 45-degree increments) in which "Drop" and "Shadow" will be added.

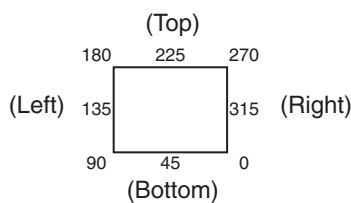

- Use [F5] to set the darkness (Density) of the edges.

Setting Edge Fill

Materials to be inserted as edges can be set.

- On the DSK menu, use [F1] to display the Edge2 sub menu.

MENU : DSK			
Edge2	Edge Fill		
	Color		

- Use [F2] to select the edge material using the Edge Fill item.

Color	The color set using Edge Color is used.
CBGD1	The color background is used.
CBGD2	
Still1	The still image video memory (Still1) is used.
Still2	The still image video memory (Still2) is used.
Clip1	The moving image video memory (Clip1) is used.
Clip2	The moving image video memory (Clip2) is used.

Setting the edge color

- On the DSK menu, use [F1] to display the Edge Color sub menu.

MENU : DSK							
Edge Color	Hue	0.0	Sat	0.0	Lum	100.0	Load
							Black

- Use [F2], [F3] and [F4] to adjust the Hue, Sat and Lum of the edge color.

■ To call the preset color

Use [F5] to select the preset color using the Load item, and press the [F5].

- When [F5] is pressed, what has been set so far is canceled and replaced with the preset color values.
- To save the values that were set before calling the preset color, refer to "1-10. Memory".

1. Basic operations

1-5-7. Masking the DSK signals

These steps are taken to mask the DSK signals using the mask signal of the box pattern.

- Press the  button to light its indicator, and display the DSK menu.

- Use [F1] to display the Mask sub menu.



- Use [F2], and select the masking method using the Mask item.

Off	The DSK signals are not masked.
Manual	The area that is set using the Mask Adjust sub menu is masked.
4:3	The signals are masked to the 4:3 aspect ratio.

- Use [F3] to set whether to invert the mask signal using the Invert item.

On	The mask signal is inverted.
Off	The mask signal is not inverted.

- Use [F1] to display the Mask Adjust sub menu.



- Use [F2] to [F5] to set the area to be masked.

Operation/Parameter	Description of setting	Setting range/Initial value
F2/Left	DSK left position	-50.00 to 50.00/ -25.00
F3/Top	DSK top position	-50.00 to 50.00/ 25.00
F4/Bottom	DSK bottom position	-50.00 to 50.00/ -25.00
F5/Right	DSK right position	-50.00 to 50.00/ 25.00

The Left setting cannot exceed the Right setting (and vice versa) and, similarly, the Top setting cannot exceed the Bottom setting (and vice versa).

<DSK mask setting> (figure shows the default values)

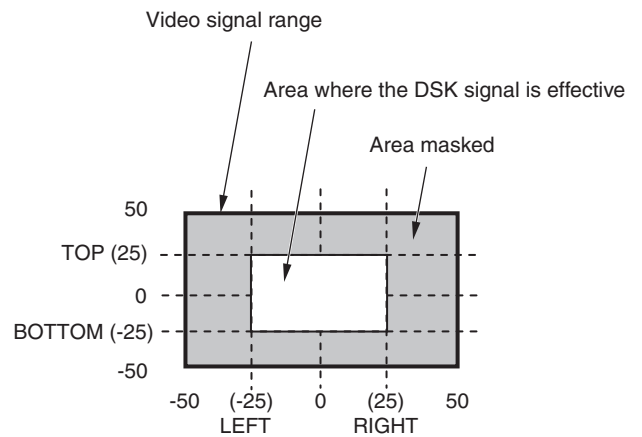

1. Basic operations

1-6. Key Link

This function makes it possible to link the “On” or “Off” setting of the [DSK ON] button and PinP buttons ([PinP1 ON] and [PinP2 ON]) with the “On” or “Off” (button indicator lights or off) of the [KEY ON] button.

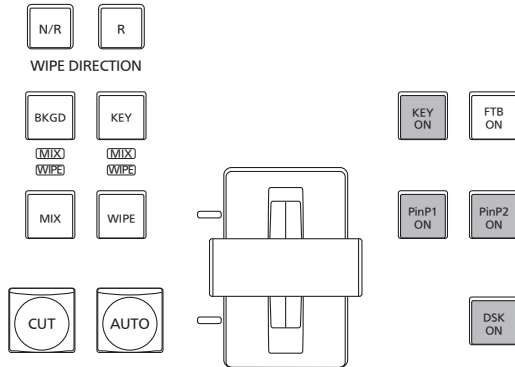

① Press the button to light its indicator, and display the Config menu.

② Use [F1] to display the Operate sub menu.



③ Use [F3] to select the link operation using the Key Link item.

Off	This releases the link with the [KEY ON] button.
DSK	<p>This links the “On” or “Off” setting of the [DSK ON] button with the “On” or “Off” setting of the [KEY ON] button.</p> <ul style="list-style-type: none"> • When the [DSK ON] button is “On”, the [DSK ON] button remains “On” even when the [KEY ON] button is set to “On”. • When the [DSK ON] button is “Off”, the [DSK ON] button remains “Off” even when the [KEY ON] button is set to “Off”. • There is no link with the auto transition operation initiated by setting the [AUTO] button to “On” when the [KEY] button has been selected.
PinP1	<p>This links the “On” or “Off” setting of the [PinP1 ON] button with the “On” or “Off” setting of the [KEY ON] button.</p> <ul style="list-style-type: none"> • When the [PinP1 ON] button is “On”, the [PinP1 ON] button remains “On” even when the [KEY ON] button is set to “On”. • When the [PinP1 ON] button is “Off”, the [PinP1 ON] button remains “Off” even when the [KEY ON] button is set to “Off”. • There is no link with the auto transition operation initiated by setting the [AUTO] button to “On” when the [KEY] button has been selected.

PinP2	<p>This links the “On” or “Off” setting of the [PinP2 ON] button with the “On” or “Off” setting of the [KEY ON] button.</p> <ul style="list-style-type: none"> • When the [PinP2 ON] button is “On”, the [PinP2 ON] button remains “On” even when the [KEY ON] button is set to “On”. • When the [PinP2 ON] button is “Off”, the [PinP2 ON] button remains “Off” even when the [KEY ON] button is set to “Off”. • There is no link with the auto transition operation initiated by setting the [AUTO] button to “On” when the [KEY] button has been selected.
PinP1/2	<p>This links the “On” or “Off” settings of the [PinP1 ON] button and [PinP2 ON] button with the “On” or “Off” setting of the [KEY ON] button.</p> <ul style="list-style-type: none"> • When the [PinP1 ON] button and [PinP2 ON] button are “On”, the [PinP1 ON] button and [PinP2 ON] button remain “On” even when the [KEY ON] button is set to “On”. • When the [PinP1 ON] button and [PinP2 ON] button are “Off”, the [PinP1 ON] button and [PinP2 ON] button remain “Off” even when the [KEY ON] button is set to “Off”. • There is no link with the auto transition operation initiated by setting the [AUTO] button to “On” when the [KEY] button has been selected.

1. Basic operations

1-7. FTB (Fade to Black)

The user can fade out from a program image to the black screen or fade in to a program image from a black screen.

- ① Set the duration of the transition.
Press the **TIME** button to light its indicator, and display the Time menu.
- ② Use [F1] to display the FTB sub menu.
As with a background transition, set the transition time.
Refer to “1-1-6. Auto transition”.

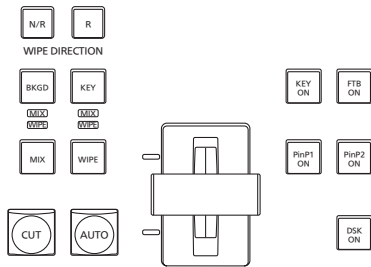

- ③ When the [FTB ON] button in the transition area is pressed, fade-out to the black screen is initiated for the length of the transition time that has been set.

During fade-out, the indicator of the [FTB ON] button blinks in red, and it lights in red when the transition (fade-out) is completed, and the black screen is displayed.*1

When the [FTB ON] button is pressed with the black screen displayed, fade-in to the program image is initiated.

During fade-in, the indicator of the [FTB ON] button lights in red, and it goes off when the transition (fade-in) is completed.

If the [FTB ON] button is pressed at any point during a transition, the direction of the transition is reversed.

*1: In the FTB status, the crosspoint button which is normally lit in red lights in amber.

Selecting the image

The image to be used for fading out can be selected.

- ① Press the **CONFIG SYS** button to light its indicator, and display the Config menu.

- ② Use [F1] to display the Assign sub menu.



- ③ Use [F2] to select the image to appear when fading out using the FTB Source item.

Still1	The still image video memory (Still1) is used.
Still2	The still image video memory (Still2) is used.
Clip1	The moving image video memory (Clip1) is used.
Clip2	The moving image video memory (Clip2) is used.
CBGD1	The color background is used.
CBGD2	
White	White background
Black	Black background

- If a setting other than “White” or “Black” has been selected using the FTB Source item, the corresponding crosspoint button will light in red in the FTB status.

1. Basic operations

1-8. Internal color signals

This unit supports two sets of internal color signals.

1-8-1. Setting the color background

The color background to be used by the bus can be set. Two methods are available: under one method the Hue (hue), Sat (color saturation) and Lum (luminance) are set, and under the other the 8 preset colors (white, yellow, cyan, green, magenta, red, blue and black) are called.

The Hue, Sat and Lum of the called colors can also be adjusted.

Adjusting the colors

- ① Press the  button to light its indicator, and display the Color Background menu.
- ② Use [F1] to display the CBGD1 Main sub menu (or CBGD2 Main sub menu).



- ③ Use [F2], [F3] and [F4] to perform the color adjustments (Hue, Sat and Lum).

■ To call the preset color

Use [F5] to select the preset color using the Load item, and press the [F5].

- When [F5] is pressed, what has been set so far is canceled and replaced with the preset color values.
- To save the values that were set before calling the preset color, refer to “1-10. Memory”.

1-8-2. Setting the Wash effect

The gradation effect for color backgrounds can be set.

Selecting the Wash effect and setting the colors

- ① Press the  button to light its indicator, and display the Color Background menu.
- ② Use [F1] to display the CBGD1 Wash sub menu (or CBGD2 Wash sub menu).

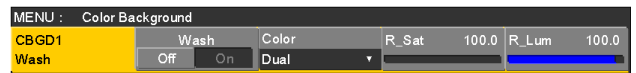

- ③ Use [F2] to set the Wash (gradation) effect using the Wash item.

On	The gradation effect is added.
Off	The gradation effect is not added.

- ④ Use [F3] to set the color of the Wash (gradation) effect using the Color item.

Dual	A dual-color gradation effect is added. (This results in a gradation of two colors, namely, the CBGD1 Main color and the CBGD1 Sub color.)
Rainbow	The rainbow color gradation effect is added.

- ⑤ When “Dual” has been selected, use [F1] to display the CBGD1 Sub sub menu (or CBGD2 Sub sub menu), and set the sub color.



- ⑥ Use [F2], [F3] and [F4] to adjust the colors (Hue, Sat and Lum).

1. Basic operations

Adjusting the Wash waveforms

- ① On the Color Background menu, use [F1] to display the CBGD1 Wave sub menu (or CBGD2 Wave sub menu).



- ② Use [F2] to select the gradation waveforms using the Pattern item.

Sine	Sine waves are selected.
Saw	Sawtooth waves are selected.

- ③ Use [F3] to select the gradation cycle using the Cycle item.
- ④ Use [F4] to select the gradation phase using the Phase item.
- ⑤ Use [F5] to select the gradation angle using the Angle item.

Setting the Wash movements

- ① On the Color Background menu, use [F1] to display the CBGD1 Move sub menu (or CBGD2 Move sub menu).

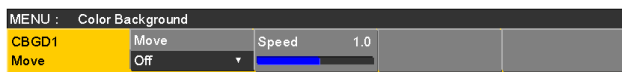

- ② Use [F2] to set the gradation movement using the Move item.

Off	No movement is set.
Roll	The gradations are scrolled.
Rotation	The gradations are rotated.

- ③ Use [F3] to set the movement speed using the Speed item.

1. Basic operations

1-9. Switching the AUX output

1-9-1. Selecting the AUX output materials

The output signals of the AUX buses (AUX1 to AUX4) can be selected.

- ① Press one of the [AUX1] to [AUX4] buttons among the AUX bus selector buttons.
The selected button lights in amber.
- ② Press one of the AUX bus crosspoint buttons.
The selected signal is output to the pressed [AUX1] to [AUX4] button.

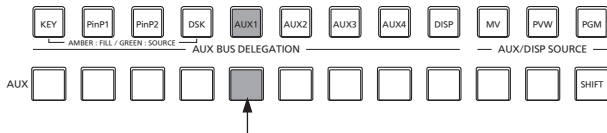

<Signals that can be selected by the AUX bus>

Name of signal	Description of signal
SDI IN1 to 8	SDI input signal 1 to 8
DVI IN	DVI-D input signal
INPUT A1, INPUT A2, INPUT B1, INPUT B2	Input signal A1, Input signal A2, Input signal B1, Input signal B2
PGM	Program video signal
PVW	Preview video signal
CLN	Clean signal
MV	Multi view display output signal
KeyOut	Key output signal
CBGD1, CBGD2	Color background 1, 2
CBAR	Color bar
Still1, Still2	Video memory (still image) 1, 2
Clip1, Clip2	Video memory (moving image) 1, 2
MEM-PVW	Memory preview video signals

- When the AUX bus for which “MV” has been selected is displayed on the sub screen of the multi view display, the images are looped as if two mirrors were facing each other.

1-9-2. AUX1 transitions

The MIX transition is executed when the output signal set for AUX1 is switched.

- ① Press the [AUX1] button of the AUX bus selector buttons.
The selected button and its corresponding AUX bus crosspoint button light in amber.
- ② Press the AUX bus crosspoint button for the output signal to be switched to.
The MIX transition is now initiated for the length of the transition time that was set using the Time menu. While the transition is underway, the transition source AUX button lights in green, and the transition destination AUX button blinks in amber. As soon as the transition is completed, the transition source AUX button goes off, and the transition destination AUX button lights in amber. Furthermore, when another signal is selected at a midway point through a transition, the transition processing continues from that midway point.

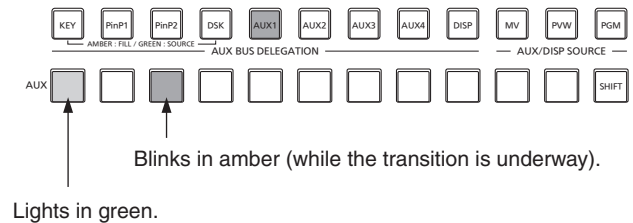

1. Basic operations

1-9-3. Setting enable/disable for the AUX1 transition

The AUX1 transition time and transition enable/disable can be set.

- ① Press the  button to light its indicator, and display the Time menu.
- ② Use [F1] to display the AUX1 BUS Trans sub menu.

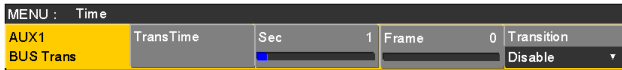

- ③ When the transition time is to be set in frame units, use [F4] for the setting.
- ④ When the transition time is to be set in second units, use [F3] to set the seconds and [F4] to set the frames. Any time from 0 to 999f can be set. The time which can be set when seconds are used as the display unit differs depending on the system format.

59.94i:	max. 33s09f	59.94p:	max. 16s39f
50i:	max. 39s24f	50p:	max. 19s49f
24PsF:	max. 41s15f	23.98PsF:	max. 41s15f

- ⑤ Use [F5] to set enable or disable for the transition using the Transition item.

Enable	Enable
Disable	Disable

When disable has been set for the transition, the output signals are switched with no transition when the output signals set in AUX1 is switched.

1. Basic operations

1-10. Memory

■ Shot memories

The background transition pattern, PinP size, border width and other video effects can be registered in the memory and recalled. The memory used for this is referred to as a shot memory.

By setting effect dissolve, it is possible to ensure a smooth change of the switching from the current images to the images or operations registered in the shot memory.

■ Event memories

A multiple number of the video effects which can be registered in the shot memory can be registered and continuously played back while the current event and next event are interpolated to achieve the effect of a smooth transition. A group of these events are referred to as an event memory. Up to 64 events can be registered in one event memory.

- When operations such as playing are performed on event memories with a different system format to when the event memories were recorded, the operations will not be performed correctly.

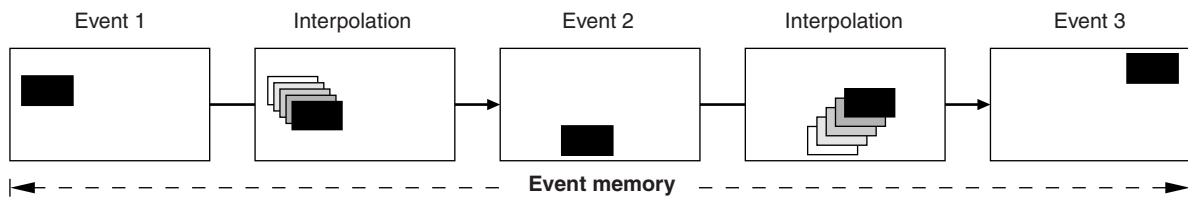





Up to a hundred shot memories and a hundred event memories can be registered.

The related operations are performed using the number keys.

Page 1 to page 10 can be specified for the page numbers of the memories.

Numbers 1 to 10 can be specified as the respective memory numbers for the specified page numbers.

Selecting the memory numbers

- ① Press the [SHOT MEM] or [EVENT MEM] button of the memory to be selected.
- ② Press the  button.
 - The  button indicator lights up, and the mode for specifying the memory page number is established.
 - The number key of the currently selected page lights in amber.
 - The number keys of the page numbers in which more than one memory is registered light in green.
 - The indicators of the number keys of page numbers in which no memories have been registered remain extinguished.
- ③ Press the number key (1 to 10) of the page number.
 - When the page number is determined, the  button indicator goes off, and the mode for specifying the memory number is established.
 - If the page number is not going to be changed, press the  button to turn off its indicator instead of pressing the number key. This establishes the mode for specifying the memory number.
- ④ Press the number key (1 to 10) corresponding to the memory number.
(Hold down the number key when specifying a memory number to register or delete the memory.)

1. Basic operations

1-10-1. Memory registration and recall items

Applicable bus	Material selection	Transition	Pattern	Menu
BKGD	<ul style="list-style-type: none"> • PGM/A bus • PST/B bus 	<ul style="list-style-type: none"> • Fader amount • Wipe direction 	<ul style="list-style-type: none"> • BKGD patterns (MIX, WIPE) 	<ul style="list-style-type: none"> • Background • Color Background
Key	<ul style="list-style-type: none"> • Key Fill bus • Key Source bus 	<ul style="list-style-type: none"> • Fader amount • Wipe direction 	<ul style="list-style-type: none"> • KEY patterns (MIX, WIPE) 	<ul style="list-style-type: none"> • Key • Chroma Key
PinP1	<ul style="list-style-type: none"> • PinP1 bus 	<ul style="list-style-type: none"> • PinP1 ON/OFF 		<ul style="list-style-type: none"> • PinP1
PinP2	<ul style="list-style-type: none"> • PinP2 bus 	<ul style="list-style-type: none"> • PinP2 ON/OFF 		<ul style="list-style-type: none"> • PinP2

1-10-2. Storing the settings in the memory (Store)

Images and operations to be registered can be set and then registered in the memories.

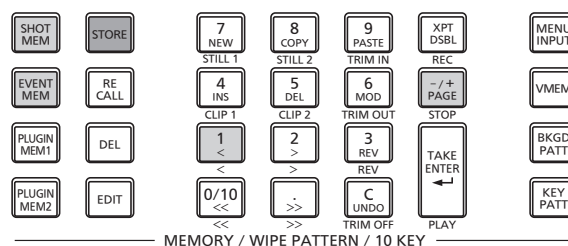



- ① Using the unit, set the images or operations to be kept in the memory.
- ② Press the [SHOT MEM] or [EVENT MEM] button of the memory in which the images or operations are to be registered.
Depending on the operation that was performed last, the [STORE] button, [RECALL] button, [DEL] button or [EDIT] button lights.
- ③ Select the bus (BKGD, KEY, PinP1 or PinP2) to be registered in the memory.
From the Shot Memory menu (or Event Memory menu), select the Store Select sub menu, and then select "On".
☞ Refer to "1-10-1. Memory registration and recall items" and "1-10-6. Selecting the buses whose settings are to be registered and or played back".
- ④ When registering the BKGD (PGM/A or PST/B bus), KEY bus, PinP1 bus or PinP2 bus, set whether the "Material selection" item is to be stored.
From the Shot Memory menu (or Event Memory menu), select the XPT Disable sub menu, and then select "Off".
☞ Refer to "1-10-1. Memory registration and recall items" and "1-10-7. Registering the material selection items".
- ⑤ Press the [STORE] button.
The [STORE] button indicator lights up, and the operations of other memory buttons — [EVENT MEM] (or [SHOT MEM]), [PLUGIN MEM1] and [PLUGIN MEM2] — no longer take effect.
- ⑥ Press the  button, and press the number key (1 to 10) corresponding to the page number.
- ⑦ Hold down (for 2 seconds or so) the number key (1 to 10) corresponding to the number of the memory to be registered.
When the registration is completed, the number key corresponding to the memory number lights in green.
 - The number keys whose indicators are lit in green have memories already registered in them. Delete the memory corresponding to the number key concerned, and register the new memory.
- ⑧ Repeat the above steps to register other kinds of settings in the memories.

1. Basic operations

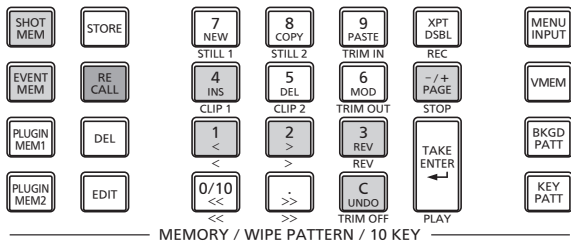
1-10-3. Recalling the operations stored in the memory (Recall)



- ① Press the [SHOT MEM] or [EVENT MEM] button of the memory whose operations are to be recalled. Depending on the operation that was performed last, the [STORE] button, [RECALL] button, [DEL] button or [EDIT] button lights.
- ② Select the bus (BKGD, KEY, PinP1 or PinP2) to be recalled from the memory. From the Shot Memory menu (or Event Memory menu), select the Recall Select sub menu, and then select “On”.
 ☞ Refer to “1-10-6. Selecting the buses whose settings are to be registered and or played back”.
- ③ When selecting materials using the crosspoint buttons on the operation panel instead of using the registered “Material selection” item materials, press the [XPT DSBL] button to light its indicator in red.
 ☞ Refer to “1-10-1. Memory registration and recall items”.
- ④ Press the [RECALL] button. The [RECALL] button indicator lights up, and the number key in which the memory is registered lights in green. The operations of other memory buttons — [EVENT MEM] (or [SHOT MEM]), [PLUGIN MEM1] and [PLUGIN MEM2] — no longer take effect.
- ⑤ Press the  button, and press the number key (1 to 10) corresponding to the page number.

- ⑥ Press the number key (1 to 10) corresponding to the number for the memory whose operations are to be recalled.
 - In the case of a shot memory, the video effects are recalled, and playback starts. During playback, the number key corresponding to the memory number blinks in green.
 - In the case of an event memory, the events are recalled, and playback starts. During playback, the number key corresponding to the memory number blinks in green. If there is a PAUSE event, playback pauses at that event, and the number key corresponding to the memory number blinks in amber. Each time the number key corresponding to the memory number is pressed, playback or pause is selected alternately, and this selection is repeated.
- ⑦ When playback of the effects or events in the recalled memory number starts, the  button is enabled, and its indicator lights up. If this button is pressed during playback, playback is terminated.

1. Basic operations

1-10-4. Memory preview

The video effects in the shot memory or event memory can be output to the program signals after checking them using the memory preview bus (MEM-PVW).

- ① Press the  button to light its indicator, and display the Shot Memory menu (or Event Memory menu).
- ② Use [F1] to display the MEM PVW sub menu.



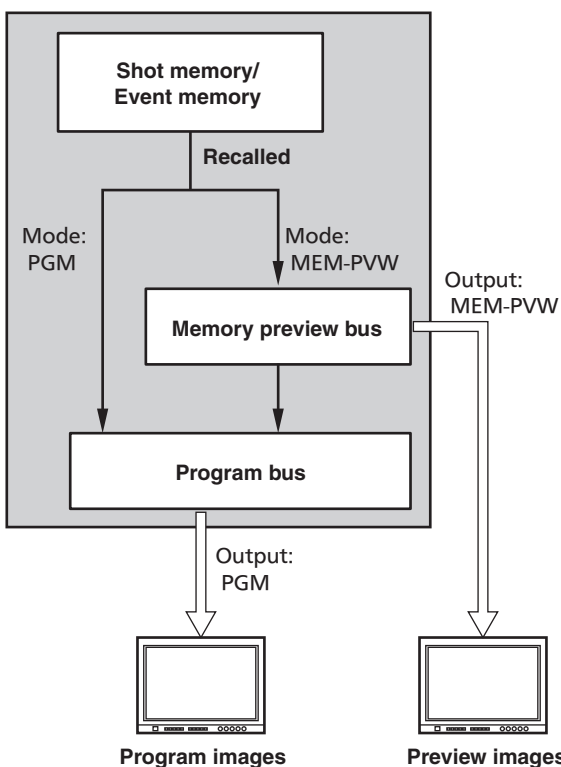

- ③ Use [F2] to select "MEM-PVW" using the Mode item.

PGM	The video effects are output to the program signals.
MEM-PVW	The video effects are first output to the memory preview bus (MEM-PVW) and then output to the program signals.



- The resolution of the images output from the memories is lower than normal.

Memory recall



- ① Press the [SHOT MEM] or [EVENT MEM] button of the memory whose video effects are to be recalled to select the memory.
(Press the button of the memory with the video effects for preview playback.)
Depending on the operation performed last, the indicator of the [STORE] button, [RECALL] button, [DEL] button or [EDIT] button lights up.
- ② Select the bus (BKGD, Key, PinP1 or PinP2) to be recalled from the memory.
From the Shot Memory menu (or Event Memory menu), select the Recall Select sub menu, and then select "On" or "Off".
 Refer to "1-10-6. Selecting the buses whose settings are to be registered and or played back".
- ③ When selecting materials using the crosspoint buttons on the operation panel instead of using the registered "Material selection" item materials, press the [XPT DSBL] button to light its indicator in red.
 Refer to "1-10-1. Memory registration and recall items".
- ④ Press the [RECALL] button.
The [RECALL] button indicator lights up, and the number key in which the memory is registered lights in green.
The operations of other memory buttons — [EVENT MEM] (or [SHOT MEM]), [PLUGIN MEM1] and [PLUGIN MEM2] — no longer take effect.
- ⑤ Press the  button, and press the number key (1 to 10) corresponding to the page number.

Preview playback (output to the memory preview signals)



- ⑥ Press the number key (1 to 10) corresponding to the number for the preview playback memory.
The preview images are output to the memory preview bus (MEM-PVW).
 - During preview playback, the number key corresponding to the memory number blinks in green.
 - If there is a PAUSE event, preview playback pauses at that event, and the number key corresponding to the memory number blinks in amber.
Each time the number key corresponding to the memory number is pressed, preview playback or pause is selected alternately, and this selection is repeated.
 - When preview playback is completed, the indicators of the number key corresponding to the memory number and [TAKE/ENTER] button light in amber.
If the number key corresponding to the memory number is now pressed again, preview playback resumes.



1. Basic operations

Program output (output to the program signals)

- ⑦ For program output, press the [TAKE/ENTER] button.
- During output, the [TAKE/ENTER] button indicator blinks in green.
 - In the case of an event memory which contains a PAUSE event, the output pauses at that event, and the [TAKE/ENTER] button indicator blinks in amber. To resume the output, press the [TAKE/ENTER] button. Each time the [TAKE/ENTER] button is pressed, output or pause is selected alternately, and this selection is repeated.
 - When output is completed, the [TAKE/ENTER] button indicators lights in amber.
- ⑧ When program output is started, the  button takes effect, and its indicator lights up. If the  button is pressed during output, playback is terminated.



<Button lighting statuses>

During preview playback			
Button	During playback	Pause	Stop
Number key corresponding to memory numbers	Blinks (in green)	Blinks (in amber)	Lights (in amber)
	—	—	Lights (in amber)
	—	—	—

During program output			
Button	During output	Pause	Stop
Number key corresponding to memory numbers	Blinks (in green)	Blinks (in amber)	Lights (in amber)
	Blinks (in green)	Blinks (in amber)	Lights (in amber)
	Lights (in amber)	—	—

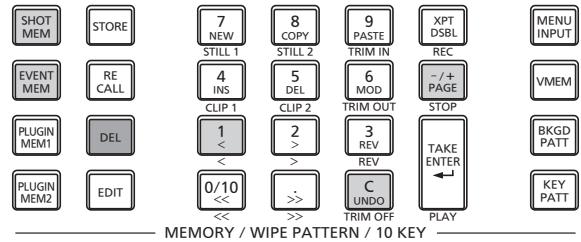
1-10-5. Deleting the operations stored in the memory (Delete)



- ① Press the [SHOT MEM] or [EVENT MEM] button of the memory whose operations are to be deleted to select the memory. The selected button lights in amber. Depending on the operation that was performed last, the [STORE] button, [RECALL] button, [DEL] button or [EDIT] button lights.
- ② Press the [DEL] button. The [DEL] button lights in red. The button of the number key containing the stored operations lights in green.
 - To change a page number, press the  button, and press the number key (1 to 10) corresponding to the page number. Next, press the number key (1 to 10) corresponding to the number of the memory whose operations are to be deleted.
- ③ Hold down (for 2 seconds or so) the number key (1 to 10) corresponding to the number of the memory whose operations are to be deleted. The button of the pressed number key goes off.
- ④ As soon as the stored operations are deleted, the  button becomes operable and lights.
 - If the button is pressed while the  button indicator is lit and the button was operable, the operation performed last is canceled.

1. Basic operations

1-10-6. Selecting the buses whose settings are to be registered and or played back

Selecting the buses for registering memories

Select the bus used for registering shot memories and event memories.

- ① Press the  button to light its indicator, and display the Shot Memory menu (or Event Memory menu).
- ② Use [F1] to display the Store Select sub menu.



- ③ Use [F2] to set the BKGD item, [F3] to set the Key item, [F4] to set the PinP1 item, and [F5] to set the PinP2 item.

On	The bus settings are registered in the memories.
Off	The bus settings are not registered in the memories.

Selecting the buses for playing back memory settings

Select the bus used for playing back shot memory or event memory settings.

When the memory is played back, the settings of the registered bus are played back.

- ① Press the  button to light its indicator, and display the Shot Memory menu (or Event Memory menu).
- ② Use [F1] to display the Recall Select sub menu.



- ③ Use [F2] to set the BKGD item, [F3] to set the Key item, [F4] to set the PinP1 item, and [F5] to set the PinP2 item.

On	The bus settings are played back when the memory is played back. However, they will not be played back if they have not been registered in the memory.
Off	The bus settings are not played back when the memory is played back.

- When the  button is pressed, the Shot Memory menu (or Event Memory menu) appears on the built-in display, and the information of the registered memories appears in the status area on the built-in display. However, the information is not displayed when the [EDIT] button indicator is lit.

<Example of memory information display>

Page: 1 (1 to 10)

No.	Name	EVENT	BKGD		Key		PinP1		PinP2	
			SEL	XPT	SEL	XPT	SEL	XPT	SEL	XPT
1-1	SHOT001	1	On	DSBL	On	DSBL	On	DSBL	On	DSBL
1-2	SHOT002	1	On	DSBL	On	DSBL	On	DSBL	On	DSBL
1-3	SHOT003	1	On	DSBL	On	DSBL	On	DSBL	On	DSBL
1-4	SHOT004	1	On	DSBL	On	DSBL	On	DSBL	On	DSBL
1-5	SHOT005	1	On	DSBL	On	DSBL	On	DSBL	On	DSBL
1-6	SHOT006	1	On	DSBL	On	DSBL	On	DSBL	On	DSBL
1-7	SHOT007	1	On	DSBL	On	DSBL	On	DSBL	On	DSBL
1-8										
1-9										
1-10										

1. Basic operations

1-10-7. Registering the material selection items

Set whether or not to register the “Material selection” items of the buses.

☞ Refer to “1-10-1. Memory registration and recall items”.

- ① Press the  button to light its indicator, and display the Shot Memory menu (or Event Memory menu).
- ② Use [F1] to display the XPT Disable sub menu.



- ③ Use [F2] to set the BKGD item, [F3] to set the Key item, [F4] to set the PinP1 item, and [F5] to set the PinP2 item.

Off	The “Material selection” items are not registered in the memories.
On	The “Material selection” items are registered in the memories.

- When the [XPT DSBL] button is pressed, its indicator lights in red.
The materials of the “Material selection” items registered in the buses are canceled.

1-10-8. Setting effect dissolve (shot memory)

Switching from the current image to the image or operation stored in the shot memory can be performed smoothly.

- ① Press the  button to light its indicator, and display the Shot Memory menu.
- ② Use [F1] to display the Path sub menu.

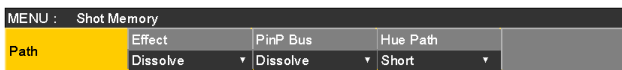

- ③ Use [F2] to set the effect used for switching the images using the Effect item.

Dissolve	The images are switched using the dissolve effect.
Cut	The images are switched using the cut effect.

- The dissolve effect duration is set in the Effect Dissolve sub menu which is selected in the Time menu.

- ④ Use [F3] to set the PinP bus transition using the PinP Bus item.

Dissolve	The PinP bus images are switched using the dissolve effect.
Cut	The PinP bus images are switched using the cut effect.

- ⑤ Use [F4] to select the effect used for switching the colors using the Hue Path item.
The following colors are targeted by Hue.

- Colors of the color background
- Colors of the borders
- Colors of the edges
- Colors of the fill matte

Short	The colors are changed toward less hue on the vectorscope.
Long	The colors are changed toward more hue on the vectorscope.
CW	The Hue is changed clockwise on the vectorscope.
CCW	The Hue is changed counterclockwise on the vectorscope.

- Pressed number keys blink in green while the operation switching is underway.
- When the operation switching has been completed, the pressed number key lights in amber.
- When the Effect item is changed from “Dissolve” to “Cut” while operation is being switched, the dissolve effect is released, and the images are switched to the images of the selected shot memory in an instant.
- When the PinP Bus item is changed from “Dissolve” to “Cut” while operation is being switched, the dissolve effect is released, and the PinP images are instantly switched to the PinP images of the selected shot memory.
- During the operation switching, the operation of the fader lever is canceled.
- During the operation switching, other stored operations cannot be recalled.
- When initiating PinP1/2 transitions, the switching process is not stored in the memory.

1. Basic operations

1-10-9. Editing event memory timelines

Insertion or modification of the events can be edited on the timelines.

■ Timeline

A timeline is a succession of events in the event memories which have been joined together on the time axis.

■ Event points and edit points

On a timeline, the position where an event has been registered is called the event point, and the event currently being edited is called the current event memory.

When there is an edit point between one event point and another, the event point before the edit point serves as the current event memory.

(Event "n" in the figure below)

<Event points and edit points>

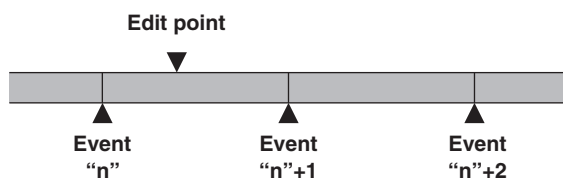

■ Event duration and total duration

The length of time as far as the next event is called the event duration.

The total of all the event durations is called the total duration. The present point in time on the timeline is called the current time.

<How times are referred to>

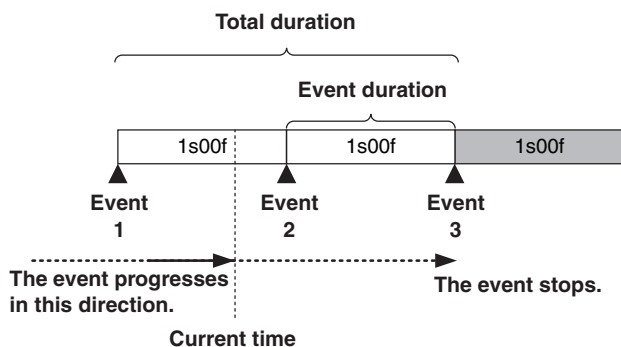

Timeline editing flow

■ Modifying registered event memories

- ① Press the [EVENT MEM] button and light its indicator.

[EVENT MEM] button

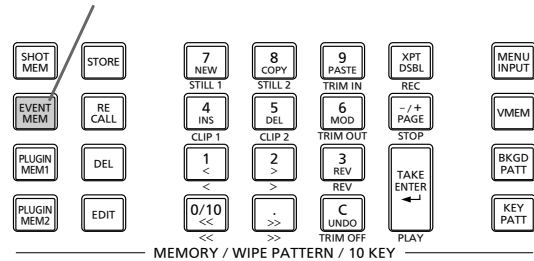

- ② Press the [RECALL] button to light its indicator, and use the [PAGE] button and number keys (1 to 10) to select the event memory to be modified.

☞ Refer to "1-10-3. Recalling the operations stored in the memory (Recall)".

- ③ Press the [EDIT] button to establish the editing mode. (At this point, the timeline of the selected event memory is copied into the work area.)

The timeline appears on the built-in display, and events can be inserted or modified.

- ④ Edit the timeline, and check what has been edited.

☞ Refer to the operations described later.

- ⑤ Register the event memory which has been modified.

☞ Refer to "1-10-2. Storing the settings in the memory (Store)".

■ Creating a new timeline

When this operation is performed, the timeline currently in the work area is deleted.

If it is required, register it in the event memory.

- ① Press the [EVENT MEM] button and light its indicator.

- ② Press the [EDIT] button to light its indicator, and press [7 NEW].

- ③ Create the new timeline.

☞ Refer to the operations described later.

- ④ Register the event memory which has just been created.

☞ Refer to "1-10-2. Storing the settings in the memory (Store)".

The timeline is edited in the work area.

After editing is completed, be absolutely sure to register which has been edited.

1. Basic operations

Setting the playback method

■ Setting the playback mode

- 1 Press the [EVENT MEM] button and light its indicator.

[EVENT MEM] button

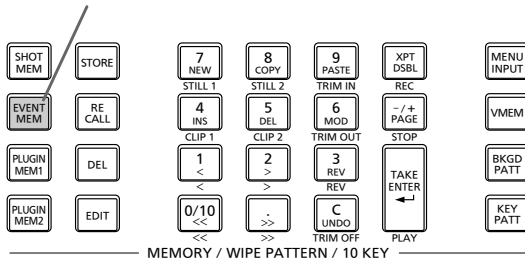

- 2 Press the [EDIT] button to establish the editing mode.
- 3 Press the [SHOT EVENT] button to display the Event Memory menu.
- 4 Use [F1] to display the Run sub menu.



- 5 Use [F2] to set the playback mode using the Run Mode item.

Repeat	During normal playback, playback stops at the last event, and if the [TAKE ENTER] button is now pressed, the images are played back in the same direction. During reverse playback*, playback stops at the first event, and if the [TAKE ENTER] button is now pressed, the images are played back in the same direction.
Loop	During normal playback, playback returns instantly from the last event to the first event, and what has been played back is repeated. During reverse playback*, playback returns instantly from the first event to the last event, and what has been played back is repeated.

*: This function can be actuated in any model whose system version is V2.00.00 and up. Reverse playback cannot be performed in a model with a system version of below V2.00.00.

■ Setting the display mode

- 1 Press the [SHOT EVENT] button to display the Event Memory menu.
- 2 Use [F1] to display the Timeline sub menu.



- 3 Use [F2] to set the timeline display mode using the View item.

Normal	The timeline is displayed in a size which is one-half of the width of the built-in display screen.
Wide	The timeline is displayed in the full size (as large as the entire width) of the built-in display screen.

1. Basic operations

<Timeline displays (on the built-in display)>

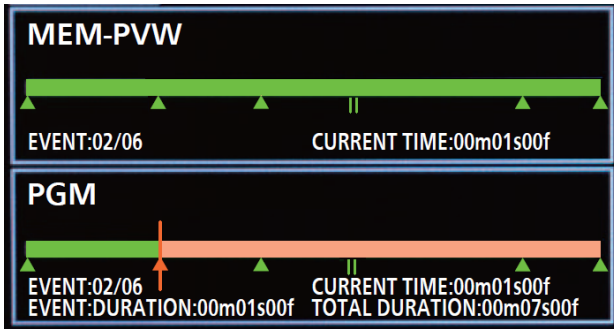

A green “△” below the timeline indicates an event point.

A green “||” indicates that “PAUSE” has been set for an event point.

If an edit point is over an event point, “△” or “||” for the event point is indicated in amber.

When “CLIP” (Clip1, Clip2) has been registered in an event, “▶” appears above the event point.

Similarly, when “GPI-Out” (GPI-O1 to GPI-O19) has been registered in an event, “◀” appears above the event point.

The timeline axis is indicated in green from the start event to the end event.

During playback, the part from the beginning to the current position is indicated in red.

Similarly, during reverse playback, the part from the end to the current position is indicated in red.

■ Number key operations

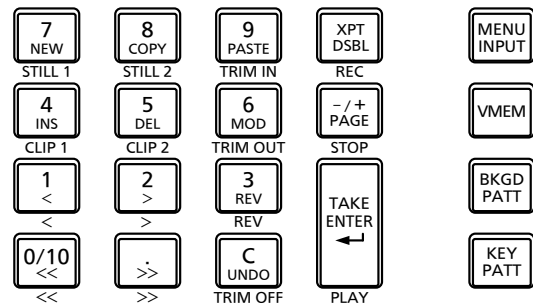

MEMORY / WIPE PATTERN / 10 KEY

	Creates a new timeline.
	Copies events. An event is not copied if an edit point is not over the event.
	Pastes the copied events. If the edit point is an event point, the event is inserted after the event point. If the edit point is at any midway position in an event, the event is inserted at the edit point.
	Inserts events. If the edit point is an event point, the event is inserted after the event point. If the edit point is at any midway position in an event, the event is inserted at the edit point.
	Deletes events.
	Modifies events. This key cannot be operated if the edit point is not over the event point.
	Moves to the start event point.
	Moves to the end event point.
	Moves to the next event point.
	Moves to the previous event point.
	Reverses the playback direction (event numbers are put in their reverse sequence).
	Undoes the editing operation of the event. When the button is pressed, the operation performed last is canceled.
	Plays back events. When this button is operational, its indicator lights in amber. Each time it is pressed, operation is switched between playback and pause. During playback, its indicator blinks in green; during pause, it blinks in amber.

1. Basic operations

Inserting events (Insert)

The current setting status can be inserted as an event after the current event memory.

When an event is inserted, the numbers of the events after the current event memory are each moved up by one.

- ① Use , , and to select the event point (current event memory) which is to be inserted.
To insert the event at a midway point of an event, play back the event to the place where the event is to be inserted, and stop the edit point.
- ② Operate the panel, and create the event.
- ③ Press to insert the created event.
To cancel the event insertion, press the button.
 - When the number of events on the timeline has reached 64, no further events can be inserted.
 - When the edit point is over the event point, the newly created event is inserted with the same duration as the current event memory.
 - If the edit point is between one event point and another, the current event memory is split at the edit point position, and the newly created event is inserted.

Modifying events (Modify)

Already registered events can be modified.

- ① Use , , and to select the event point of the event to be modified.
- ② Operate the panel, and modify the event.
- ③ Press to enter what has been modified.
To cancel the event modification, press the button.

Copying events (Copy)

Already registered events can be copied.

- ① Use , , and to select the event point of the event to be copied.
- ② Press to copy the event.

Pasting events (Paste)

Copied events can be pasted.

- ① Use , , and to select the event point where the copied event is to be inserted.
To insert the copied event between one event point and another, play back the event to the place where the copied event is to be inserted, and stop the playback.
- ② Press to paste the copied event.
To cancel the event pasting, press the button.
 - When the number of events on the timeline has reached 64, no further events can be inserted.
 - When the edit point is over an event point, the copied event is inserted with the same duration as the current event memory.
 - If the edit point is between one event point and another, the current event memory is split at the edit point position, and the copied event is inserted.

Deleting events (Delete)

Already registered events can be deleted.

- ① Use , , and to select the event point of the event to be deleted.
- ② Press to delete the event.
To cancel the event deletion, press the button.
 - Even if the edit point is midway through an event, the current event memory will be deleted.

Undoing what has been edited (Undo)

When the button is pressed, the operation performed last is canceled.

1. Basic operations

Setting events using the menus

■ Registering marks

Marks can be registered and events inserted at the event points.

- Pause
- Clip playback
- GPI-Out output

① Use $\left[\frac{0/10}{\ll} \right]$, $\left[\frac{1}{\lt} \right]$, $\left[\frac{2}{\gt} \right]$ and $\left[\frac{\gg}{\gt} \right]$ to select the event where the mark is to be registered or the event inserted.

② Press the $\left[\frac{\text{SHOT}}{\text{EVENT}} \right]$ button to display the Event Memory menu.

③ Use [F1] to display the Mark sub menu.

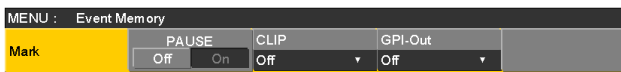

④ Use [F2] (PAUSE item), [F3] (CLIP item) or [F4] (GPI-Out item) to select the item.

PAUSE	When "On" is selected and the mark is registered in the event point, playback is paused at the mark position during event playback. "II" appears above the timeline.
CLIP	When "Clip1" or "Clip2" is selected and the mark is registered in the event point, the clip is played back at the mark position during event playback. "▶" appears above the timeline.
GPI-Out	When a GPI output port from "GPI-O1" to "GPI-O19" is selected and the mark is registered in the event point, pulse signals are output from the GPI Output port at the mark position during event playback. "⚡" appears above the timeline. • For the Config menu → GPI-Out Port 1/5 sub menu to GPI-Out Port 5/5 sub menu → Assign item, check that the selected GPI output port is set to "Event MEM".

⑤ Press $\left[\frac{6}{\text{MOD}} \right]$ to register the mark.
In addition, press $\left[\frac{4}{\text{INS}} \right]$ to insert the event.
To cancel the mark registration or event insertion, press the $\left[\frac{\text{C}}{\text{UNDO}} \right]$ button.

■ Setting the event duration

The lengths of the events can be set.

① Use $\left[\frac{0/10}{\ll} \right]$, $\left[\frac{1}{\lt} \right]$, $\left[\frac{2}{\gt} \right]$ and $\left[\frac{\gg}{\gt} \right]$ to select the event to be modified.

② Press the $\left[\frac{\text{SHOT}}{\text{EVENT}} \right]$ button to display the Event Memory menu.

③ Use [F1] to display the Event Duration sub menu.



④ Use [F2] (minute item: minutes), [F3] (second item: seconds) and [F4] (frame item: frames) to set the event length.

⑤ Press [F5] to enter the duration.
To cancel what has been modified, press the $\left[\frac{\text{C}}{\text{UNDO}} \right]$ button.

■ Setting the total duration

The total length of all the events from start to end can be set. When the total duration is changed, the durations of the events contained in the event memories are re-calculated using the duration ratio prior to the change. However, the shortest duration of an event cannot be shorter than one frame.

① Press the [EVENT MEM] button and light its indicator.

② Press the [RECALL] button to light its indicator, and use the $\left[\frac{7}{\text{PAGE}} \right]$ button and number keys (1 to 10) to select the event memory to be modified.
Refer to "1-10-3. Recalling the operations stored in the memory (Recall)".

③ Press the $\left[\frac{\text{SHOT}}{\text{EVENT}} \right]$ button to display the Event Memory menu.

④ Use [F1] to display the Total Duration sub menu.

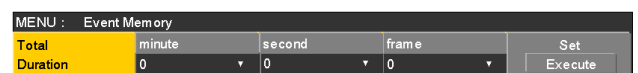

⑤ Use [F2] (minute item: minutes), [F3] (second item: seconds) and [F4] (frame item: frames) to set the event length.

⑥ Press [F5] to enter the duration.

- If no more events can be contained in the total duration which already has many events and which has been changed, the number of frames will be forcibly adjusted.

1. Basic operations

■ Setting the event switching effect (Path)

Switching from one event to another (bus switching) can be accomplished smoothly.

① Press the  button to light its indicator, and display the Event Memory menu.

② Use [F1] to display the Path sub menu.

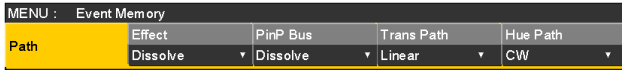

③ Use [F2] to set the effect to be used for switching images using the Effect item.

Dissolve	The images are switched using the dissolve effect.
Cut	The images are switched using the cut effect.

- The dissolve effect duration is set in the Effect Dissolve sub menu which is selected on the Time menu.

④ Use [F3] to set the PinP bus transition using the PinP Bus item.

Dissolve	The PinP bus images are switched using the dissolve effect.
Cut	The PinP bus images are switched using the cut effect.

⑤ Use [F4] to select the path to be used for switching the images using the Trans Path item.

The following transitions are targeted.

- Width of the borders
- Soft effect of the borders
- Colors of the borders
- Positions of the images
- Trimming values

Linear	The switching from one image to another is interpolated linearly.
Step	The parameters are updated when the events are passed through.

⑥ Use [F5] to select the effect when the colors are switched using the Hue Path item.

The following hues are targeted.

- Colors of the color background
- Colors of the borders
- Colors of the edges
- Colors of the fill matte

Short	The colors are changed toward less hue on the vectorscope.
Long	The colors are changed toward more hue on the vectorscope.
CW	The Hue is changed clockwise on the vectorscope.
CCW	The Hue is changed counterclockwise on the vectorscope.
Step	The color changes are updated when an event is passed through.

1. Basic operations

1-10-10. Registering memories (Register)

Shot memories and event memories can be registered. Information on the memories is displayed in the status area of the built-in display, and names can be changed or copied.

- ① Press the  button to light its indicator, and display the Shot Memory menu (or Event Memory menu). The information of the memories is now displayed in the status area of the built-in display.
- ② Use [F1] to display the Register sub menu.

MENU : Shot Memory	Page	No.	Name	Copy To
Register	1	1		1

Changing the names of the memories

The names (up to 16 characters) of the memories can be changed.

- ① On the Register sub menu, use [F2] to select the page number of the registered memories using the Page item.
- ② Use [F3] to select the memory number using the No. item.
- ③ Use [F4] to display the keyboard screen.
- ④ Use [F1] to [F3] to input the name, and press [F4]. To cancel the name which has been input and close the keyboard screen, press [F5].
 Refer to "2-2-2. Keyboard screen operations" (<Basics> Operating Instructions).

Copying memories

Memories can be copied.

To register a copied memory, select a number which has not been registered for any other memory.

- ① On the Register sub menu, use [F2] to select the page number of the registered memories using the Page item.
- ② Use [F3] to select the memory number using the No. item.
- ③ Use [F5] to select the number of the memory to which the memory will be copied, and press [F5].

1. Basic operations

1-11. Video memories

This unit can be used to store still image memories (Still) and moving image memories (Clip), each in two channels.

- Images with key signals can be stored in the video memories (still images and moving images).
- Images of up to 600 frames (20 seconds with the 59.94i format) can be stored in the moving image memories per channel in the standard mode, and images up to 300 frames (10 seconds with the 59.94i format) can be stored in the high-image-quality mode.
- The size of the images (number of seconds) which can be stored depends on the system format (frame rate).
- The video memory data can be stored onto, and read out from, memory cards.

* There are some differences in the operations which can be performed depending on whether the system version of the model is V2.00.00 and up or under V2.00.00.

• Models whose system version is below V2.00.00

Video memory operation		Current status					
		Clip1			Clip2		
		Recording	Playback	Stop	Recording	Playback	Stop
Still1	Recording	—	—	✓	—	—	✓
Still2	Recording	—	—	✓	—	—	✓
Clip1	Recording	/	/	/	—	—	✓
	Playback	/	/	/	—	—	✓
	Stop	/	/	/	✓	✓	✓
Clip2	Recording	—	—	✓	/	/	/
	Playback	—	—	✓	/	/	/
	Stop	✓	✓	✓	/	/	/

✓: Valid
—: Invalid

• Models whose system version is V2.00.00 and up

Video memory operation		Current status					
		Clip1			Clip2		
		Recording	Playback	Stop	Recording	Playback	Stop
Still1	Recording	—	✓	✓	—	✓	✓
Still2	Recording	—	✓	✓	—	✓	✓
Clip1	Recording	/	/	/	—	✓	✓
	Playback	/	/	/	✓	✓	✓
	Stop	/	/	/	✓	✓	✓
Clip2	Recording	—	✓	✓	/	/	/
	Playback	✓	✓	✓	/	/	/
	Stop	✓	✓	✓	/	/	/

✓: Valid
—: Invalid

■ Video memory input/output

The image input materials can be selected from the output signals of the AUX buses (AUX1 to AUX4).

The key materials can be input from the KeyOut output signals.

<Image systems of the video memories>

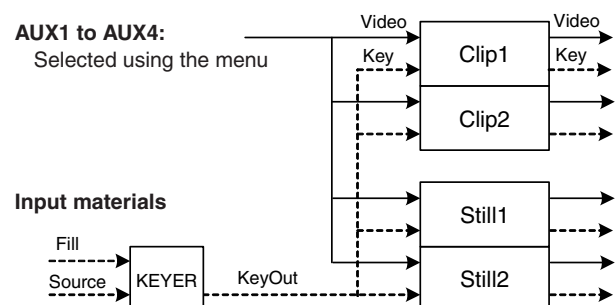

1. Basic operations

1-11-1. Recording still images (Still)

① Press the  button to light its indicator, and display the Video Memory menu.

② Use [F1] to display the Video Memory3 sub menu.

MENU : Video Memory				
Video	Total Time	Current Time	Key	Rec Lock
Memory3	00s01f	00s01f	Off	Off On

③ Use [F5] to select “Off” using the Rec Lock item.

- When the unit’s power has been turned back on after it was turned off, the Rec Lock item setting is restored to “On”.

④ Use [F1] to display the Video Memory1 sub menu.

MENU : Video Memory				
Video	Select	Rec	Play	Stop
Memory1	Still1	Execute	Execute	Execute

⑤ Use [F2] to select “Still1” or “Still2” using the Select item.

⑥ Use [F1] to display the Rec1 sub menu.

MENU : Video Memory				
Rec1	Preview	V Source	Key Enable	Review
	Off On	AUX1	Off On	Off On

⑦ Use [F2] to set the images to appear on the built-in display using the Preview item.

On	The image appearing on the built-in display is forcibly switched to the image to be recorded (AUX1 to AUX4 selected using the V Source item) instead of the material selected by the DISP bus.
Off	The image source selected by the DISP bus is displayed as a preview.

⑧ Use [F3] to set the image to be recorded in the video memory using the V Source item.

AUX1 to AUX4	The output signals of the AUX buses (AUX1 to AUX4) are recorded as the material.
---------------------	----------------------------------------------------------------------------------

⑨ Use [F5] to set the review display using the Review item.

On	After the images have been recorded, the images of the video memory recorded in the AUX bus are displayed (for 2 seconds or so). The next images can be recorded even during review display.
Off	The review display is not shown.

⑩ Use [F1] to display the Video Memory1 sub menu.

MENU : Video Memory				
Video	Select	Rec	Play	Stop
Memory1	Still1	Execute	Execute	Execute

⑪ As soon as [F3] (Rec) is pressed, the still images are recorded.*

*: This function can be actuated in any model whose system version is V2.00.00 and up. These operations cannot be performed in a model with a system version of below V2.00.00.

- If the [V MEM] button on the right of the number keys is pressed and the video memory operation mode has been established, the operation of this button is linked with the [XPT/DSBL] button among the number keys.
- When the recording of the still images is completed, thumbnails of the still images are displayed in the thumbnail screen.

1. Basic operations

1-11-2. Recording moving images (Clip)

① Press the  button to light its indicator, and display the Video Memory menu.

② Use [F1] to display the Video Memory3 sub menu.



③ Use [F5] to select “Off” using the Rec Lock item.

- When the unit’s power has been turned back on after it was turned off, the Rec Lock item setting is restored to “On”.

④ Use [F1] to display the Video Memory1 sub menu.

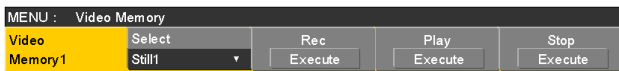

⑤ Use [F2] to select “Clip1” or “Clip2” using the Select item.

⑥ Use [F1] to display the Rec1 sub menu.



⑦ Use [F2] to set the images to appear on the built-in display using the Preview item.

On	The image appearing on the built-in display is forcibly switched to the image to be recorded (AUX1 to AUX4 selected using the V Source item) instead of the material selected by the DISP bus.
Off	The image source selected by the DISP bus is displayed as a preview.

⑧ Use [F3] to set the image to be recorded in the video memory using the V Source item.

AUX1 to AUX4	The output signals of the AUX buses (AUX1 to AUX4) are recorded as the material.
---------------------	----------------------------------------------------------------------------------

⑨ Use [F5] to set the review display using the Review item.

On	After the images have been recorded, the images of the video memory recorded in the AUX bus are displayed (for 2 seconds or so).
Off	The review display is not shown.

⑩ Use [F1] to display the Rec2 sub menu.



⑪ Use [F2] to select the recording repeat setting using the Loop item.

On	The recording of the images is continued until the stop operation is performed. If either of the following operations is performed while recording is in progress, the images are recorded up to the last frame, after which recording stops. <ul style="list-style-type: none"> When “Off” is selected as the Loop item setting. When [Stop] ([F5] of Video Memory sub menu) is pressed.
Off	Images are recorded up to the maximum recording time (set using the Limit items), after which recording stops automatically.

⑫ Use [F3] to set the quality of the images to be recorded using the Quality item.

Standard	Standard image quality Maximum 600 frames (20 seconds with 59.94i format)
High	High image quality Maximum 300 frames (10 seconds with 59.94i format)

⑬ Use [F4] to set the maximum recording time using the Limit item.

⑭ Use [F1] to display the Video Memory1 sub menu.

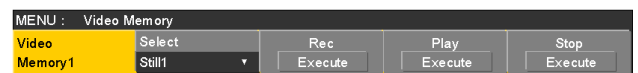

⑮ As soon as [F3] (Rec) is pressed, the recording of the moving images starts.

1. Basic operations

- ⑩ When [F5] (Stop) is pressed, the recording of the moving images is stopped.*

*: This function can be actuated in any model whose system version is V2.00.00 and up. These operations cannot be performed in a model with a system version of below V2.00.00.

- If the [VMEM] button on the right of the number keys is pressed and the video memory operation mode has been established, the operation of this button is linked with the  button among the number keys.
- Thumbnails of moving images are displayed on the thumbnail screen. While the thumbnails are displayed, the following information is also displayed on the thumbnail screen.

Current playback position (time), IN point position, OUT point position

- With the moving images on which the key signals are recorded, a yellow “○” mark is displayed for the thumbnail icons.
- The recording time is displayed in the Total Time item of the Video Memory3 sub menu. Also, “On” is displayed for the Key item when the key signals have been recorded.

1-11-3. Saving Images in Flash Memory *

*: This function can be actuated in any model whose system version is V2.00.00 and up. These operations cannot be performed in a model with a system version of below V2.00.00.

Data for images stored in the video memory can be retained even when the power is turned off, by saving them in the flash memory area.

Whether to automatically save the image data stored in the video memory when the data is transferred from the AUX bus or to manually save them must be set.

Care must be taken when selecting manual saving, as image data stored in the video memory will be lost if the power is turned off before the saving operation is completed.

- ① Press the  button to light its indicator, and display the Video Memory menu.
- ② Use [F1] to display the Memory sub menu.



- ③ Use [F2] to select the saving method using the Mode item.

Auto	Automatic saving
Manual	Manual saving

- ④ Use [F3] to select the video memory for saving data in the flash memory area using the Select item. When “All” has been selected, all the video memories are saved.
- ⑤ Press the [F5] (Save) to save data in the flash memory area.

- The [F5] (Save) becomes enabled when “Manual” is selected in the Mode item.
- When, in the case of the settings below, [Stop] ([F5] of the Video Memory sub menu) is pressed while video memory recording is in progress, the video memories are saved in the flash memory area immediately after [Stop] has been pressed.

- Memory sub menu
“Mode” item: “Auto”
- Rec2 sub menu
“Loop” item: “On”

However, if the power is cut off during recording, the video memories will not be saved in the flash memory area.

1. Basic operations

1-11-4. Playing back moving images (Clip)

Establishing the playback mode

- Press the button to light its indicator, and display the Video Memory menu.
- Use [F1] to display the Clip1 Play Mode sub menu (or Clip2 Play Mode sub menu).



- Use [F2] to select the playback mode using the Mode item.*

*: This function can be actuated in any model whose system version is V2.00.00 and up. These operations cannot be performed in a model with a system version of below V2.00.00.

Lead	Operation returns to the start frame after playback.
Last	Operation stops at the end frame after playback.
Loop	The end frame and start frame are joined together and played back repeatedly.

- Use [F3] to select reverse playback using the Reverse item.*

*: This function can be actuated in any model whose system version is V2.00.00 and up. These operations cannot be performed in a model with a system version of below V2.00.00.

On	The moving images are played back in the reverse direction.
Off	The moving images are played back in the forward direction.

- When the [VMEM] button on the right of the number key is pressed and the video memory operation mode has been established, the operation of this button is linked with the button among the number keys.

- Use [F4] to select the speed for variable speed playback using the Variable item.

Speeds which can be selected:
 $\times 1/8, \times 1/4, \times 1/2, \times 1, \times 2, \times 4, \times 8$

- Use [F5] to select the image when operation is stopped using the Freeze item.

Frame	A frame image is played back.
Field	A field image is played back.

- Use [F1] to display the Trans Sync sub menu.*

*: This function can be actuated in any model whose system version is V2.00.00 and up. These operations cannot be performed in a model with a system version of below V2.00.00.



- Use [F2] and [F3] to set the control button used for playing back moving images in tandem with the transition operation.*
 Use [F2] (Clip1 item) to set the Clip1 playback start button, and use [F3] (Clip2 item) to set the Clip2 playback start button.

*: This function can be actuated in any model whose system version is V2.00.00 and up. These operations cannot be performed in a model with a system version of below V2.00.00.

Off	Playback is not performed in tandem with the transition operation.
KEY ON	The playback of the moving images is started in tandem with the operation of the [KEY ON] button.
PinP1 ON	The playback of the moving images is started in tandem with the operation of the [PinP1 ON] button.
PinP2 ON	The playback of the moving images is started in tandem with the operation of the [PinP2 ON] button.
DSK ON	The playback of the moving images is started in tandem with the operation of the [DSK ON] button.
FTB ON	The playback of the moving images is started in tandem with the operation of the [FTB ON] button.

Playing back the moving images

- Press the button to light its indicator, and display the Video Memory menu.
- Use [F1] to display the Video Memory1 sub menu.

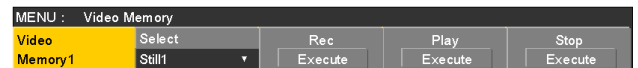

- Use [F2] to select Clip1 or Clip2 using the Select item.
- When [F4] (Play) is pressed, playback of the moving images is started.*

*: This function can be actuated in any model whose system version is V2.00.00 and up. These operations cannot be performed in a model with a system version of below V2.00.00.

- When the [VMEM] button on the right of the number key is pressed and the video memory operation mode has been established, the operation of this button is linked with the [TAKE/ENTER] button among the number keys.
- The current playback position (time) is displayed for the Current Time item on the Video Memory3 sub menu.

1. Basic operations

Moving to the first frame or last frame

- Press the button to light its indicator, and display the Video Memory menu.
- Use [F1] to display the Video Memory2 sub menu.



- When [F2] (LEAD) is pressed, the current position is moved to the first (head) frame; conversely, when [F3] (LAST) is pressed, the current position is moved to the last frame.

- When the [VMEM] button located on the right of the number keys is pressed and the video memory operation mode has been established, the operation of number keys and become linked.*

*: This function can be actuated in any model whose system version is V2.00.00 and up. These operations cannot be performed using the number keys with models whose system version is below V2.00.00.

Trimming moving images

The position where the playback of the moving images is to start (IN point) and the position when it is to end (OUT point) can be set.

- Press the [VMEM] button on the right of the number keys to establish the video memory operation mode.
- Use the number keys to stop the moving images at the position where the images are to be trimmed (IN point or OUT point).
- Trim the moving images by operating the buttons below.

	Sets the trimming IN point.
	Sets the trimming OUT point.
	Releases the trimming settings.

- The trimmed moving images are played back from the IN point to the OUT point, however you can move anywhere in the section from the start point to the end point of the recorded moving images by operating , , and .
- Trimming can be set and released over and over again until the moving images are stored on the memory card.
- When the moving images are saved on an memory card, only the trimmed parts are saved and the parts no longer required are deleted.

Operations performed using the number keys*

*: This function can be actuated in any model whose system version is V2.00.00 and up. These operations cannot be performed using the number keys with models whose system version is below V2.00.00.

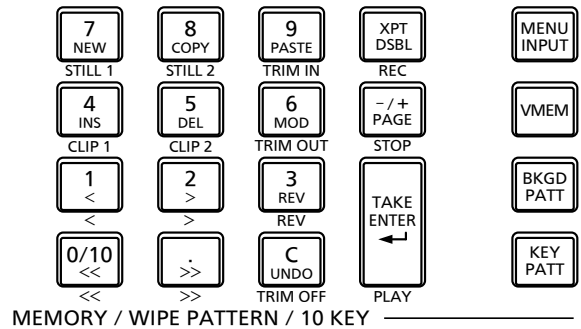

	Selects Still1 as the operation target.
	Selects Still2 as the operation target.
	Selects Clip1 as the operation target.
	Selects Clip2 as the operation target.
	Sets the trimming IN point.
	Sets the trimming OUT point.
	Releases the trimming settings.
	Plays back the moving images one frame at a time in the reverse direction.
	Plays back the moving images one frame at a time in the forward direction.
	Sets the playback direction to reverse. (Button indicator lights: reverse direction; indicator off: forward direction)
	Transfers to the start frame of the moving images, and stops.
	Transfers to the end frame of the moving images, and stops.
	Plays back the moving images.
	Starts recording the moving images.
	Stops the recording or playback of the moving images.

1. Basic operations

Displaying thumbnails*

*: This function can be actuated in any model whose system version is V2.00.00 and up. These operations cannot be performed in a model with a system version of below V2.00.00.

- When the [VMEM] button located on the right of the number keys is pressed and the video memory operation mode has been established, thumbnails of the images registered in the video memories (Still1, Still2, Clip1, Clip2) can be shown on the built-in display.

1. Basic operations

1-12. Memory card

The unit's video memory data and setup data can be stored on memory card.

Conversely, this data can be loaded from the memory card to the unit.

Furthermore, it is possible to upgrade the unit's software.

- It may take a while to store a moving image of a long recording time with high image quality or a still image file with high image quality on the memory card.
(Approximately 10 minutes is necessary when data with total size of about 490 MB stored in "All file" is saved to a Panasonic Class 8 SDHC memory card.)

Video memory (still image data: Still1, Still2):

<File formats supported>

Bitmap (bmp), JPEG (jpg), TARGA (tga), TIFF (tif), GIF (gif), PNG (png)

<Applicable sizes>

HD/1080i:	1920×1080
HD/1080PsF:	1920×1080
HD/720p:	1280×720
SD/NTSC:	720×487
SD/PAL:	720×576

- The size of images is converted automatically if it does not match any of the "applicable sizes".
- The pixels of images in SD format are not square, so the aspect ratio will be different when the images are displayed on the computer and when they are imported into video memory (with NTSC format, they will be vertically long).
To keep the images true to their actual proportions, make sure the original size is 720×540 pixels. If the images are in NTSC format, use images shrunk to 720×487 pixels. If the images are in PAL format, use images enlarged to 720×576 pixels.

Video memories (moving image data: Clip1, Clip2):

This is the original format of the unit.

Data is stored in and read from these memories.

Shot memory data (Shot):

Data is stored in and read from these memories.

Event memory data (Event):

Data is stored in and read from these memories.

Setup data (Set Up):

The "setup data" refers to all the data stored in the unit with the exception of the following data.

The extension used for the setup data files is "h41".

Date, time, network settings, video memory data, shot memory data, event memory data

All file (All):

All the following data is stored.

Video memory data, shot memory data, event memory data, setup data

Plug-in software (Plug-in):

The plug-in software data is loaded.

It cannot be stored.

Software for upgrading (Upgrade):

The software for upgrading is loaded.

This software can be obtained from "Service and Support" on the home page whose address is provided below:

<http://pro-av.panasonic.net/>

For the upgrade procedure, follow the steps in the directions which are contained in the download file.

Log file (Log):

Log files stored in the unit can be saved.

● Concerning memory cards

Memory cards used with the unit should conform to SD or SDHC standards.

Be sure to format cards using the unit.

Memory cards with the following capacity can be used for the unit.

SDXC memory cards are not available for this product.

SD (from 8 MB to 2 GB)

SDHC (from 4 GB to 32 GB)

For the latest information not available in the Operating Instructions, visit the following Web sites.

<http://pro-av.panasonic.net/>

- Memory cards must not be used or stored in an environment where they may be
 - Exposed to high temperatures/humidities;
 - Exposed to water droplets; or
 - Electrically charged.

1. Basic operations

The data is stored in the following folders on the memory card.

When data is to be loaded, first store the data in the respective folders, and then load the files.

<Data folder configuration>

Data type	SELECT item	Storage folder	Extension
Video memory Still image data	Still1, Still2	"HS400\IMAGE"	bmp, jpg, tga, tif, gif, png
Video memory Moving image data	Clip1, Clip2	"HS410\CLIP"	clp
Shot memory data	Shot	"HS410\SHOT"	s41
Event memory data	Event	"HS410\EVENT"	e41
Setup data	Set Up	"HS410\SYSTEM"	h41
All file	All	"HS410\ALL"	— *
Plug-in software	Plug-in	"HS410\PLUGIN"	plg
Software for upgrading	Upgrade	"HS410\SYSTEM"	41d
Log file	Log	"HS410\LOG"	log

*: In the case of "All file", folders with the names specified using the File Name item are created at the hierarchical level under the "ALL" folder, and the data is stored inside the folders which have been created.

The data is stored under the following filenames.

Still1.*, Still2.***, Clip1.clp, Clip2.clp, Shot.s41, Event.e41, Setup.h41**

Memory card handling precautions

- Do NOT eject the memory card while the memory card access LED is lit.
When an memory card is ejected while the memory card access LED is lit, the transition may be temporarily suspended.
In addition, the data stored on the memory card may be lost.
- The data stored on memory cards may be lost as a result of misplacing the cards or performing erroneous operations, for instance. It is recommended that valuable data be stored on a computer or other device.

1. Basic operations

1-12-1. Initializing the memory cards

Before an memory card is used in this unit, **the card must be initialized by the unit without fail.**

By initializing the memory card formats (in compliance with the SD standard) it creates the dedicated directory. (All files saved on the memory card will be erased.)

- ① Insert the memory card into the unit's memory card slot.
- ② Press the  button to light its indicator, and display the SD Card menu.
- ③ Use [F1] to display the File1 sub menu.



- ④ Use [F2] to select "Init" using the Mode item, and then press the [F2].
If the memory card has not been inserted, "No Card" will appear at the Mode item.
- ⑤ Press the [F1] (OK) to initialize the card.

Before using a memory card in this unit, initialize it. This unit also supports SDHC memory cards. Memory cards can be initialized no matter whether they are SD or SDHC memory cards.

1-12-2. Saving data on memory cards

- ① Insert the memory card which has been initialized by the unit, into the memory card slot.
- ② Press the  button to light its indicator, and display the SD Card menu.
- ③ Use [F1] to display the File1 sub menu.



- ④ Use [F2] to select "Save" using the Mode item, and then press the [F2].
- ⑤ Use [F3] to select the data which is to be stored on the memory card using the Save Type item.
The filename provided automatically is displayed in the File Name item.
File names are provided automatically using the running number as shown below.

<Saving the video memories, shot memory data, Event memory data and setup data>

hs001.xxx to hs100.xxx

- When changing a filename, press [F4] to open the keyboard screen, input the filename, and close the keyboard screen.
Refer to "2-2-2. Keyboard screen operations" (<Basics> Operating Instructions).

<Saving the all files and log files>

hs001 to hs100

- The name of the folder where the all files and log files are saved serves as the filenames of the all files and log files.
The filenames of the all files and log files cannot be changed on the keyboard screen.
- ⑥ If the [F5] (Save) is now pressed, the file is stored on the memory card.
For the destinations where the data is stored, refer to <Data folder configuration>.
 - When storing video memory still images, the file format can be selected.
On the SD Card menu, use [F1] to display the File2 sub menu, and select the format of the file to be used when storing the data on the memory card using the Format item.

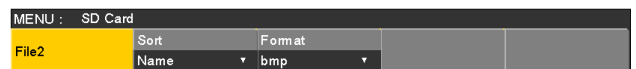

1. Basic operations

1-12-3. Loading data from memory cards

- Insert the memory card on which the data is stored into the memory card slot.
Load the file after its data has been stored in the each folder.
Data stored in other folders will not be recognized by the unit.
For the destinations where the data is stored, refer to <Data folder configuration>.
- On the SD Card menu, use [F1] to display the File1 sub menu.



- Use [F2] to select "Load" using the Mode item, and then press the [F2].
When [F2] is pressed, the file selection screen is displayed.

<Example of what appears on the file selection screen>

FILE NAME	SIZE	TYPE	FRAME	KEY	DATE
hs001.bmp	1920 * 1080	Still	1		12-02-2009 19:38
hs002.bmp	1920 * 1080	Still	1		12-02-2009 19:38
hs003.png	1920 * 1080	Still	1	●	12-02-2009 19:39
hs004.png	1920 * 1080	Still	1	●	12-02-2009 19:40
hs005.jpg	1920 * 1080	Still	1		12-02-2009 19:40
hs006.jpg	1920 * 1080	Still	1		12-02-2009 19:40

F1:SELECT Still1 F2:SELECT FILE F3:LIST VIEW List F4:OK(LOAD) F5:CANCEL

- Use [F1] to select the type of file to be loaded using the SELECT item.
 - Correlation between [F1] (for selecting a setting using the SELECT item) and [F3] on the file selection screen**

[F1] Settings selected using SELECT item	[F3] Displays and function
Still1, Still2, Clip1, Clip2	F3: LIST VIEW Using the [F3], it is possible to switch the screen display between "List (list files)" and "Thumbnail" (display thumbnails)*.
Shot, Event, Set Up, All, Upgrade	F3: The [F3] cannot be operated. On the screen, the list of files is displayed.
Plug-in	F3: INDEX Using the [F3], it is possible to select the index number (1 to 10) of the files to be loaded. On the screen, the list of files is displayed.

*: This function can be actuated in any model whose system version is V2.00.00 and up.
The display cannot be switched to "Thumbnail" with a model whose system version is below V2.00.00.

- Use [F2] to select the name of the file to be loaded using the SELECT FILE item.
If the name of the file to be loaded consists of more than 8 characters, a shortened version of the filename will be displayed.
 - When "Plug-in" has been selected using [F1] (SELECT item), use [F3] to select the index number (1 to 10) of the files to be loaded.
 - Up to 100 files can be loaded from one folder.
 - The following alphanumeric characters and symbols can be used as the characters for filenames (see below). Files using other characters will not be displayed by the unit.

<Characters which can be used for filenames>

A to Z, a to z, 0 to 9, Space, ! # \$ % & ' () - . @ ^ _ ` { }

- Use [F4] to load the file.

Changing the sort mode

The way in which the file list displayed on the file selection screen is arranged can be specified.

- On the SD Card menu, use [F1] to display the File2 sub menu.

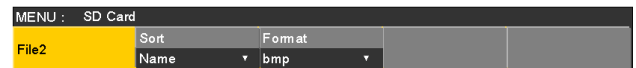

- Use [F2] to select the sort mode for the file selection screen using the Sort item.

Newest	The files are arranged in sequence starting with the file having the most recent registration date and time.
Oldest	The files are arranged in sequence starting with the file having the oldest registration date and time.
Name	The files are arranged in filename sequence.

1. Basic operations

1-12-4. Deleting files on memory cards

- ① Insert the memory card on which the data is stored into the memory card slot.
- ② On the SD Card menu, use [F1] to display the File1 sub menu.



- ③ Use [F2] to select “Delete” using the Mode item, and then press the [F2].
When [F2] is pressed, the file selection screen is displayed.

<Example of what appears on the file selection screen>

TOTAL: 6FILES					
FILE NAME	SIZE	TYPE	FRAME	KEY	DATE
hs001.bmp	1920 * 1080	Still	1		12-02-2009 19:38
hs002.bmp	1920 * 1080	Still	1		12-02-2009 19:38
hs003.png	1920 * 1080	Still	1	●	12-02-2009 19:39
hs004.png	1920 * 1080	Still	1	●	12-02-2009 19:40
hs005.jpg	1920 * 1080	Still	1		12-02-2009 19:40
hs006.jpg	1920 * 1080	Still	1		12-02-2009 19:40

F1:SELECT Still F2:SELECT FILE F3:LIST VIEW List F4:OK(DELETE) F5:CANCEL

- ④ Use [F1] to select the type of file to be deleted using the SELECT item.
If the name of the file to be loaded consists of more than 8 characters, a shortened version of the filename will be displayed.
- ⑤ Use [F2] to select the name of the file to be deleted using the SELECT FILE item.
- ⑥ Use [F4] to delete the file.

1-12-5. Displaying the memory card information

- ① Insert the memory card on which the data is stored into the memory card slot.
- ② On the SD Card menu, use [F1] to display the Card Information sub menu.





Free Space	The memory card's total memory and remaining free space are displayed in megabyte units (MB). (Free space/card's total memory)
-------------------	-----------------------------------------------------------------------------------------------------------------------------------

1. Basic operations

1-13. Waveform monitor settings

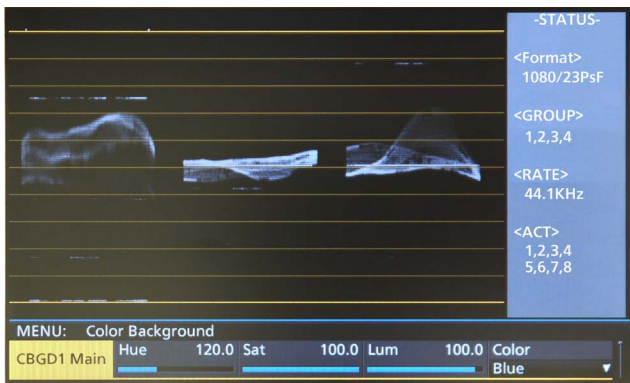
WFM (waveform monitor) settings



- ① Press the [WFM/VECT] button among the display mode buttons to display the waveform monitor on the built-in display.
- ② Press the  button to light its indicator, and display the Config menu.
- ③ Use [F1] to display the WFM sub menu.

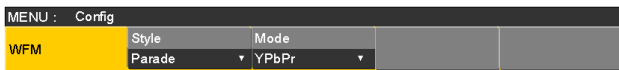

- ④ Use [F2] to select the method to be used to display the signal waveforms using the Style item.

Parade	The signal waveforms are arranged and displayed.
Overlay	The signal waveforms are superimposed onto each other and displayed.

- ⑤ Use [F3] to select the signals whose waveforms are to be displayed using the Mode item.

YPbPr	Waveforms of the Y, Pb and Pr signals are displayed.
RGB	Waveforms of the R, G and B signals are displayed.
Y	Waveforms of the Y signal only are displayed.

VECTOR (vectorscope) settings



- ① Press the [WFM/VECT] button among the display mode buttons to display the vectorscope on the built-in display.
- ② Press the  button to light its indicator, and display the Config menu.
- ③ Use [F1] to display the Vector sub menu.



- ④ Use [F2] to select the color bar reference marker using the Bar Target item.

75%	The 75% color bar reference marker is displayed.
100%	The 100% color bar reference marker is displayed.

1. Basic operations

1-14. Setting the status display

Displaying the audio status

When the menu display mode has been set to “1 line of menu display and full-screen image display”, the audio status of the signals selected by the DISP bus is displayed on the WFM or VECTOR screen.

When SDI input signals are selected:

The status of the embedded audio is displayed.

When PGM, PVW, MV or AUX signals are selected:

When “ON” has been selected as the ancillary data setting, the status of the embedded audio is displayed.

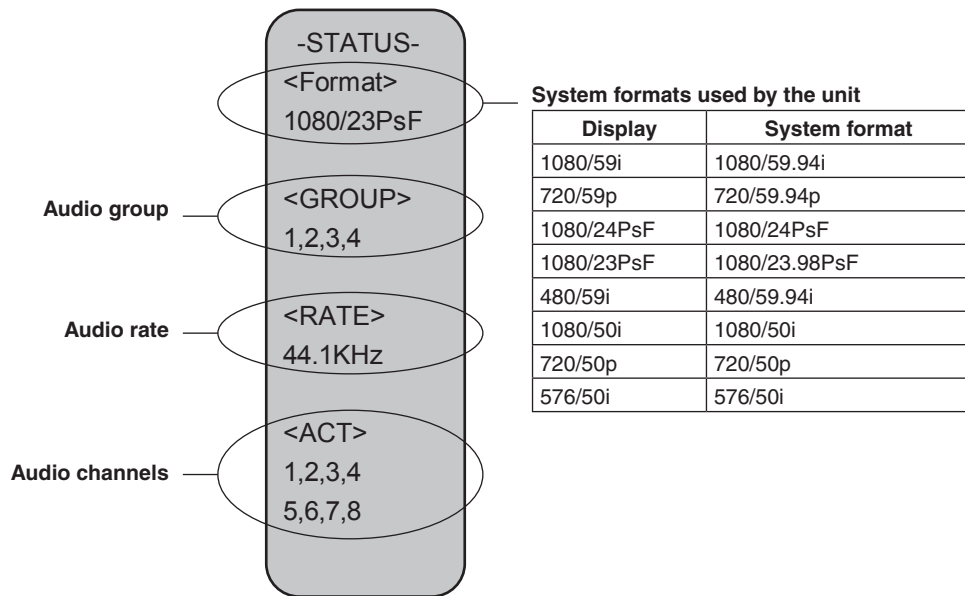

2. Input/output signal settings

2-1. Input signal settings

SDI IN1 to SDI IN8 are SDI signal inputs.

DVI IN is DVI-D signal input.

IN A1, IN A2, IN B1 and IN B2 can be set only when one of the following option boards has been connected.

- AV-HS04M1 (SDI Input Board)
- AV-HS04M2 (Analog Input Board)
- AV-HS04M3 (DVI Input Board)
- AV-HS04M6 (Analog Composite Input Board)
- AV-HS04M8 (Full-HD DVI Input Board)

Before setting the input signals, first select the input signal to be set using the Input sub menu.

① Press the  button to light its indicator, and display the Input menu.

② Use [F1] to display the Input sub menu.



③ Use [F2] to select the input signals using the Select item.

The menu display is switched in accordance with the input signals which have been selected.

The menu title is set to “MENU: Input (signal type)/input connector (material name)”.

Signal type	SDI, Analog, DVI, Composite
Material name	Material name set in “2-1-5. Setting the material names”.

<Example of menu (SDI)>

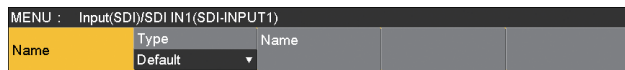

2. Input/output signal settings

<List of settings by input signal>

Input connector		Setting menu and numbers of sections in this manual					
		FS	Mode	Delay	Freeze	Name	Up Converter
		2-1-1	2-1-2	2-1-3	2-1-4	2-1-5	2-1-6
SDI IN1 to SDI IN4	Standard SDI input ×8 lines	✓	Only Dot by Dot selectable	—	✓	✓	—
SDI IN5, SDI IN6		✓	✓	—	✓	✓	✓
SDI IN7, SDI IN8		✓	✓	✓	✓	✓	✓
DVI IN	Standard DVI-D input ×1 line	—	—	—	✓	✓	—
Option slot IN A1, IN A2, IN B1, IN B2	AV-HS04M1 SDI input ×2 lines	✓	✓	—	✓	✓	✓
	AV-HS04M2 Analog component input ×2 lines	✓	✓	—	✓	✓	✓
	AV-HS04M3 DVI-I input ×2 lines	—	—	—	✓	✓	—
	AV-HS04M6 Analog composite input ×2 lines	✓	✓	—	✓	✓	✓
	AV-HS04M8 DVI-D input ×2 lines	—	—	—	✓	✓	—

Input connector		Setting menu and numbers of sections in this manual				
		Video Process (SDI)	Gain	Video Process (Composite)	DVI Input (Digital)	DVI Input (Analog)
		2-1-7	2-1-8	2-1-9	2-1-10	2-1-10
SDI IN1 to SDI IN4	Standard SDI input ×8 lines	✓	—	—	—	—
SDI IN5, SDI IN6		✓	—	—	—	—
SDI IN7, SDI IN8		✓	—	—	—	—
DVI IN	Standard DVI-D input ×1 line	—	—	—	✓	—
Option slot IN A1, IN A2, IN B1, IN B2	AV-HS04M1 SDI input ×2 lines	—	—	—	—	—
	AV-HS04M2 Analog component input ×2 lines	—	✓	—	—	—
	AV-HS04M3 DVI-I input ×2 lines	—	—	—	✓	✓
	AV-HS04M6 Analog composite input ×2 lines	—	✓	✓	—	—
	AV-HS04M8 DVI-D input ×2 lines	—	—	—	✓	—

✓: Can be set.
—: Cannot be set.

2. Input/output signal settings

2-1-1. Setting the frame synchronizer

The frame synchronizer can be set to On or Off for each input.
The DVI input frame synchronizer is permanently On.
It cannot be set from On to Off or vice versa.

- ① On the Input sub menu, use [F2] to select the input to be set using the Select item.

☞ Refer to “2-1. Input signal settings”.

- ② Use [F1] to display the FS sub menu.



- ③ Use [F2] to set On or Off for the frame synchronizer using the FS item.
 - If the output signal phase is set to 0H, Off cannot be selected as the FS item setting.

AVDL function is active while the frame synchronizer function is set to Off.

The AVDL function automatically adjusts the input image signal phase to the horizontal synchronization reference signal phase.

For details, refer to “2-4. Adjusting the output signal phase”.

2. Input/output signal settings

2-1-2. Setting the input mode

The mode can be set for each input only when HD has been selected as the system format.
When SD is selected as the system format, the input mode is always the same as Normal.

① On the FS sub menu, use [F3] to set the input mode using the Mode item.

Normal	Input signals in conformity with the system format take effect.
Dot by Dot	When SD signals with the same frame rate as the system format have been input, they are input on a dot by dot (1× magnification) basis with no up-conversion. (This setting is only possible when the system format is 1080i.) In this mode, there is minimal deterioration in the image quality and, as such, the mode is used to combine SD format material using the PinP function.
Up Convert	When SD signals with the same frame rate as the system format have been input, they are up-converted.
Auto	Input signals in conformity with the system format take effect. Furthermore, if SD signals with the same frame rate as the system format are input when HD is selected as the system format, they are up-converted. ● In the Auto mode, the images may be disturbed when the input signals are switched.

<List of input modes supported>

System	Mode	Input								
		480/ 59.94i	576/ 50i	1080/ 59.94i	1080/ 50i	1080/ 24PsF	1080/ 23.98PsF	720/ 59.94p	720/ 50p	
SD	480/59.94i	—	■	■	■	■	■	■	■	■
	576/50i	—	■	■	■	■	■	■	■	■
HD	1080/59.94i	Normal	■	■	■	■	■	■	■	■
		Dot by Dot	■	■	■	■	■	■	■	■
		Up Convert	■	■	■	■	■	■	■	■
		Auto (Up Convert)	■	■	■	■	■	■	■	■
	1080/50i	Normal	■	■	■	■	■	■	■	■
		Dot by Dot	■	■	■	■	■	■	■	■
		Up Convert	■	■	■	■	■	■	■	■
		Auto (Up Convert)	■	■	■	■	■	■	■	■
	1080/24PsF	Normal	■	■	■	■	■	■	■	■
		Dot by Dot	■	■	■	■	■	■	■	■
		Up Convert	■	■	■	■	■	■	■	■
		Auto	■	■	■	■	■	■	■	■
1080/23.98PsF	Normal	■	■	■	■	■	■	■	■	
	Dot by Dot	■	■	■	■	■	■	■	■	
	Up Convert	■	■	■	■	■	■	■	■	
	Auto	■	■	■	■	■	■	■	■	
720/59.94p	Normal	■	■	■	■	■	■	■	■	
	Up Convert	■	■	■	■	■	■	■	■	
	Auto (Up Convert)	■	■	■	■	■	■	■	■	
720/50p	Normal	■	■	■	■	■	■	■	■	
	Up Convert	■	■	■	■	■	■	■	■	
	Auto (Up Convert)	■	■	■	■	■	■	■	■	

- ■ denotes a black screen.
- The Up Convert mode or Auto mode cannot be selected for inputs 1 to 4.
- If Dot by Dot, Up Convert or Auto mode is selected, the frame synchronizer will be turned on.
- The input mode cannot be changed when freeze is set to on.

2. Input/output signal settings

2-1-3. Setting the delay amount

The input signals can be delayed.

- The delay can be applied only to the SDI IN7 and SDI IN8 input signals.

① On the Input sub menu, use [F2] to select the input to be set using the Select item.

☞ Refer to “2-1. Input signal settings”.

② Use [F1] to display the FS sub menu.



③ Use [F4] to set the delay amount using the Delay item.

2-1-4. Freezing the input signals

The input signals can be frozen and used.

While signals are frozen, the tally signals of the corresponding input will not be output.

Setting freeze

① On the Input sub menu, use [F2] to select the input to be set using the Select item.

☞ Refer to “2-1. Input signal settings”.

② Use [F1] to display the Freeze sub menu.

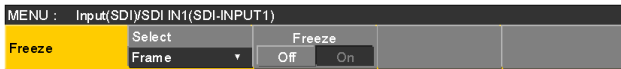

③ Use [F2] to select the freeze method using the Select item.

Frame	The images are frozen frame by frame.
Field	The images are frozen field by field. This is used to freeze moving images. With interlace signals, however, diagonal lines and moving parts appear jagged.

Frame or Field can also be selected while an image is frozen.

④ Press the [F3] to freeze the input image or cancel the freeze.

If the [F3] is pressed while the display is “Off”, the video signal is frozen, and the display is set to “On”.

If the [F3] is pressed while the display is “On”, the video signal freezing is canceled, and the display is set to “Off”.

The “F” mark appears in front of the name of the material when the signals set for output of multi view displays are frozen.

- When the unit is used with the frame synchronizer function OFF, the output images may be disturbed when freezing is executed, but the frozen images will not be adversely affected.
- If, when the switcher is used with the frame synchronizer function at OFF, “On” is set as the freeze setting, the frame synchronizer function will be automatically switched to ON.

2-1-5. Setting the material names

Material names can be given to the input signals.

These names can be selected from the default settings or user settings.

① On the Input sub menu, use [F2] to select the input to be set using the Select item.

☞ Refer to “2-1. Input signal settings”.

② Use [F1] to display the Name sub menu.

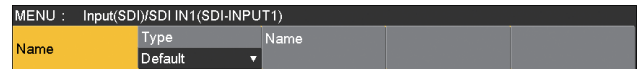

③ Use [F2] to select the type of material names using the Type item.

Default (default settings)	Select the material names from the following: SDI IN1 to SDI IN8, DVI IN, IN-A1, IN-A2, IN-B1 and IN-B2.
User (user settings)	The material names are set using up to 7 characters.

2. Input/output signal settings

2-1-6. Setting the up-converter

Select the settings for SDI IN5 to SDI IN8, as well as for the up-converter that is built into the option boards listed below:

- AV-HS04M1 (SDI Input Board)
- AV-HS04M2 (Analog Input Board)
- AV-HS04M6 (Analog Composite Input Board)

① On the Input sub menu, use [F2] to select the input to be set using the Select item.
 Refer to “2-1. Input signal settings”.

② Use [F1] to display the Up Converter1 sub menu.



③ Use [F2] to select the scaling system using the Scale item.

Squeeze	The image is enlarged both horizontally and vertically to fill the entire screen.
Edge Crop	The aspect ratio of the image is maintained, the image size is increased in accordance with the vertical resolution, and black bands are added at the left and right.
Letter Box	The aspect ratio of the image is maintained, the image size is increased in accordance with the horizontal resolution, and the image is cropped at the top and bottom.

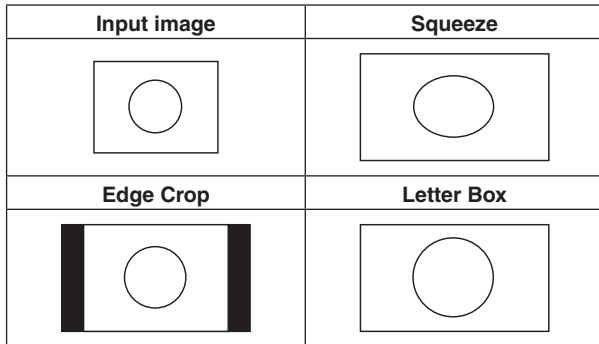

④ Use [F3] to set the image movement detection sensitivity using the Move Detect item.

1	Toward still images
↑ ↓	
3	Standard
↑ ↓	
5	Toward moving images

⑤ Use [F4] to set the extent of the edge sharpness for the images using the Sharp item.

1	Not sharp edges
↑ ↓	
3	Standard
↑ ↓	
5	Very sharp edges

⑥ Use [F5] to adjust the input image size (100 % to 110 %).

Fine-tuning of image positions

Fine-tuning of image positions is performed when “Edge Crop” is selected for the scaling method.

① Use [F1] to display the Up Converter2 sub menu.



② Use [F2] to select the image position using the Edge Crop Pos item.

Center	The image is positioned at the center, and black images are added at the left and right.
Right	The image is positioned at the right, and a black image is added at the left.
Left	The image is positioned at the left, and a black image is added at the right.

Setting the gamut limiter

① On the Up Converter2 sub menu, use [F4] to set the color range of the input signals using the Limiter item.



Off	The color range is not restricted.
108	The amplitude level of the colors (R, G and B) is restricted to 0 % - 108 %.
104	The amplitude level of the colors (R, G and B) is restricted to 0 % - 104 %.
100	The amplitude level of the colors (R, G and B) is restricted to 0 % - 100 %.

2. Input/output signal settings

2-1-7. Setting the video process function

The video process function works for all the SDI input signal images.

The color tones can be changed for each input.

- ① On the Input sub menu, use [F2] to select the input to be set using the Select item.

☞ Refer to “2-1. Input signal settings”.

- ② Use [F1] to display the Video Process1 sub menu.

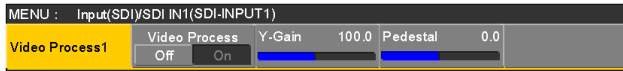

- ③ Use [F2] to select enable (On) or disable (Off) for the video process function using the Video Process item.
- ④ Use [F3] to set the Y signal gain using the Y-Gain item.
- ⑤ Use [F4] to set the pedestal level using the Pedestal item.
- ⑥ Use [F1] to display the Video Process2 sub menu.

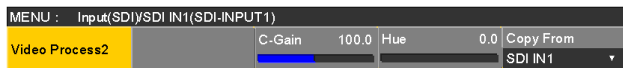

- ⑦ Use [F3] to set the saturation gain using the C-Gain item.
- ⑧ Use [F4] to set the change in the hue using the Hue item.

Copying the settings

The video process settings already selected can be set for other input signals as well.

On the Video Process2 sub menu, use [F5] to select the input signals of the copy destination, and press [F5].



2-1-8. Setting the analog input gain (option)

When the analog input board (option) has been connected, the gain of the input signals can be set.

Alternatively, when the analog composite input board (option) has been connected, the gain of the Y signals can be set.

The setting range is ± 30 steps, and the gain changes by approximately ± 2 dB. The amount of change in the gain when it is changed by one step is not fixed.

- ① On the Input sub menu, use [F2] to select the input to be set using the Select item.

☞ Refer to “2-1. Input signal settings”.

- ② Use [F1] to display the Video Process sub menu.



- ③ Use [F2] to set the gain of the input signal (Y signal gain) using the Gain item.

2. Input/output signal settings

2-1-9. Setting the analog composite input signals (option)

When the analog composite input board (option) has been connected, the analog composite input signals can be set.

- ① On the Input sub menu, use [F2] to select the input to be set using the Select item.

☞ Refer to “2-1. Input signal settings”.

- ② Use [F1] to display the Video Process sub menu.

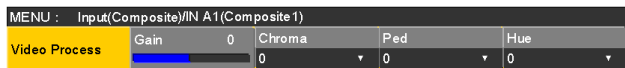

- ③ Use [F2] to set the gain of the input signal (Y signal gain) using the Gain item.
- ④ Use [F3] to adjust the chroma level using the Chroma item.
(Maximum amount of variation: approx. ± 3 dB)
The auto color control function is activated, and the chroma level is kept at the value that has been set.
- ⑤ Use [F4] to adjust the pedestal level using the Ped item.
(Maximum amount of variation: approx. ± 100 mV)
- ⑥ Use [F5] to adjust the hue using the Hue item.
(Maximum amount of variation: approx. $\pm 20^\circ$)
Adjustment of Hue is possible when the system format is 1080/59.94i, 720/59.94p and 480/59.94i.

For details on the other settings, refer to the operating instructions of the option board.

2. Input/output signal settings

2-1-10. Setting the DVI input signals

Set the DVI input signals when the DVI input board (option) or full-HD DVI input board (option) has been connected. Signals with the following resolutions can be input.

DVI input signals	Standard (Digital)	DVI Input Board (Digital/Analog)	Full-HD DVI Input Board (Digital)
XGA (1024 × 768)/60 Hz	✓	✓	✓
WXGA (1280 × 768)/60 Hz	✓	✓	✓
SXGA (1280 × 1024)/60 Hz	✓	✓	✓
WSXGA+ (1680 × 1050)/60 Hz	✓	—	✓
UXGA (1600 × 1200)/60 Hz	✓	—	✓
WUXGA (1920 × 1200)/60 Hz	✓	—	✓
1080/59.94p (1920 × 1080)/59.94 Hz	✓	—	✓
1080/50p (1920 × 1080)/50 Hz	✓	—	✓
1080/59.94i (1920 × 1080)/59.94 Hz	✓	—	—
1080/50i (1920 × 1080)/50 Hz	✓	—	—
720/59.94p (1280 × 720)/59.94 Hz	✓	—	—
720/50p (1280 × 720)/50 Hz	✓	—	—

✓: Can be set.
—: Cannot be set.

- If signals with any other resolutions or frequencies are input, the signals cannot be imported correctly. The images which are output at a time like this may be black or disturbed.
- These boards are incompatible with the HDCP (High-bandwidth Digital Content Protection).

① On the Input sub menu, use [F2] to select the input to be set using the Select item.
☞ Refer to “2-1. Input signal settings”.

② Use [F1] to display the DVI Input sub menu.



③ Use [F2] to select the signal system using the Mode item.

- Set this when the DVI input board (AV-HS04M3) has been connected.

Digital	Digital input signals of the DVI connector are effective.
Analog	Analog input signals of the DVI connector are effective.











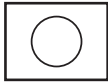
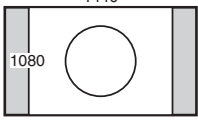
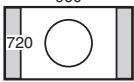

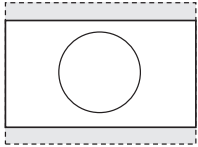
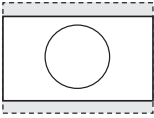
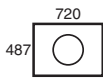
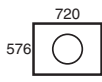
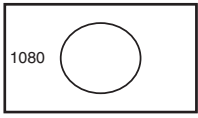
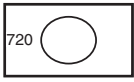

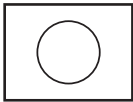
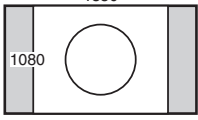
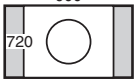

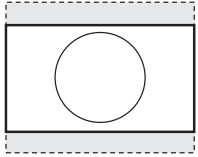
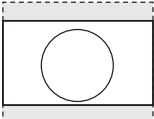
④ Use [F3] to select the scaling method.

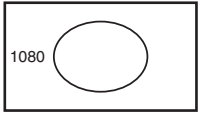
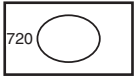
Fit-V	The aspect ratio of the input images is maintained, and the size of the images is increased or reduced in accordance with the vertical resolution.
Fit-H	The aspect ratio of the input images is maintained, and the size of the images is increased or reduced in accordance with the horizontal resolution.
Full	The size of the input images is increased or reduced in accordance with the system resolution. (The aspect ratio of the input images is not kept the same. The rate at which the image size is increased or reduced in the vertical direction and in the horizontal direction differs.)

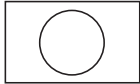
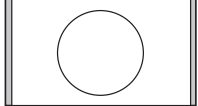
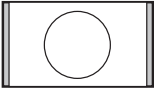
For details on the sizes that correspond to the formats, refer to “DVI input scaling size table” (on page 83).

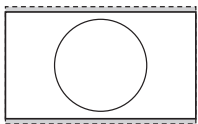
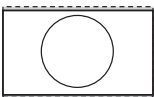
2. Input/output signal settings

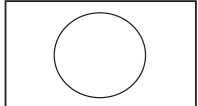
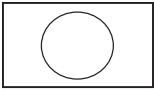







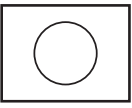
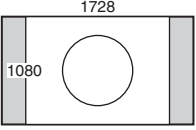
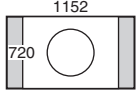

■ DVI input scaling size table

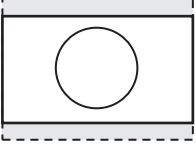
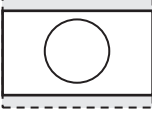
DVI format	Mode	HD/1080i	HD/720P	SD/NTSC	SD/PAL
		1920 × 1080	1280 × 720	720 × 487	720 × 576
XGA 1024 × 768 	Fit-V	1440 	960 	720 	720 
	Fit-H			720 	720 
	Full	1920 	1280 	720 	720 
SXGA 1280 × 1024 	Fit-V	1350 	900 	675 	675 
	Fit-H				
	Full	1920 	1280 	720 	720 
WXGA 1280 × 768 	Fit-V				
	Fit-H				
	Full				

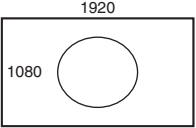
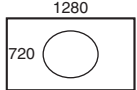
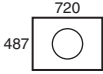
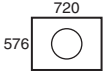
■: Black images are inserted here.

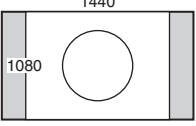
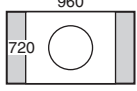
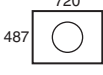
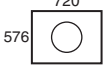
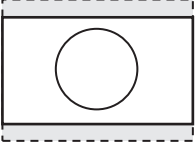
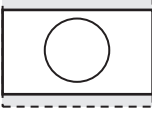
■: The parts of the images protruding in these areas are cropped.

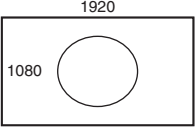
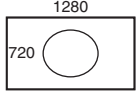
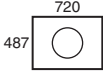
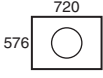
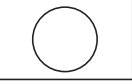
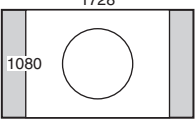
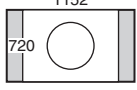
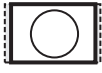
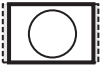
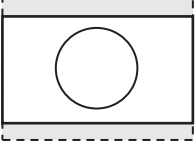
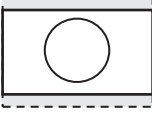

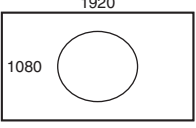
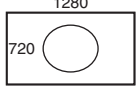
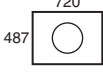
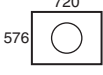







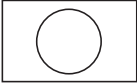
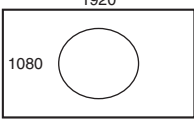
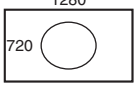

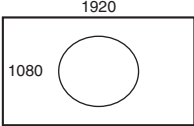
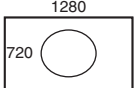

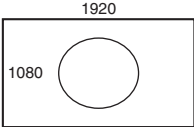
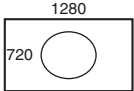
2. Input/output signal settings

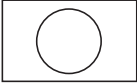
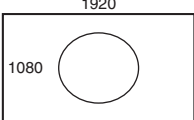
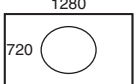
DVI format	Mode	HD/1080i	HD/720P	SD/NTSC	SD/PAL
		1920 × 1080	1280 × 720	720 × 487	720 × 576
WSXGA+ 1680 × 1050 	Fit-V				
	Fit-H				
	Full				
UXGA 1600 × 1200 	Fit-V				
	Fit-H				
	Full				
WUXGA 1920 × 1200 	Fit-V				
	Fit-H				
	Full				

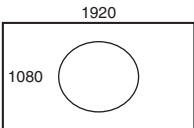
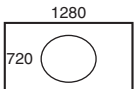
■: Black images are inserted here.

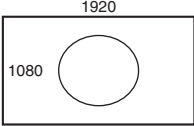
■: The parts of the images protruding in these areas are cropped.

2. Input/output signal settings

DVI format	Mode	HD/1080i	HD/720P	SD/NTSC	SD/PAL
		1920 × 1080	1280 × 720	720 × 487	720 × 576
1080/59.94p 1080/50p 1080/59.94i 1080/50i 1920 × 1080 	Fit-V				
	Fit-H				
	Full				
720/59.94p 720/50p 1280 × 720 	Fit-V				
	Fit-H				
	Full				

: Black images are inserted here.

: The parts of the images protruding in these areas are cropped.

2. Input/output signal settings

2-1-11. Displaying the DVI input signal information

These are used to display the information concerning the DVI-D input signal images.
The information cannot be changed.

- ① On the Input sub menu, use [F2] to select the input to be set using the Select item.
☞ Refer to “2-1. Input signal settings”.
- ② Use [F1] to display the DVI Status sub menu.

MENU : Input(DVI)DVI IN(DVI-INPUT1)				
DVI Status	Size ***x***	Dot Clock ***.MHz	H-Frequency **.*kHz	V-Frequency **.*Hz

Size	This indicates the pixel count of the images.
Dot Clock	This indicates the dot clock frequency of the images.
H-Frequency	This indicates the horizontal frequency of the images.
V-Frequency	This indicates the vertical frequency of the images.

The formats supported are listed below.

<DVI-D formats supported>

Input video signal			Dot clock frequency (MHz)	Frequency	
				Horizontal (kHz)	Vertical (Hz)
XGA	1024 × 768	Digital	65.0	48.36	60.00
WXGA	1280 × 768	Digital	79.5	47.78	59.87
SXGA	1280 × 1024	Digital	108.0	63.98	60.02
WSXGA+	1680 × 1050	Digital	146.2	65.29	59.95
UXGA	1600 × 1200	Digital	162.0	75.00	60.00
WUXGA	1920 × 1200	Digital	154.0	74.04	59.95
1080/50p	1920 × 1080	Digital (RGB)	148.5	56.25	50.00
1080/59.94p	1920 × 1080	Digital (RGB)	148.5/1.001	67.50/1.001	60.00/1.001
1080/50i	1920 × 1080	Digital (RGB)	74.25	28.13	50.00
1080/59.94i	1920 × 1080	Digital (RGB)	74.25/1.001	33.72	60.00/1.001
720/50p	1280 × 720	Digital (RGB)	74.25	37.50	50.00
720/59.94p	1280 × 720	Digital (RGB)	74.25/1.001	44.96	60.00/1.001

- If the format of the input signals is not supported, it may not be possible to import the signals properly, and a black image or disturbed image may appear.

2. Input/output signal settings

2-1-12. Adjusting the DVI input signals

These are used to adjust the clock/phase and position of the DVI-D input signal.

Select the clock/phase and position of the signals when the DVI input board (AV-HS04M3) has been connected.

- ① On the Input sub menu, use [F2] to select the input to be set using the Select item.
☞ Refer to “2-1. Input signal settings”.

- ② Use [F1] to display the DVI Phase sub menu.

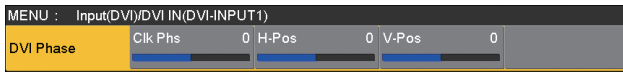

- ③ Use [F2] to adjust the clock phase of the analog input signals using the Clk Phs item.
While viewing the image quality, set the value at which the noise level is minimized.
- ④ Use [F3] to adjust the horizontal position using the H-Pos item.
- ⑤ Use [F4] to adjust the vertical position using the V-Pos item.

2-1-13. Automatic adjustment of the black level and white level (analog input signals)

The black level (offset) and white level (gain) of the analog input signals are adjusted automatically.

- Set this when the DVI input board (AV-HS04M3) has been connected.

Depending on the computer used, there may be some deviation from the correct levels of the black level or white level.

To proceed with automatic adjustment to correct this deviation, display the black-and-white signals (BW.bmp) on the supplied CD-ROM or the full-screen black signals and full-screen white signals on the computer connected to the DVI input connector, and input these signals as the DVI input signals.

When using the black-and-white signals, position them so that the boundary between black and white comes to the center of the monitor screen.

When using the full-screen black signals or full-screen white signals, display the black or white in an area that covers at least 80 % of the screen from the screen center.

Before making any adjustments, follow the instructions given in the “Automatic adjustment of the black level” section.

Automatic adjustment of the black level

Input the black-and-white signals (BW.bmp) or full-screen black signals.

Use [F5] to select “Black” in the Auto item, and press [F5] to adjust the black level automatically.

“Auto Setting” is displayed on the built-in display while adjustments are being made.

Automatic adjustment of the white level

Input the black-and-white signals (BW.bmp) or full-screen white signals.

Use [F5] to select “White” in the Auto item, and press [F5] to adjust the white level automatically.

“Auto Setting” is displayed on the built-in display while adjustments are being made.

Initializing the adjusted values

Use [F5] to select “Init” in the Auto item, and press [F5] to return the adjusted values to their factory settings.

“Auto Setting” is displayed on the built-in display while adjustments are being made.

2. Input/output signal settings

2-2. Output signal settings

SDI OUT1 to SDI OUT5 are SDI signal outputs.

DVI OUT is DVI-D signal output.

OUT A1, OUT A2, OUT B1 and OUT B2 can be set only when one of the following option boards has been connected.

- AV-HS04M4 (Analog Output Board)
- AV-HS04M5 (DVI/Analog Output Board)
- AV-HS04M7 (SDI Output Board)

Before proceeding to set the output signals, first select the output signals to be set using the Output sub menu.

① Press the  button to light its indicator, and display the Output menu.

② Use [F1] to display the Output sub menu.



③ Use [F2] to select the output signals using the Select item.

The menu display is switched depending on the selected output signals.

The menu title is set to "MENU: Output (signal type)/output connector".

Signal type	SDI, Analog, DVI-D, DVI-I
--------------------	---------------------------

<Example of menu (SDI)>

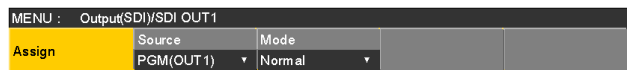

<List of settings by output signal>

Output connector		Setting menu and numbers of sections in this manual				
		Assign	SDI Output	DVI Output (Digital)	DVI Output (Analog)	Down Converter
		2-2-1	2-2-2	2-2-3	2-2-3	2-2-4
SDI OUT1 to SDI OUT5	Standard SDI output ×5 lines	✓	✓	—	—	—
DVI OUT	Standard DVI-D output ×1 line	✓	—	✓	—	—
Option slot OUT A1, OUT A2,	AV-HS04M4 Analog component output ×2 lines	✓	—	—	—	—
	AV-HS04M5 DVI-I output ×1 line Analog component output ×1 line	✓	—	—	✓	—
	AV-HS04M7 SDI output ×2 lines	✓	✓	—	—	✓
Option slot OUT B1, OUT B2	AV-HS04M4 Analog component output ×2 lines	✓	—	—	—	—
	AV-HS04M5 DVI-I output ×1 line Analog component output ×1 line	✓	—	—	✓	—
	AV-HS04M7 SDI output ×2 lines	✓	✓	—	—	✓

✓: Can be set.
—: Cannot be set.

2. Input/output signal settings

2-2-1. Assigning the output signals

The output signals can be assigned to the SDI OUT1 to SDI OUT5 connectors and DVI OUT connector.

- On the Output sub menu, use [F2] to select the output to be set using the Select item.
Refer to “2-2. Output signal settings”.

- Use [F1] to display the Assign sub menu.

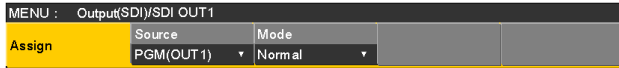

- Use [F2] to set the type of output signal using the Source item.

PGM	An image provided with the wipe, mix, key, downstream key or other effect is output at the switcher's main line output.
PVW	This is the preview output that enables the next operation to be checked before it is executed.
AUX1 to 4	The signals selected by the 4 lines of AUX buses (AUX1 to AUX4) are output.
CLN	The clean signal (the image resulting when the key, downstream key or other effect has been removed from the PGM signal) is output. Refer to “Assigning the CLN signal”.
MV	The multi view display signals are output. Multiple input signals and output signals are reduced in size and output to one screen.
KeyOut	The key signal is output.
MEM-PVW	In the memory preview mode, the shot memory and event memory effects are output to preview.

- Use [F3] to set the output mode using the Mode item.

Normal	The same signals as the system format signals are output.
Down Convert (down-converter)	This can be selected when the SDI output board (option: AV-HS04M7) has been connected. When the system format is 1080/59.94i or 720/59.94p, the signals are output in the 480/59.94i format. When the system format is 1080/50i or 720/50p, the signals are output in the 576/50i format. When the system format is SD (480/59.94i or 576/50i), this setting cannot be selected.

Assigning the CLN signal

Set KEYCLN or DSKCLN as the CLN output.

- Press the button to light its indicator, and display the Config menu.

- Use [F1] to display the Assign sub menu.



- Use [F3] to select the type of output signal using the CLN item.

Key	The PGM signals minus the key effects are output. The Key, PinP1, PinP2 and DSK effects are not added.
DSK	The PGM signal minus the downstream key effects are output.

2-2-2. Setting the SDI output color range

The color range can be set for the SDI output signal images.

- The same setting applies to all the SDI output signals.

- On the Output sub menu, use [F5] to set the color range using the SDI Limit item.
Refer to “2-2. Output signal settings”.



Off	The color range is not restricted.
108	The amplitude level of the colors (R, G and B) is restricted to 0 % - 108 %.
104	The amplitude level of the colors (R, G and B) is restricted to 0 % - 104 %.
100	The amplitude level of the colors (R, G and B) is restricted to 0 % - 100 %.

2. Input/output signal settings

2-2-3. Setting the DVI output signals

Set the DVI output signals of the standard output (DVI OUT) and the DVI output signals if the DVI/analog output board (option) has been connected.

- ① On the Output sub menu, use [F2] to select the output to be set using the Select item.
 ☞ Refer to “2-2. Output signal settings”.
- ② Use [F1] to display the DVI Output sub menu.

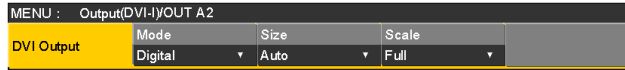

- ③ Use [F2] to select the signal system using the Mode item.
 - Set this when the DVI/analog output board (AV-HS04M5) has been connected.

Digital	DVI digital signals are output from the DVI connector.
Analog	DVI analog signals (RGB) are output from the DVI connector. When “Analog” has been selected, the display position of the image may be off depending on the monitor which is connected. If it is off, adjust the position at the monitor. For details on the adjustment method, refer to the operating instructions of the monitor.

- ④ Use [F3] to select the resolution of the images to be output using the Size item.

Auto	The equipment information of the output destination is captured by the DVI signals, and the images are output at the optimum resolution. The vertical frequency is 60 Hz, and the maximum resolution is SXGA for analog output signals and WUXGA for digital output signals. If the equipment information cannot be captured or if the resolution and frequency which can be output by the unit are not contained in the equipment information, the images will be output at the XGA setting.
-------------	-----------------------------------------------------------------------------------------------------------------------------------------------------------------------------------------------------------------------------------------------------------------------------------------------------------------------------------------------------------------------------------------------------------------------------------------------------------------------------------------------------

Other signals are listed in the table below.

<Table of DVI output signal settings>

DVI output signal		Standard output (DVI OUT)	DVI/Analog Output Board	
Size	Output	(Digital)	(Digital)	(Analog)
XGA	(1024 × 768)/60 Hz	✓	✓	✓
WXGA	(1280 × 768)/60 Hz	✓	✓	✓
SXGA	(1280 × 1024)/60 Hz	✓	✓	✓
WSXGA+	(1680 × 1050)/60 Hz	✓	✓	—
UXGA	(1600 × 1200)/60 Hz	✓	✓	—
WUXGA	(1920 × 1200)/60 Hz	✓	✓	—
1080/59.94p	(1920 × 1080)/59.94 Hz	✓	✓	—
1080/50p	(1920 × 1080)/50 Hz	✓	✓	—
1080/59.94i	(1920 × 1080)/59.94 Hz	✓	—	—
1080/50i	(1920 × 1080)/50 Hz	✓	—	—
720/59.94p	(1280 × 720)/59.94 Hz	✓	—	—
720/50p	(1280 × 720)/50 Hz	✓	—	—

✓: Can be set.
—: Cannot be set.

- The DVI signals cannot be output if the system format is 1080/23.98PsF or 1080/24PsF.

2. Input/output signal settings

- ⑤ Use [F4] to select the scaling method using the Scale item.

Fit-V	The aspect ratio of the output images is maintained, and the size of the images is increased or reduced in accordance with the vertical resolution. (Black bands are inserted into the areas where there are no images. The protruding parts of the images are cropped.)
Fit-H	The aspect ratio of the output images is maintained, and the size of the images is increased or reduced in accordance with the horizontal resolution. (Black bands are inserted into the areas where there are no images. The protruding parts of the images are cropped.)
Full	The size of the output images is increased or reduced in accordance with the system resolution.
Fullx80%	The size of the output image is increased or reduced in accordance with the 80 % size of the system resolution.
Fullx90%	The size of the output image is increased or reduced in accordance with the 90 % size of the system resolution.

- The aspect ratio is not maintained at the Full, Fullx80% or Fullx90% setting.
The rate at which the image size is increased or reduced in the vertical direction and in the horizontal direction differs.

■ Setting the video movement detection sensitivity

- ① Use [F1] to display the Assign sub menu.

MENU : Output(DVI-I)OUT A2		
Assign	Source AUX1	Move Detect 3

- ② Use [F3] to set the image movement detection sensitivity using the Move Detect item.

1	Toward still images
⇕	⇕
3	Standard
⇕	⇕
5	Toward moving images

2. Input/output signal settings

2-2-4. Setting the down-converter (option)

Select the settings for the down-converter that is built into the SDI output board (option: AV-HS04M7).

- On the Output sub menu, use [F2] to select the output to be set using the Select item.
Refer to “2-2. Output signal settings”.

- Use [F1] to display the Down Converter sub menu.

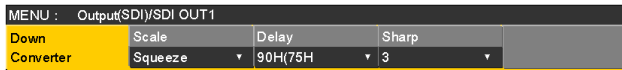

- Use [F2] to select the scaling system using the Scale item.

Squeeze	The top, bottom, left and right are reduced so that the aspect ratio is set to 4:3.
Edge Crop	The aspect ratio is maintained, the image is reduced in size in line with the vertical resolution, and it is cropped at the left and right.
Letter Box	The aspect ratio is maintained, the image is reduced in size in line with the horizontal resolution, and a black image is added at the top and bottom.

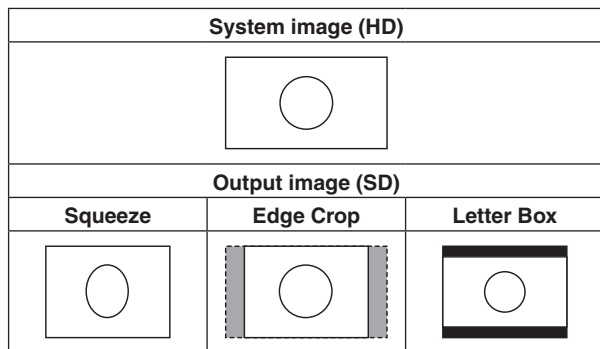

- Use [F3] to set the delay time of the output using the Delay item.

90H(75H)	When the system format is 1080/59.94i, the image is delayed from the system image (HD) by 90H, and output. When the system format is 720/59.94p, the image is delayed from the system image (HD) by 90H+1F (frame), and output. When the system format is 1080/50i, the image is delayed from the system image (HD) by 75H, and output. When the system format is 720/50p, the image is delayed from the system image (HD) by 75H+1F (frame), and output. When the system format is 1080/50i or 720/50p, “75H” is displayed on the menu.
1F	The image is output in-phase with a delay of 1 frame from the system image (HD).

For details on the phase and delay amounts, refer to “2-4. Adjusting the output signal phase”.

- Use [F4] to set the extent of the edge sharpness for the images using the Sharp item.

1	Standard
↑	↓
5	Very sharp edges

For details on the other settings, refer to the operating instructions of the option board.

2. Input/output signal settings

2-3. Setting the sync signals

The sync signals to be used by the system can be selected.

External sync:

For synchronization with an external sync signal (gen-lock).

The reference input signal is looped through and output.

BB	Black burst signal (vertical phase of 0H)
BB Advanced	Black burst signal Vertical phase of 90H when the 59.94i or 59.94p format is selected; vertical phase of 75H when the 50i or 50p format is selected
Tri-level sync	Tri-level sync signal (vertical phase of 0H) • This can be selected when the system format is 1080/24PsF.
Internal	For synchronization with an internal reference signal (INT). The REFOUT signal (black burst signal) is output from the two reference connectors. • This cannot be selected when the system format is 1080/24PsF.

- When 1080/24PsF is selected as the format, INT (internal synchronization) cannot be selected in the Sync item of the Reference sub menu.
- This unit supports synchronization signals for field frequencies that are same as those of the system format.

When the unit is set to the 1080/23.98PsF format, however, the unit also supports black burst signals with 10F-1D (compliant with the SMPTE318M standard).

① Press the  button to light its indicator, and display the System menu.

② Use [F1] to display the Reference sub menu.

MENU : System/Unlocked			
Reference	Sync	BB Setup	Gen Lock
	BB	7.5IRE	UnLock

③ Use [F2], select the sync signal using the Sync item, and press the [F2] to enter the selection.

④ Use [F3] to select the setup level of the black burst signal in the internal synchronization mode using the BB Setup item.

This setting takes effect when the video system is 59.94i or 59.94p.

The setup level is fixed at 0 IRE when the system is 50i or 50p.

⑤ The genlock status is displayed in the Gen Lock item.

Locked	Synchronized with the external sync signal or internal reference signal.
UnLock	Not synchronized with the external sync signal or internal reference signal.

2-4. Adjusting the output signal phase

The phase of the output video signals can be adjusted.

① Press the  button to light its indicator, and display the System menu.

② Use [F1] to display the Output Phase sub menu.

MENU : System/Unlocked			
Output Phase	System	H-Phase	V-Phase
	0H	0	0

③ Use [F2], and select "0H" or "1H" using the System item.

0H	The output video signals are output to the system Reference signal with using in-phase. The frame synchronizer function is ON for all input signals.
1H	The output video signals are output to the system Reference signal with 1H delay. When the frame synchronizer function is ON, the output video signals are output with 1 frame + 1H delay.

④ Use [F3] to adjust H phase using the H-Phase item. H-Phase can be adjusted within a range of $-0.5H$ to $+0.5H$.

- The setting displayed on the menu differs depending on the system format.

⑤ Use [F4] to adjust V phase using the V-Phase item. V-Phase can be adjusted within a range of $-100H$ to $+100H$.

2. Input/output signal settings

<Phase adjustment setup>

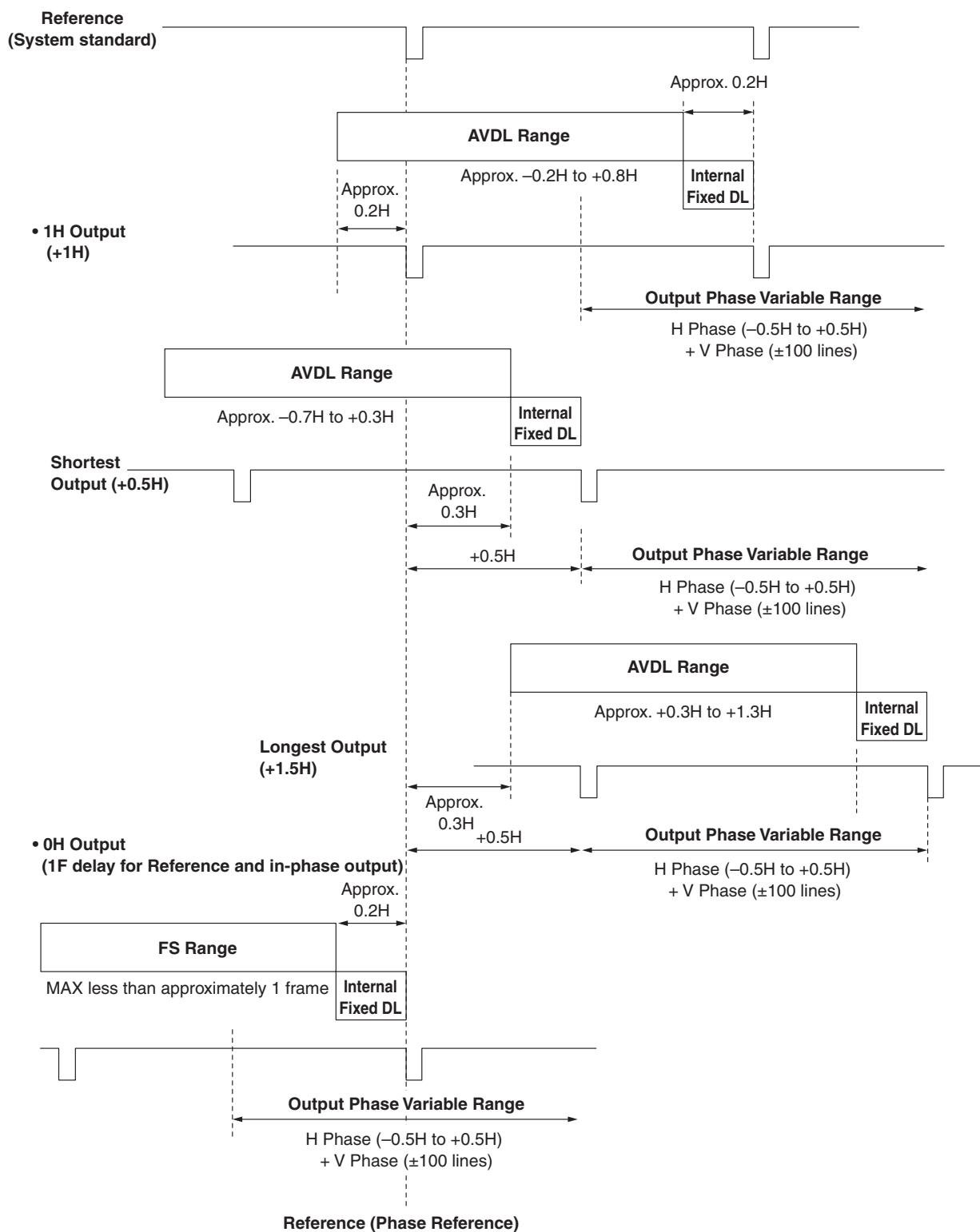

AVDL Range: Range for automatic phase adjustment.

2. Input/output signal settings

<Phases and delay amounts of input/output signals during HD format use>

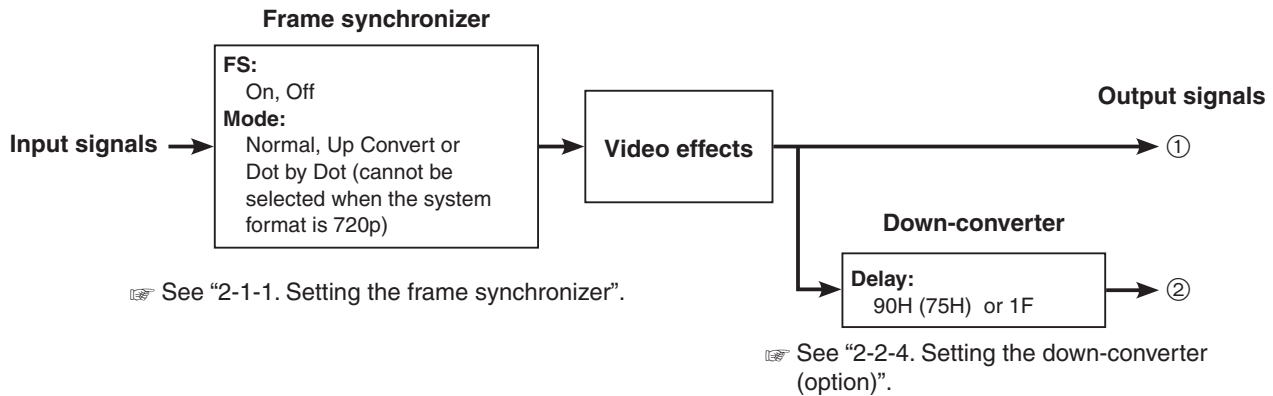

Output Phase	Input		Non-synchronized input	Output signal ① Normal		Output signal ② Down Converter (90H)		Output signal ② Down Converter (1F)	
	System	Mode		FS	Phase	Delay amount	Phase	Delay amount	Phase
Sync signal (Reference): Black burst signal (BB), tri-level sync signal (Tri-level sync), internal reference signal (Internal)									
1H	Normal	Off	Not possible	Reference+1H	1H	①+90H	1H+90H	In-phase with ①	1H+1F
	Normal	On	Possible	Reference+1H	Max. 1F+1H	①+90H	Max. 1F+1H+90H	In-phase with ①	Max. 2F+1H
	Up Convert/Dot by Dot	On (Forced)	Possible						
0H (Example 1)	Normal/Up Convert/Dot by Dot	On (Forced)	Possible	In-phase with Reference	Max. 1F	①+90H	Max. 1F+90H	In-phase with ①	Max. 2F
Sync signal (Reference): Black burst signal (BB Advanced)									
1H	Normal	Off	Not possible	Reference -90H+1H	1H	①+90H	1H+90H	In-phase with ①	1F+1H
	Normal	On	Possible	Reference -90H+1H	Max. 1F-90H+1H	①+90H	Max. 1F+1H	In-phase with ①	Max. 2F-90H+1H
	Up Convert/Dot by Dot	On (Forced)	Possible						
0H (Example 2)	Normal/Up Convert/Dot by Dot	On (Forced)	Possible	Reference -90H	Max. 1F-90H	①+90H (In-phase with Reference)	Max. 1F	In-phase with ①	Max. 2F-90H

- For 1080/50i and 720/50p, the 90H indicated above becomes 75H.
- Conversion based on the HD format applies for 1H.
- When DVE effect and PinP effect have been used as the video effects, the output signal is delayed by +1F.
- The phase and delay amount for the DVI input signals are the same as when Up Convert/Dot by Dot is selected since the frame synchronizer is set to the On mode.
- The DVI output signals are delayed by +1F.
- When images are output to a multi view display, they are delayed by +1F.
- When DVI output signals are output images for a multi view display, the output images are delayed by +2F.

2. Input/output signal settings

<Phase relationship between input signals and output signals>
(for 1080/59.94i format)

(Example 1)

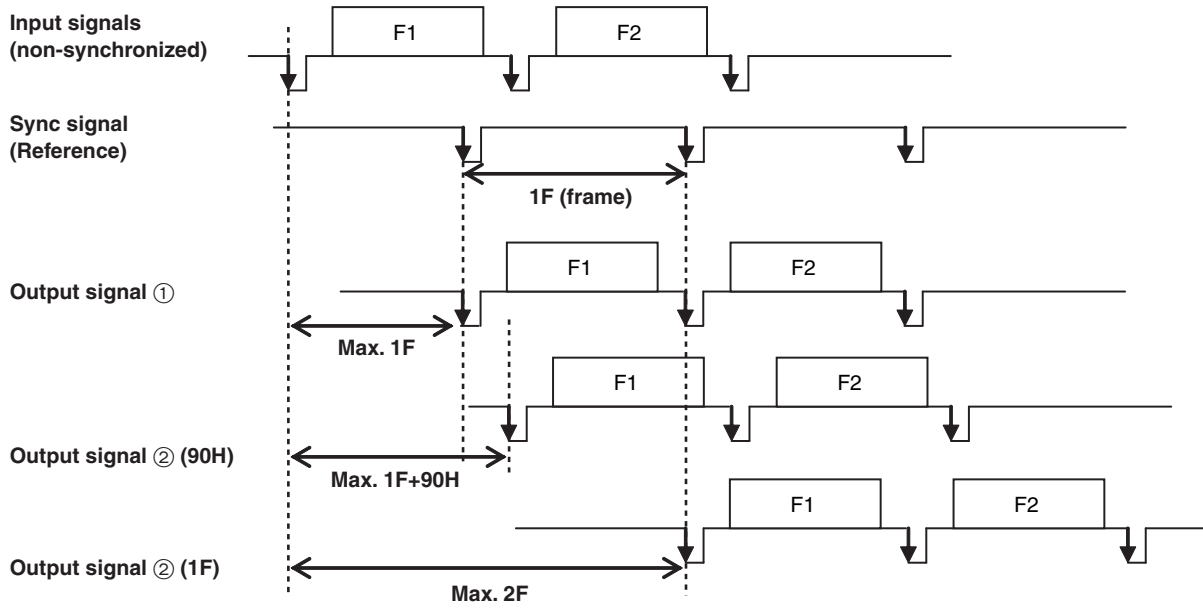

(Example 2)

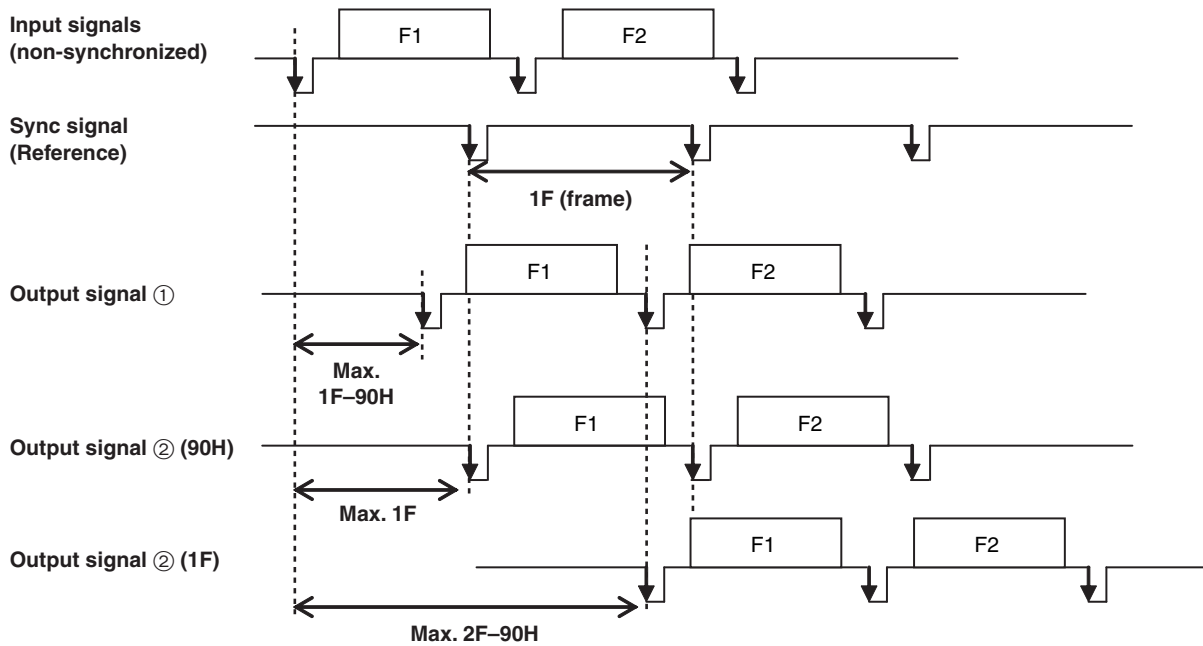

2. Input/output signal settings

2-5. Setting the multi view display

2-5-1. Setting the screen layout

The following nine options are available as split screen layouts.

4Split	5-aSplit	5-bSplit
6-aSplit	6-bSplit	9Split
10-aSplit	10-bSplit	16Split

Display of the following signals can be assigned to sub screens 1 to 16.

Signals that can be assigned
 SDI IN1 to SDI IN8, DVI IN, IN-A1, IN-A2, IN-B1, IN-B2, CBGD1, CBGD2, Still1V, Still1K, Still2V, Still2K, Clip1V, Clip1K, Clip2V, Clip2K, PGM, PVW, MEM-PVW, Key Out, AUX1 to AUX4, Clock

<Display modes>

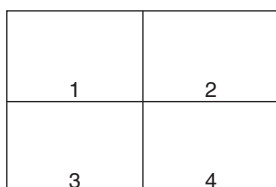

4Split

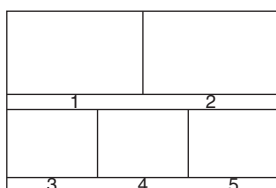

5-aSplit

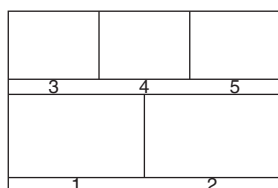

5-bSplit

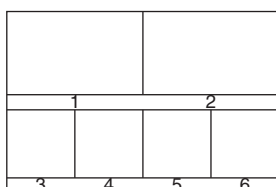

6-aSplit

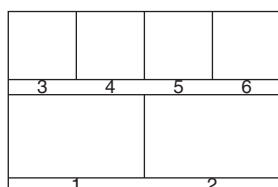

6-bSplit

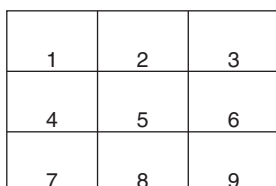

9Split

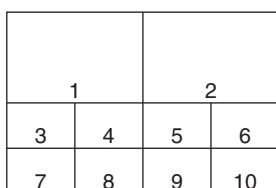

10-aSplit

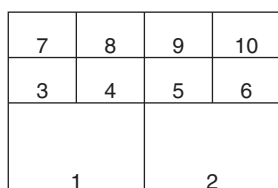

10-bSplit

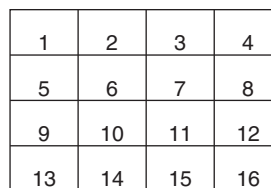

16Split

① Press the button to light its indicator, and display the Multi View Display menu.

② Use [F1] to display the MV Split sub menu.



③ Use [F2] to set the split-screen display mode using the Split item.

④ Use [F1] to display the MV Pattern 1/4 to MV Pattern 4/4 sub menus.



⑤ Use [F2] to [F5] to set the names of the signals to be displayed on the sub screens (1 to 16).

SDI IN1 to SDI IN8, DVI IN, IN-A1, IN-A2, IN-B1, IN-B2, CBGD1, CBGD2, Still1V, Still1K, Still2V, Still2K, Clip1V, Clip1K, Clip2V, Clip2K, PGM, PVW, MEM-PVW, Key Out, AUX1 to AUX4, Clock

- When the input signals (SDI IN1 to SDI IN8, DVI IN, IN-A1, IN-A2, IN-B1 or IN-B2) have been selected, the material name set using the Input menu → Name sub menu is displayed (with up to 10 characters).
- When the input signals have been selected by the AUX buses (AUX1 to AUX4), the first four characters of the material name is displayed inside [].

Display that appears when IN1 (CAM1) has been selected by the AUX1:
 AUX1[CAM1]
Display that appears when IN2 (CAMERA2) has been selected by the AUX2:
 AUX2[CAME]

- When the AUX bus for which “MV” has been selected is displayed on the sub screen of the multi view display, the images are looped as if two mirrors were facing each other.

2. Input/output signal settings

2-5-2. Setting the split frame and characters

Set the frame, character brightness and background of the split screens to be displayed on the multi view display.

- ① Press the  button to light its indicator, and display the Multi View Display menu.
- ② Use [F1] to display the MV Frame sub menu.

MENU : Multi View Display				
MV Frame	Frame	Character	Label	Tally
	LUM75%	LUM75%	Off	On
				Red+Green

- ③ Use [F2] to set the split frame brightness and split frame display using the Frame item.

LUM0%, LUM25%, LUM50%, LUM75%, LUM100%	Select one of these settings for the brightness of the split frame (gray scale).
Off	The split frame is not displayed.

- ④ Use [F3] to set the character brightness and character display using the Character item.

LUM0%, LUM25%, LUM50%, LUM75%, LUM100%	Select one of these character (gray scale) brightness settings.
Off	The characters are not displayed. Neither is the character background shown.

- ⑤ Use [F4] to set whether the character background (half-tone) is to be displayed using the Label item.

On	The character background is displayed.
Off	The character background is not displayed.

2-5-3. Setting the tally displays

Set the tally displays to be superimposed onto the split frame of the multi view display.

The red tally indicates material consisting of program outputs. The green tally indicates material selected by the preset bus.

On the MV Frame sub menu, use [F5] to set the tally displays using the Tally item.

MENU : Multi View Display				
MV Frame	Frame	Character	Label	Tally
	LUM75%	LUM75%	Off	On
				Red+Green

Red+Green	Both the red tally and green tally are displayed.
Red	Only the red tally is displayed.
Off	No tally displays are shown.

- The red tally is not displayed during FTB operation while the program images have been completely faded out to a black screen. At this time, the green tally is displayed for images consisting of program images. However, the red tally is displayed when a setting other than "White" or "Black" has been selected for the image used for fading out.
 - ☞ Refer to "1-7. FTB (Fade to Black)".
- The red tally and green tally signals are output from the tally output connector on the rear panel.
 - ☞ Refer to "4-1. Setting the GPI I/O".

2. Input/output signal settings

2-5-4. Changing the material names

The material names of the input signals (SDI IN1 to SDI IN8, DVI IN, IN-A1, IN-A2, IN-B1 or IN-B2) to be set on the multi view display can be changed.

These names can be selected from the default settings or user settings.

When the preset settings and user settings are established, the material name (CAM1, etc.) is displayed.

- ① On the Input sub menu, use [F2] to select the input to be set using the Select item.
☞ Refer to “2-1. Input signal settings”.

- ② Use [F1] to display the Name sub menu.

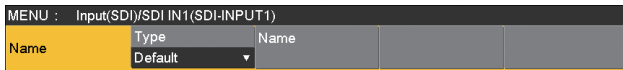

- ③ Use [F2] to select the type of material names using the Type item.

Default (default settings)	Select the material names from the following: SDI IN1 to SDI IN8, DVI IN, IN-A1, IN-A2, IN-B1 and IN-B2.
User (user settings)	The material names are set using up to 7 characters.

Preset type setting procedure

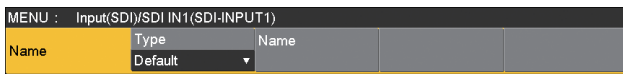

- ① On the Name sub menu, use [F2] to select “Preset” using the Type item.
- ② Use [F3] to select the material name using the Name item.

User type setting procedure

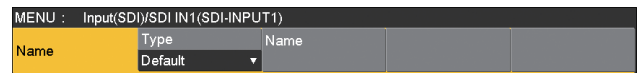

- ① On the Name sub menu, use [F2] to select “User” using the Type item.
- ② Press [F3] to display the keyboard screen.
- ③ Using [F1] to [F3], input the name, and press [F4]. To clear the name which has been input and close the keyboard screen, press [F5].
☞ Refer to “2-2-2. Keyboard screen operations” (<Basics> Operating Instructions).

2. Input/output signal settings

2-5-5. Setting the level meters

Level meters for the embedded audio signals transferred by the SDI input can be displayed on the split screens.

Left display:

Channel 1 of group 1

Right display:

Channel 2 of group 1

- ① Press the  button to light its indicator, and display the Multi View Display menu.
- ② Use [F1] to display the Display sub menu.

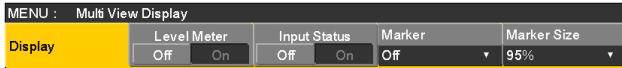

- ③ Use [F2] to set the level meter display using the Level Meter item.

On	The level meters are displayed.
Off	The level meters are not displayed.

2-5-6. Setting the input signal marks

The status of the input signals can be displayed in front of the material names displayed on the split screens.

“F” mark:

This appears when the input signals are frozen.

“!” mark:

This appears when no signals are input or when signals with different formats are input.

- When the “F” mark is displayed, the “!” mark is not displayed.
- ① On the Display sub menu, use [F3] to set the input signal status display using the Input Status item.

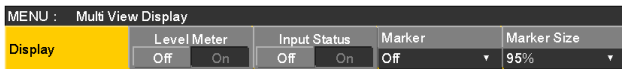

On	The input signal status is displayed.
Off	The input signal status is not displayed.

2-5-7. Setting the markers

Safety markers can be displayed for the multi view materials. The markers can be displayed when PGM or PVW materials are to be displayed in half their original size.

4Split	Sub screens 1 to 4
5/6/10Split	1 or 2 sub screens

- ① On the Display sub menu, use [F4] to set the marker display using the Marker item.

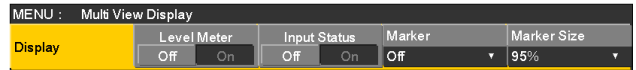

4:3	The markers are displayed using the 4:3 aspect ratio.
16:9	The markers are displayed using the 16:9 aspect ratio.
Off	The markers are not displayed.

- ② Use [F5] to set the size of the markers using the Marker Size item.

2-5-8. High-resolution multi view mode

The image output on a multi view display can be output in high resolution to DVI-D output.

- These settings can be established when the system mode is set to SD.

- ① Press the  button to light its indicator, and display the System menu.
- ② Use [F1] to display the Format sub menu.



- ③ Use [F3] to set “On” or “Off” using the Hi Resolution item, and press the [F3].
 - Turning this setting “On” switches the Source item to the default value if the following output signals in the Source item of the Assign submenu under the Output menu are set to “MV”.

SDI OUT1 to SDI OUT5, OUT-A1, OUT-A2, OUT-B1, OUT-B2

- Turning this setting “On”, while the multi view display signal is output to the AUX bus or DISP bus, switches the output signal to the black signal (internally generated signal).

2. Input/output signal settings

2-6. Setting the ancillary data and embedded audio data

A function for allowing the V ancillary data and embedded audio data of the SDI input signals to pass through can be set.

When an HD format is used:

The ancillary data starting with line 9 is allowed to pass through.

When an SD format is used:

The ancillary data starting with line 12 is allowed to pass through.

- When 1080/59.94i, 720/59.94p, 1080/50i or 720/50p has been selected as the unit's system format setting, it is not possible to allow the ancillary data and embedded audio data to pass through even if SD format signals (480/59.94i or 576/50i) have been input in the Dot by Dot mode or Up Convert mode.

☞ Refer to "2-1-2. Setting the input mode".

- Press the  button to light its indicator, and display the System menu.

- Use [F1] to display the Ancillary sub menu.



Setting for the program output signals

- Use [F3] to select "On" or "Off" using the PGM item.

On	The ancillary data and embedded audio data of the SDI input materials selected by the PGM bus are allowed to pass through.
Off	The ancillary data and embedded audio data are not allowed to pass through.

Setting for the preview output signals

- Use [F4] to select "On" or "Off" using the PVW item.

On	The ancillary data and embedded audio data of the SDI input materials selected by the PST bus are allowed to pass through.
Off	The ancillary data and embedded audio data are not allowed to pass through.

Setting for the output signals of the multi view display

- Use [F5] to select "PGM", "PVW" or "Off" using the MV item.

PGM	The ancillary data and embedded audio data of the SDI input materials selected by the PGM bus are allowed to pass through.
PVW	The ancillary data and embedded audio data of the SDI input materials selected by the PST bus are allowed to pass through.
Off	The ancillary data and embedded audio data are not allowed to pass through.

Setting for the output signals of the AUX buses (AUX1 to AUX4)

- Use [F2] to select "On" or "Off" using the AUX item.

On	The ancillary data and embedded audio data of the SDI input materials selected by the AUX bus (AUX1 to AUX4) are allowed to pass through.
Off	The ancillary data and embedded audio data are not allowed to pass through.

3. System settings

3-1. Setting the system format

One system format (input/output signal) can be selected.

- ① Press the  button to light its indicator, and display the System menu.
- ② Use [F1] to display the Format sub menu.



- ③ Use [F2], select the format using the Format item, and press the [F2] to enter the selection.

Setting the 16:9 squeeze mode

When the 16:9 squeeze mode is selected, a border width (wipe or PinP) is established that considers cases where SD format images are to be converted into the 16:9 aspect ratio and used.

This setting is possible when SD is selected as the system format setting.

On the Format sub menu, use [F4] to select whether to support the squeeze mode using the 16:9 Squeeze item.

On	The squeeze mode is supported.
Off	The squeeze mode is not supported.

Border width (graphical representation) when the squeeze mode is supported

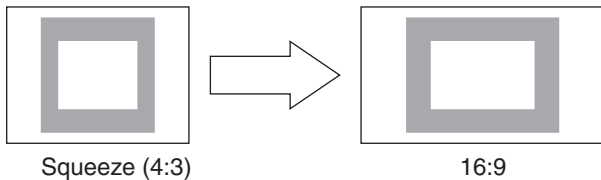

3. System settings

3-2. Setting the crosspoints

3-2-1. Assigning signals to the crosspoints

External video input signals and internally generated signals can be assigned to crosspoint buttons 1 to 24.

When one of the crosspoint buttons 1 to 24 is held down, the status of the signal assigned is displayed on the built-in display while the button is held down.

Changing the current assignment of the signals selected by the crosspoint buttons will cause the positions of the lit crosspoint buttons to change to correspond with the assignment change. The images output at this time will remain unchanged.

The table below lists the materials which can be assigned.

Signal	What appears on the display	Description
SDI IN1 to SDI IN8	IN1 to IN8	SDI input 1 to 8
DVI IN	DVI	DVI-D input
IN-A1, IN-A2, IN-B1, IN-B2	A1, A2, B1, B2	Option slot (SDI, analog component, analog composite and DVI)
Black	BLK	Internally generated signal (black)
CBGD1, CBGD2	CBD1, CBD2	Internally generated signal (color background)
CBAR	CBAR	Internally generated signal (color bar)
Still1V, Still1K, Still2V, Still2K	ST1V, ST1K, ST2V, ST2K	Still image video memory
Clip1V, Clip1K, Clip2V, Clip2K	CL1V, CL1K, CL2V, CL2K	Moving image video memory
MEM-PVW	MPV	Memory preview (AUX bus and built-in display images only)
AUX1 to AUX4	AUX1 to AUX4	AUX bus output (built-in display images only)
CLN	CLN	CLN (AUX bus and built-in display images only)
KeyOut	KOUT	KeyOut (AUX bus and built-in display images only)
Shift	SHIFT	SHIFT function
None	None	No assignment

- The image will not be changed by pressing any button to which “None” is assigned.

The table below lists the default settings.

Button	What appears on the display	Button	What appears on the display	Button	What appears on the display
XPT1	BLK	XPT9	IN8	XPT17	CBD1
XPT2	IN1	XPT10	DVI	XPT18	ST1V
XPT3	IN2	XPT11	A1	XPT19	ST2V
XPT4	IN3	XPT12	None	XPT20	None
XPT5	IN4	XPT13	A2	XPT21	KOUT
XPT6	IN5	XPT14	B1	XPT22	CLN
XPT7	IN6	XPT15	B2	XPT23	None
XPT8	IN7	XPT16	CBAR	XPT24	None

3. System settings

3-2-2. Setting the crosspoint switching

The timing at which the crosspoints are to be switched can be set.

This switching involves the operations of the crosspoint buttons and [Cut] button.

- ① Press the  button to light its indicator, and display the XPT menu.
- ② Use [F1] to display the XPT Switch sub menu.



- ③ Use [F2], and select the switching timing using the Timing item.

Any	The crosspoints are switched in the nearest field. This is suited to live applications.
Field1	The crosspoints are switched in field 1. This is suited to editing applications.
Field2	The crosspoints are switched in field 2. This is suited to editing applications.

3. System settings

3-3. Button assignments

3-3-1. Setting the user buttons

The user can assign several functions which can be set using the menu items into eight user buttons (U1 to U8).

The user buttons light in amber when the assigned function is ON and are off when the assigned function is OFF.

Each time the user button is pressed, the function setting alternates between ON and OFF.

The table below lists the functions which can be assigned to the user buttons (U1 to U8).

Function name	Description of function
Key PVW	Output the key image to the preview output.
PinP PVW	Outputs the PinP1 and PinP2 images simultaneously to the preview output.
PinP1 PVW	Output the PinP1 image to the preview output.
PinP2 PVW	Output the PinP2 image to the preview output.
DSK PVW	Output the DSK image to the preview output.
GPII-EN	Enables or disables GPI-In.
GPIO-EN	Enables or disables GPI-Out.
SHIFT	Switches all the A/B bus and AUX bus crosspoints between front and rear.
AUX Trans	Enables or disables the AUX bus transitions.
PinP Trans	Enables or disables the PinP bus transitions.
EFF DSLV	Switches effect dissolve between ON and OFF.

■ Default settings

Button	Function name	Button	Function name
U1	KEY PVW	U5	AUX Trans
U2	PinP PVW	U6	EFF DSLV
U3	DSK PVW	U7	SHIFT
U4	PinP Trans	U8	None

- When a plug-in software application is introduced, the functions inherent to that application are sometimes added as the functions which are assigned.*

*: This function can be actuated in any model whose system version is V2.00.00 and up.
These operations cannot be performed in a model with a system version of below V2.00.00.

<Setting method>

- ① Press the  button to light its indicator, and display the Config menu.
- ② Use [F1] to display the User Button1 sub menu and User Button2 sub menu.

● User Button1 sub menu

MENU : Config	User1	User2	User3	User4
User				
Button1	KEY PVW	PinP PVW	DSK PVW	PinP Trans

- ③ Use [F2] to select the function to be assigned to the [U1] button using the User1 item.
- ④ Use [F3] to select the function to be assigned to the [U2] button using the User2 item.
- ⑤ Use [F4] to select the function to be assigned to the [U3] button using the User3 item.
- ⑥ Use [F5] to select the function to be assigned to the [U4] button using the User4 item.

● User Button2 sub menu

MENU : Config	User5	User6	User7	User8
User				
Button2	AUX Trans	EFF DSLV	SHIFT	None

- ⑦ Use [F2] to select the function to be assigned to the [U5] button using the User5 item.
- ⑧ Use [F3] to select the function to be assigned to the [U6] button using the User6 item.
- ⑨ Use [F4] to select the function to be assigned to the [U7] button using the User7 item.
- ⑩ Use [F5] to select the function to be assigned to the [U8] button using the User8 item.

3. System settings

3-4. Setting the date and time

The user can set the date and time to be used as the memory card's time stamp.

Be absolutely sure to set them when a memory card is to be used.

Setting the date

- 1 Press the  button to light its indicator, and display the System menu.
- 2 Use [F1] to display the Date sub menu.

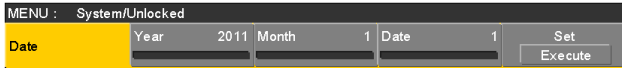

- 3 Use [F2] to set the year using the Year item.
- 4 Use [F3] to set the month using the Month item.
- 5 Use [F4] to set the day using the Date item.
- 6 Press the [F5] to enter the year/month/day.

Setting the time

- 1 On the System menu, use [F1] to display the Time sub menu.

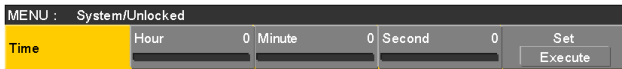

- 2 Use [F2] to set the hour using the Hour item.
- 3 Use [F3] to set the minutes using the Minute item.
- 4 Use [F4] to set the seconds using the Second item.
- 5 Press the [F5] to enter the hour/minutes/seconds.

3-5. Network settings

Proceed with the network settings to perform such tasks as updating the software version via LAN.

The network initial setup is: IP address: 192.168.0.8, subnet mask: 255.255.255.0.

When using the host computer with settings matching the initial setup, it is not necessary to setup via the menu.

For the setting to take effect, the system must be rebooted. Turn the system's power off and then back on.

Setting the IP address

- 1 Press the  button to light its indicator, and display the System menu.
- 2 Use [F1] to display the Network1 sub menu.



- 3 Use [F2] to [F5] to set the IP address, and press the [F5] (Save) to enter the address.

Setting the subnet mask

- 1 On the System menu, use [F1] to display the Network2 sub menu.



- 2 Use [F2] to [F5] to set the subnet mask, and press the [F5] (Save) to enter the mask.

Setting the gateway

- 1 On the System menu, use [F1] to display the Network3 sub menu.



- 2 Use [F2] to [F5] to set the gateway, and then press [F5] (Save) to enter the setting.

Display the MAC address

- 1 On the System menu, use [F1] to display the Network4 sub menu.
The MAC address now appears.

3. System settings

3-6. Setting the built-in display backlight and button illumination

Setting the built-in display backlight

The built-in display backlight can be set to ON or OFF. It is also possible to automatically turn off the built-in display backlight when no control panel operation is performed within a set time interval.

- ① Press the  button to light its indicator, and display the Config menu.
- ② Use [F1] to display the LCD BL sub menu.

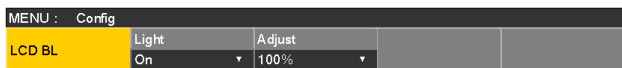

- ③ Use [F2] to select the setting for the backlight using the Light item.

On	Backlight is turned on all the time.
Off	The backlight turns off as soon as "Off" is selected as the setting. It lights up when the control panel is operated. (The "On" status is selected as the setting.)
60, 120, 180	When no control panel operation is performed within a set time interval (60 minutes, 120 minutes, 180 minutes), the built-in display backlight is turned off automatically. Even when the set time interval elapses and the display backlight is turned off, the backlight comes back on when a control panel operation is performed.

- ④ Use [F3] to set the brightness of the backlight using the Adjust item.

Setting the button illumination

The button indicators in the areas listed below can be kept illuminated all the time.

It is then easier to read the characters displayed on the buttons even when the unit is operated in dark places.

- Memory/wipe pattern/number key area
- User button area
- Display area

- ① Press the  button to light its indicator, and display the Config menu.
- ② Use [F1] to display the Button Illumination sub menu.

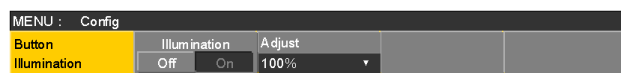

- ③ Use [F2] to set the illumination of the button indicators using the Illumination item.

On	The button indicators are illuminated.
Off	The button indicators are not illuminated.

- ④ Use [F3] to set the brightness of the illumination using the Adjust item.

3. System settings

3-7. Status displays

3-7-1. Alarm status displays

The alert status (alarms) for this unit's power supply and cooling fan are displayed on the built-in display.

- ① Press the  button to light its indicator, and display the System menu.
- ② Use [F1] to display the Alarm sub menu.

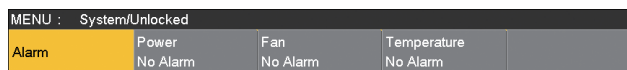

MENU : System/Unlocked			
Alarm	Power	Fan	Temperature
	No Alarm	No Alarm	No Alarm

The alert status of the power supplies is displayed in the Power item.

The alert status of the cooling fan is displayed in the Fan item.

The alert status of the internal temperature is displayed in the Temperature item.

No Alarm	No irregularity
Alarm	Irregularity

3-7-2. Alarm message

A message is displayed on the built-in display when an alarm has occurred.

Alarm message displayed	Type of trouble	Operation
ALARM ! Fan Stop	Shutdown of the cooling fan	When OK is pressed, the alarm message is cleared. ● Contact your dealer immediately.
ALARM ! Power Failure	Drop in the supply voltage	
ALARM ! Temperature	Rise in the temperature inside the unit	

3. System settings

3-7-3. Displaying the version information and option information

Information on the unit's software and hardware versions and the versions of the options are displayed.

Displaying the version information

- ① Press the  button to light its indicator, and display the System menu.
- ② Use [F1] to display the Main Version sub menu.

MENU : System/Unlocked				
Main Version	System Version	Module Type	Select	Version
	1.00.00	Soft	Main1	1.00.00

- The unit's system version information is displayed in the System Version item.
- ③ Use [F3] to select the type (Soft or FPGA) of the version to be displayed using the Module Type item.
 - The item of the module that corresponds to the selected type can be selected as the Select item using [F4].
When [F4] is used, the version of the selected item is displayed in the Version item of [F5].

Displaying the option version information

- ④ Use [F1] to display the Option Version sub menu.

MENU : System/Unlocked			
Option Version	Select	Board	Version
	SLOTA	SDI-IN	V 1.00.00

- ⑤ Use [F2] to select the option slot using the Select item.

SLOT A	Option slot A
SLOT B	Option slot B

- ⑥ The types of the option boards connected are displayed in the Board item.
- ⑦ The option board version information is displayed in the Version item.

3. System settings

3-8. Initialization

3-8-1. Initializing setting data

Initialization returns the set data to the factory shipment status.

The user can select one of two modes in which to initialize the data, namely, "Mode A" or "Mode B".

<Items and data which are not initialized>

- All plug-in menus
(In "Mode A", these menus are initialized.)
- The items of the System menu listed below:
Network1, Network2, Network3, Date, Time

① Press the  button to light its indicator and display the System menu.

② Use [F1] to display the Initial sub menu.



③ Use [F2] to select the initialization mode ("Mode A" or "Mode B").

④ Press [F2] to proceed with the initializing.

- Once initialization has been completed the power of the unit shuts off and turns back on again automatically.

3-8-2. Initializing fader

The range for executing a transition can be initialized by operating the fader lever.

Initialization should be performed when transitions are not completed to the end even when the fader lever has been moved as far as it will go.

① Press [F3] in the Initial sub menu to perform initialization.



② When initializing, use [F3] to select "Yes" and press the [F3].

When not initializing, use [F3] to select "No" and press the [F3].

4. External interfaces

4-1. Setting the GPI I/O

The user can set the functions that are to be controlled from the GPI ports and set whether to enable the control.

- ① Press the  button to light its indicator, and display the Config menu.
- ② Use [F1] to display the GPI-In Setting sub menu (or GPI-Out Setting sub menu).

MENU : Config			
GPI-In Setting	GPI-In Enable	AUX Sel	
	Off On	AUX1	

MENU : Config			
GPI-Out Setting	GPI-Out Enable	AUX Sel	
	Off On	AUX1	

- ③ Use [F2] to set “On” or “Off” for the control to be exercised from the ports using the GPI-In Enable item (or GPI-Out Enable item).
- ④ Use [F3] to set the AUX bus to be used to notify the tally using the AUX Sel item.
- ⑤ Use [F1] to display GPI-In Port 1/2 sub menu and GPI-In Port 2/2 sub menu (or GPI-Out Port 1/5 sub menu to GPI-Out Port 5/5 sub menu).

MENU : Config				
GPI-In Port 1/2	Port1Assign	Port2Assign	Port3Assign	Port4Assign
	No Assign	No Assign	No Assign	No Assign

MENU : Config				
GPI-In Port 2/2	Port5Assign	Port6Assign	Port7Assign	Port8Assign
	No Assign	No Assign	No Assign	No Assign

MENU : Config				
GPI-Out Port 1/5	Port1Assign	Port2Assign	Port3Assign	Port4Assign
	No Assign	No Assign	No Assign	No Assign

MENU : Config				
GPI-Out Port 2/5	Port5Assign	Port6Assign	Port7Assign	Port8Assign
	No Assign	No Assign	No Assign	No Assign

MENU : Config				
GPI-Out Port 3/5	Port9Assign	Port10Assign	Port11Assign	Port12Assign
	No Assign	No Assign	No Assign	No Assign

MENU : Config				
GPI-Out Port 4/5	Port13Assign	Port14Assign	Port15Assign	Port16Assign
	No Assign	No Assign	No Assign	No Assign

MENU : Config				
GPI-Out Port 5/5	Port17Assign	Port18Assign	Port19Assign	
	No Assign	No Assign	No Assign	

- ⑥ Use [F2] to [F5] to allocate the functions to be assigned to the respective pin numbers.
 - ☞ Refer to “Control using the GPI Input port” and “Output from the GPI Output port”.
- Settings for the GPI-In Enable (or GPI-Out Enable) item can be assigned to one of the user buttons.
 - ☞ Refer to “3-3-1. Setting the user buttons”.

4. External interfaces

■ Control using the GPI Input port

Assign Item	Description of function assigned	Control method
AUTO	AUTO button in transition area	Operations are performed using contact inputs (30 ms or more).
CUT	CUT button in transition area	
KEY ON	KEY ON button in transition area	
DSK ON	DSK ON button in transition area	
PinP1 ON	PinP1 ON button in transition area	
PinP2 ON	PinP2 ON button in transition area	
FTB	FTB button in transition area	
BKGD AUTO	AUTO button when the background is selected	
BKGD CUT	CUT button when the background is selected	
KEY AUTO	AUTO button when the key is selected	
KEY CUT	CUT button when the key is selected	
REC Still1	Still1 recording	
REC Still2	Still2 recording	
REC Clip1	Clip1 recording start	
REC Clip2	Clip2 recording start	
STOP Clip1	Clip1 recording stop or playback stop	
STOP Clip2	Clip2 recording stop or playback stop	
PLAY Clip1	Clip1 playback start	
PLAY Clip2	Clip2 playback start	
AUX XPT 1 to 24	Crosspoint buttons (1 to 24) used to switch the AUX buses. • Select the AUX buses (AUX1 to AUX4) to be controlled using the menu.	
REDTly DSBL	Red tally signal is not output	Functions are enabled using contact inputs (or disabled in open status).
GRNTly DSBL	Green tally signal is not output	
AUXTly DSBL	AUX tally signal is not output	
No Assign	No function assigned	

- When a plug-in software application is introduced, the functions inherent to that application are sometimes added as the functions which are assigned.*

*: This function can be actuated in any model whose system version is V2.00.00 and up.
These operations cannot be performed in a model with a system version of below V2.00.00.

4. External interfaces

■ Output from the GPI Output port

Assign Item	Description of function assigned	Output
CUT	Cut transition executed	Low pulses are output (approx. 50 to 60 ms).
KEY ON	Key transition start	
DSK ON	DSK transition start	
PinP1 ON	PinP1 transition start	
PinP2 ON	PinP2 transition start	
FTB ON	FTB transition start	
BKGD CUT	Cut transition for the background executed	
KEY CUT	Cut transition for a key executed	
EVENTMEM	Event set by event memory executed	
AUTO	Auto transition execution in progress	A low level is output.
BKGD AUTO	Auto transition execution in progress for background	
KEY AUTO	Auto transition execution in progress for key	
KEY Trans	Transition execution in progress for key	
DSK Trans	Transition execution in progress for DSK	
PinP1 Trans	Transition execution in progress for PinP1	
PinP2 Trans	Transition execution in progress for PinP2	
FTB Trans	Transition execution in progress for FTB	
REDTly1 to 13	Red tally for INPUT1 to INPUT13*1	A low level is output during tally output.
GRNTly1 to 13	Green tally for INPUT1 to INPUT13*1	
AUXTly1 to 13	When INPUT1 to INPUT13*1 have been selected by the AUX bus ● Select the AUX buses (AUX1 to AUX4) whose signals are to be output using the menu.	A low level is output while the inputs are selected.
No Assign	No function assigned	

*1: The following inputs are used for INPUT1 to INPUT13.

- INPUT1 to INPUT8: SDI IN1 to SDI IN8
 - INPUT9: DVI IN
 - INPUT10, INPUT11: IN A1, IN A2
 - INPUT12, INPUT13: IN B1, IN B2
- When a plug-in software application is introduced, the functions inherent to that application are sometimes added as the functions which are assigned.*2

*2: This function can be actuated in any model whose system version is V2.00.00 and up.
These operations cannot be performed in a model with a system version of below V2.00.00.

4. External interfaces

Example of GPI Out and ALARM connections

Ensure that the conditions given below are satisfied.

Dielectric strength: Max. DC 24 V
 Current: Max. 50 mA

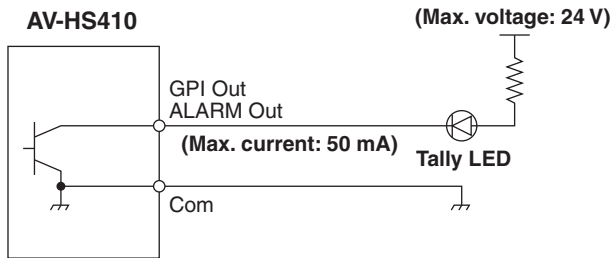

Example of GPI In connections

Provide contact inputs.

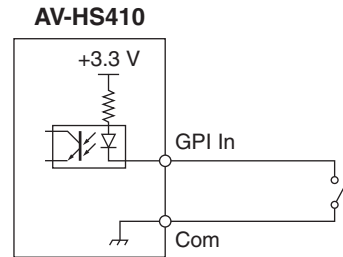

TALLY/GPI 1

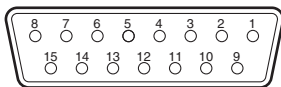

TALLY/GPI 2

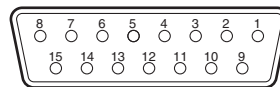

Pin No.	Signal name
1	GPI-Out1
9	GPI-Out9
2	GPI-Out2
10	ALARM Out
3	GPI-Out3
11	GPI-In1
4	GPI-Out4
12	GPI-In2
5	GPI-Out5
13	GPI-In3
6	GPI-Out6
14	GPI-In4
7	GPI-Out7
15	GPI-Com
8	GPI-Out8

Pin No.	Signal name
1	GPI-Out10
9	GPI-Out18
2	GPI-Out11
10	GPI-Out19
3	GPI-Out12
11	GPI-In5
4	GPI-Out13
12	GPI-In6
5	GPI-Out14
13	GPI-In7
6	GPI-Out15
14	GPI-In8
7	GPI-Out16
15	GPI-Com
8	GPI-Out17

4. External interfaces

4-2. LAN

Connect the unit and computer or the unit and an external device*.

*: An external device can be controlled from the unit.

- Use a crossover cable (category 5 or above) when connecting the equipment directly.
- Use a straight cable (category 5 or above) when connecting the equipment through a hub (switching hub).
- It supports plug-in software.

4-3. EDITOR

The unit can be controlled by an external device by connecting the device to the EDITOR connector.

- It supports plug-in software.

Use it with the settings below.

Baud rate: 38400 bps
Character length: 8 bit
Parity: Odd
Stop bit: 1 bit
Flow control: None

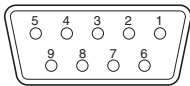

RS-422, D-sub 9-pin, female, inch screw

Pin No.	Signal name	Description of signal
1	FRAME GROUND	Frame ground
2	TXD -	Send data (-)
3	RXD +	Receive data (+)
4	GROUND	Ground
5	NC	Not used
6	GROUND	Ground
7	TXD +	Send data (+)
8	RXD -	Receive data (-)
9	FRAME GROUND	Frame ground

4-4. COM

An external device can be controlled from the unit.

- It supports plug-in software.

The communication system can be selected using the setting menu.

- ① Press the  button to light its indicator, and display the Config menu.
- ② Use [F1] to display the COM-Port sub menu.



- ③ Use [F2] to select the communication system using the Mode item.

	Mode: 1 (default setting)	Mode: 2	Mode: 3
Baud rate	9600 bps	38400 bps	38400 bps
Character length	8 bit	8 bit	8 bit
Parity	None	Odd	None
Stop bit	1 bit	1 bit	1 bit
Flow control	None	None	None

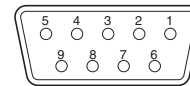

RS-422, D-sub 9-pin, female, inch screw

Pin No.	Signal name	Description of signal
1	FRAME GROUND	Frame ground
2	RXD -	Receive data (-)
3	TXD +	Send data (+)
4	GROUND	Ground
5	NC	Not used
6	GROUND	Ground
7	RXD +	Receive data (+)
8	TXD -	Send data (-)
9	FRAME GROUND	Frame ground

- The pin assignment is different from that of the EDITOR connector.

4. External interfaces

4-5. Plug-in software

This unit enables plug-in software to be registered and its functions to be added.

- For detailed information regarding the plug-in software, ask the dealer from whom you purchased your unit.

■ Registering a plug-in

The plug-in software can be loaded from a memory card, and registered in the unit.

☞ Refer to “1-12-3. Loading data from memory cards”.

When the plug-in software is registered, separate menu operations can be performed.

It is also possible to delete plug-in software which has been registered.

■ Opening the separate menu of the plug-in

- ① Press the  button to light its indicator, and display the Plug-in menu.
- ② Use [F1] to select the plug-in software.
 - The plug-in name of the plug-in software registered is displayed on the sub menu.

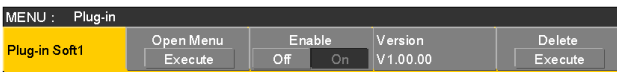

- ③ Press [F2] to open the menu of the plug-in software.

■ Plug-in startup setting

This setting determines whether the plug-in software is to be started up when the unit is started up.

On the “plug-in name” sub menu, use [F3] to establish the setting at startup using the Enable item.



On	The plug-in software is started up when the unit is started up.
Off	The plug-in software is not started up when the unit is started up.

- The plug-in startup setting takes effect when the unit is next started up.

■ Version information

The plug-in software version is displayed in the Version item of the “plug-in name” sub menu.



■ Deleting plug-in software

- ① Press the  button to display the Plug-in menu.
- ② Use [F1] to display the “plug-in name” sub menu whose plug-in software is to be deleted, and press [F5].

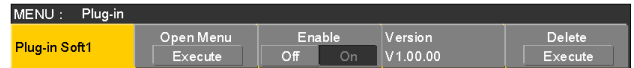

- The line of the selected “plug-in name” sub menu changes to a light gray display (it is grayed out).
- The plug-in software in question is deleted when the unit is next started up.

■ Plug-in software registration information

If the [MENU MODE] button of the display is pressed to set the display mode to “Menu display/Subscreen/Image display” when the Plug-in menu is displayed, the registration information of the plug-in software applications is displayed in the form of a list on the built-in display.

- The user can verify which plug-in software has been registered at which number on the Plug-in List.

Plug-in List		
No.	Plug-in name	Version
1	Plug-in 1	0.00
2	(No File)	
3	Plug-in 3	0.00
4	(No File)	
5	Plug-in 5	0.00
6	(No File)	
7	(No File)	
8	(No File)	
9	(No File)	
10	(No File)	

5. Setting menu table

- Settings for items indicated with (↓) are reflected when the item is selected and [F2], [F3], [F4] or [F5] is pressed.

Menu	Sub menu	Parameter	Parameter 1	Parameter 2	Parameter 3	Parameter 4
	Use [F1] to select.		Use [F2] to select.	Use [F3] to select.	Use [F4] to select.	Use [F5] to select.
Background	Border	Parameter	Border	Width	Soft	
		Setting range	On, Off	0.1 to 100.0	0.0 to 100.0	
		Default value	Off	5.0	0.0	
	Border Color	Parameter	Hue	Sat	Lum	Load (↓)
		Setting range	0.0 to 359.9	0.0 to 100.0	0.0 to 108.0	White, Yellow, Cyan, Green, Magenta, Red, Blue, Black
		Default value	0.0	0.0	100.0	White
	WIPE Position	Parameter	X-Pos	Y-Pos		Copy To Key
		Setting range	-100.00 to 100.00	-100.00 to 100.00		Execute
		Default value	0.00	0.00		
	SQ Position	Parameter	X-Pos	Y-Pos		Copy To Key
		Setting range	-100.00 to 100.00	-100.00 to 100.00		Execute
		Default value	0.00	0.00		
	Modify	Parameter	Trim	4:3 Auto		
		Setting range	Off, 16:9(On), 4:3, 4:3Smth	On, Off (Selection enabled when HD format is used)		
		Default value	Off	Off		
	3D Modify	Parameter	Light	Size	Radius	Angle
		Setting range	On, Off	0.0 to 100.0	0.000 to 1.000	-45 to +45
		Default value	Off	100.0	0.500	0

5. Setting menu table

Menu	Sub menu		Parameter 1	Parameter 2	Parameter 3	Parameter 4
	Use [F1] to select.		Use [F2] to select.	Use [F3] to select.	Use [F4] to select.	Use [F5] to select.
Color Background	CBGD1 Main	Parameter	Hue	Sat	Lum	Load (↓)
		Setting range	0.0 to 359.9	0.0 to 100.0	0.0 to 108.0	White, Yellow, Cyan, Green, Magenta, Red, Blue, Black
		Default value	120.0	100.0	100.0	Blue
	CBGD1 Sub	Parameter	Hue	Sat	Lum	Load (↓)
		Setting range	0.0 to 359.9	0.0 to 100.0	0.0 to 108.0	White, Yellow, Cyan, Green, Magenta, Red, Blue, Black
		Default value	0.0	0.0	100.0	White
	CBGD1 Wash	Parameter	Wash	Color	R-Sat	R-Lum
		Setting range	On, Off	Dual, Rainbow	0.0 to 100.0	0.0 to 108.0
		Default value	Off	Dual	100.0	100.0
	CBGD1 Wave	Parameter	Pattern	Cycle	Phase	Angle
		Setting range	Sine, Saw	0 to 100	-180.0 to 180.0	0.0 to 360.0
		Default value	Sine	0	0.0	0.0
	CBGD1 Move	Parameter	Move	Speed		
		Setting range	Off, Roll, Rotation	-50.0 to 50.0		
		Default value	Off	1.0		
	CBGD2 Main	Parameter	Hue	Sat	Lum	Load (↓)
		Setting range	0.0 to 359.9	0.0 to 100.0	0.0 to 108.0	White, Yellow, Cyan, Green, Magenta, Red, Blue, Black
		Default value	0.0	100.0	100.0	Red
	CBGD2 Sub	Parameter	Hue	Sat	Lum	Load (↓)
		Setting range	0.0 to 359.9	0.0 to 100.0	0.0 to 108.0	White, Yellow, Cyan, Green, Magenta, Red, Blue, Black
		Default value	0.0	0.0	100.0	White
	CBGD2 Wash	Parameter	Wash	Color	R-Sat	R-Lum
		Setting range	On, Off	Dual, Rainbow	0.0 to 100.0	0.0 to 108.0
		Default value	Off	Dual	100.0	100.0
	CBGD2 Wave	Parameter	Pattern	Cycle	Phase	Angle
		Setting range	Sine, Saw	0 to 100	-180.0 to 180.0	0.0 to 360.0
		Default value	Sine	0	0.0	0.0
	CBGD2 Move	Parameter	Move	Speed		
	Setting range	Off, Roll, Rotation	-50.0 to 50.0			
	Default value	Off	1.0			

5. Setting menu table

Menu	Sub menu	Parameter 1	Parameter 2	Parameter 3	Parameter 4	
	Use [F1] to select.					Use [F2] to select.
Key	Key	Parameter	Type	Lum Key	Fill	PVW
		Setting range	Lum, Linear, Chroma, Full	Chroma On, Chroma Off	Bus, Matte	Auto, Off, On
		Default value	Linear	Chroma Off	Bus	Auto
	Adjust	Parameter	Clip	Gain	Density	Invert
		Setting range	0.0 to 108.0	0.0 to 200.0	0.0 to 100.0	On, Off
		Default value	0.0	100.0	100.0	Off
	Fill Matte	Parameter	Hue	Sat	Lum	Load (↓)
		Setting range	0.0 to 359.9	0.0 to 100.0	0.0 to 108.0	White, Yellow, Cyan, Green, Magenta, Red, Blue, Black
		Default value	0.0	0.0	100.0	White
	Edge1	Parameter	Type	Width	Direction	Density
		Setting range	Off, Border, Drop, Shadow, Outline	0 to 4	0, 45, 90, 135, 180, 225, 270, 315	25, 50, 75, 100%
		Default value	Off	2	0	100%
	Edge2	Parameter	Edge Fill			
		Setting range	Color, CBGD1, CBGD2, Still1, Still2, Clip1, Clip2			
		Default value	Color			
	Edge Color	Parameter	Hue	Sat	Lum	Load (↓)
		Setting range	0.0 to 359.9	0.0 to 100.0	0.0 to 108.0	White, Yellow, Cyan, Green, Magenta, Red, Blue, Black
		Default value	0.0	0.0	0.0	Black
	Transition	Parameter	Keyout Pattern			
		Setting range	Normal, Reverse			
		Default value	Normal			
	WIPE Position	Parameter	X-Pos	Y-Pos		Copy To BKGD
		Setting range	-100.00 to 100.00	-100.00 to 100.00		Execute
		Default value	0.00	0.00		
	SQ Position	Parameter	X-Pos	Y-Pos		Copy To BKGD
		Setting range	-100.00 to 100.00	-100.00 to 100.00		Execute
		Default value	0.00	0.00		
	Flying Key	Parameter	X-Pos	Y-Pos	Size	
		Setting range	-100.00 to 100.00	-100.00 to 100.00	0.0 to 400.0	
		Default value	0.00	0.00	100.0	
3D Modify	Parameter	Light	Size	Radius	Angle	
	Setting range	On, Off	0.0 to 100.0	0.000 to 1.000	-45 to +45	
	Default value	Off	100.0	0.500	0	

5. Setting menu table

Menu	Sub menu		Parameter 1	Parameter 2	Parameter 3	Parameter 4
	Use [F1] to select.		Use [F2] to select.	Use [F3] to select.	Use [F4] to select.	Use [F5] to select.
Key	Mask	Parameter	Mask	Invert		
		Setting range	Off, Manual, 4:3	On, Off		
		Default value	Off	Off		
	Mask Adjust	Parameter	Left	Top	Bottom	Right
		Setting range	-50.00 to 50.00	-50.00 to 50.00	-50.00 to 50.00	-50.00 to 50.00
		Default value	-25.00	25.00	-25.00	25.00
	Key Priority	Parameter	Low	Middle	High	
	Setting range	Key, PinP1, PinP2	Key, PinP1, PinP2	Key, PinP1, PinP2		
	Default value	Key	PinP1	PinP2		
Chroma Key	Auto Compute	Parameter	Auto Compute			Reset
		Setting range	Execute			Execute
		Default value				
	Adjust	Parameter	Narrow	Phase		
		Setting range	Off, 0.5, 1.0, 1.5	-4.0 to 4.0		
		Default value	Off	0.0		
	Sample	Parameter	View	Mode		Undo
		Setting range	Composite, Matte, Proc.FG, FG	Select BG Color, Clean BG Noise, Clean FG Noise, Spill Sponge, Spill-, Spill+, Matte-, Matte+, Detail-, Detail+, Matte Sponge, Make FG Trans, Restore Detail, FineTuning		Execute
		Default value	Composite	Select BG Color		
	Fine Tuning	Parameter	Spill	Trans	Detail	
	Setting range	-1000 to 1000	-1000 to 1000	-1000 to 1000		
	Default value	0	0	0		

5. Setting menu table

Menu	Sub menu		Parameter 1	Parameter 2	Parameter 3	Parameter 4
	Use [F1] to select.		Use [F2] to select.	Use [F3] to select.	Use [F4] to select.	Use [F5] to select.
PinP1	PinP	Parameter	Shape	Density		PVW
		Setting range	Square, Circle, Heart, Flower, Star	0.0 to 100.0		On, Off
		Default value	Square	100.0		Off
	Border	Parameter	Border	Width	Soft	Mode
		Setting range	Off, On	0.1 to 100.0	0.0 to 100.0	Fix, Variable
		Default value	Off	5.0	0.0	Fix
	Border Color	Parameter	Hue	Sat	Lum	Load (↓)
		Setting range	0.0 to 359.9	0.0 to 100.0	0.0 to 108.0	White, Yellow, Cyan, Green, Magenta, Red, Blue, Black
		Default value	0.0	0.0	100.0	White
	Position	Parameter	X-Pos	Y-Pos	Size	
		Setting range	-100.00 to 100.00	-100.00 to 100.00	0.00 to 100.00	
		Default value	0.00	0.00	25.00	
	Trim	Parameter	Trim	Manual		
		Setting range	Off, 4:3, Manual (Fixed to "Off" when a setting other than Square has been selected for the Shape item of the PinP sub menu)	Free, Pair		
		Default value	Off	Free		
	Trim Adjust	Parameter	Left	Top	Bottom	Right
		Setting range	-50.00 to 50.00	-50.00 to 50.00	-50.00 to 50.00	-50.00 to 50.00
		Default value	-40.00	40.00	-40.00	40.00
	Sync	Parameter	Symmetry			Copy To PinP2
	Synchronizes with the PinP2 menu settings.	Setting range	Off, X, Y, Center			Execute
	Default value	Off				

5. Setting menu table

Menu	Sub menu		Parameter 1	Parameter 2	Parameter 3	Parameter 4
	Use [F1] to select.		Use [F2] to select.	Use [F3] to select.	Use [F4] to select.	Use [F5] to select.
PinP2	PinP	Parameter	Shape	Density		PVW
		Setting range	Square, Circle, Heart, Flower, Star	0.0 to 100.0		On, Off
		Default value	Square	100.0		Off
	Border	Parameter	Border	Width	Soft	Mode
		Setting range	Off, On	0.1 to 100.0	0.0 to 100.0	Fix, Variable
		Default value	Off	5.0	0.0	Fix
	Border Color	Parameter	Hue	Sat	Lum	Load (↓)
		Setting range	0.0 to 359.9	0.0 to 100.0	0.0 to 108.0	White, Yellow, Cyan, Green, Magenta, Red, Blue, Black
		Default value	0.0	0.0	100.0	White
	Position	Parameter	X-Pos	Y-Pos	Size	
		Setting range	-100.00 to 100.00	-100.00 to 100.00	0.00 to 100.00	
		Default value	0.00	0.00	25.00	
	Trim	Parameter	Trim	Manual		
		Setting range	Off, 4:3, Manual (Fixed to "Off" when a setting other than Square has been selected for the Shape item of the PinP sub menu)	Free, Pair		
		Default value	Off	Free		
	Trim Adjust	Parameter	Left	Top	Bottom	Right
		Setting range	-50.00 to 50.00	-50.00 to 50.00	-50.00 to 50.00	-50.00 to 50.00
		Default value	-40.00	40.00	-40.00	40.00
	Sync	Parameter	Symmetry			Copy To PinP1
	Synchronizes with the PinP1 menu settings.	Setting range	Off, X, Y, Center			Execute
	Default value	Off				

5. Setting menu table

Menu	Sub menu		Parameter 1	Parameter 2	Parameter 3	Parameter 4
	Use [F1] to select.		Use [F2] to select.	Use [F3] to select.	Use [F4] to select.	Use [F5] to select.
DSK	DSK	Parameter	Type	Lum Key	Fill	PVW
		Setting range	Lum, Linear	Chroma On, Chroma Off	Bus, Matte	On, Off
		Default value	Linear	Chroma Off	Bus	Off
	Adjust	Parameter	Clip	Gain	Density	Invert
		Setting range	0.0 to 108.0	0.0 to 200.0	0.0 to 100.0	On, Off
		Default value	0.0	100.0	100.0	Off
	Fill Matte	Parameter	Hue	Sat	Lum	Load (↓)
		Setting range	0.0 to 359.9	0.0 to 100.0	0.0 to 108.0	White, Yellow, Cyan, Green, Magenta, Red, Blue, Black
		Default value	0.0	0.0	100.0	White
	Edge1	Parameter	Type	Width	Direction	Density
		Setting range	Off, Border, Drop, Shadow, Outline	0 to 4	0, 45, 90, 135, 180, 225, 270, 315	25, 50, 75, 100%
		Default value	Off	2	0	100%
	Edge2	Parameter	Edge Fill			
		Setting range	Color, CBGD1, CBGD2, Still1, Still2, Clip1, Clip2			
		Default value	Color			
	Edge Color	Parameter	Hue	Sat	Lum	Load (↓)
		Setting range	0.0 to 359.9	0.0 to 100.0	0.0 to 108.0	White, Yellow, Cyan, Green, Magenta, Red, Blue, Black
		Default value	0.0	0.0	0.0	Black
	Mask	Parameter	Mask	Invert		
		Setting range	Off, Manual, 4:3	On, Off		
		Default value	Off	Off		
	Mask Adjust	Parameter	Left	Top	Bottom	Right
		Setting range	-50.00 to 50.00	-50.00 to 50.00	-50.00 to 50.00	-50.00 to 50.00
		Default value	-25.00	25.00	-25.00	25.00

5. Setting menu table

Menu	Sub menu		Parameter 1	Parameter 2	Parameter 3	Parameter 4
	Use [F1] to select.		Use [F2] to select.	Use [F3] to select.	Use [F4] to select.	Use [F5] to select.
Time	BKGD	Parameter	TransTime	Sec	Frame	
		Setting range		0 to 33 (When 59.94 Hz is selected)	0 to 999	
		Default value		1	0	
	Key	Parameter	TransTime	Sec	Frame	
		Setting range		0 to 33 (When 59.94 Hz is selected)	0 to 999	
		Default value		1	0	
	PinP1	Parameter	TransTime	Sec	Frame	
		Setting range		0 to 33 (When 59.94 Hz is selected)	0 to 999	
		Default value		1	0	
	PinP2	Parameter	TransTime	Sec	Frame	
		Setting range		0 to 33 (When 59.94 Hz is selected)	0 to 999	
		Default value		1	0	
	DSK	Parameter	TransTime	Sec	Frame	
		Setting range		0 to 33 (When 59.94 Hz is selected)	0 to 999	
		Default value		1	0	
	AUX1 BUS Trans	Parameter	TransTime	Sec	Frame	Transition
		Setting range		0 to 33 (When 59.94 Hz is selected)	0 to 999	Enable, Disable
		Default value		1	0	Disable
	PinP1 BUS Trans	Parameter	TransTime	Sec	Frame	Transition
		Setting range		0 to 33 (When 59.94 Hz is selected)	0 to 999	Enable, Disable
		Default value		1	0	Disable
	PinP2 BUS Trans	Parameter	TransTime	Sec	Frame	Transition
		Setting range		0 to 33 (When 59.94 Hz is selected)	0 to 999	Enable, Disable
		Default value		1	0	Disable
Effect Dissolve	Parameter	TransTime	Sec	Frame		
	Setting range		0 to 33 (When 59.94 Hz is selected)	0 to 999		
	Default value		1	0		
FTB	Parameter	TransTime	Sec	Frame		
	Setting range		0 to 33 (When 59.94 Hz is selected)	0 to 999		
	Default value		1	0		
Plug-in	The plug-in name of the plug-in software registered is displayed on the sub menu.	Parameter	Open Menu	Enable	Version	Delete
		Setting range	Execute	On, Off	Display only	Execute
		Default value		On		

5. Setting menu table

Menu	Sub menu		Parameter 1	Parameter 2	Parameter 3	Parameter 4
	Use [F1] to select.		Use [F2] to select.	Use [F3] to select.	Use [F4] to select.	Use [F5] to select.
Video Memory	Video Memory1	Parameter	Select	Rec	Play	Stop
		Setting range	Still1, Still2, Clip1, Clip2	Execute	Execute	Execute
		Default value	Still1			
	Video Memory2	Parameter	LEAD	LAST		
		Setting range	Execute	Execute		
		Default value				
	Video Memory3	Parameter	Total Time	Current time	Key	Rec Lock
		Setting range	The setting range differs from one format to another. 1080/59.94i: 00s01f to 20s00f 1080/50i: 00s01f to 24s00f 1080/24PsF: 00s01f to 25s00f 1080/23.98PsF: 00s01f to 25s00f 720/59.94p: 00s01f to 10s00f 720/50p: 00s01f to 12s00f 480/59.94i: 00s01f to 20s00f 576/50i: 00s01f to 24s00f		On, Off	On, Off
		Default value	00s01f	00s01f	Off	On
	Rec1	Parameter	Preview	V Source	Key Enable	Review
		Setting range	On, Off	AUX1 to 4	On, Off	On, Off
		Default value	Off	AUX1	On	On
	Rec2	Parameter	Loop	Quality	Limit (s)	Limit (f)
		Setting range	On, Off	High, Standard	0 to 20 (When 59.94i is selected)	0 to 600
		Default value	Off	Standard	20	0
	Clip1 Play Mode	Parameter	Mode	Reverse*	Variable*	Freeze
		Setting range	Lead, Last, Loop	On, Off	×1, ×2, ×4, ×8, ×1/2, ×1/4, ×1/8	Frame, Field
		Default value	Last	Off	×1	Frame
	Clip2 Play Mode	Parameter	Mode	Reverse*	Variable*	Freeze
		Setting range	Lead, Last, Loop	On, Off	×1, ×2, ×4, ×8, ×1/2, ×1/4, ×1/8	Frame, Field
		Default value	Last	Off	×1	Frame
	Trans Sync*	Parameter	Clip1	Clip2		
		Setting range	Off, KEY ON, PinP1 ON, PinP2 ON, DSK ON, FTB ON	Off, KEY ON, PinP1 ON, PinP2 ON, DSK ON, FTB ON		
		Default value	Off	Off		
	Memory*	Parameter	Mode	Select		Save
		Setting range	Auto, Manual	Still1, Still2, Clip1, Clip2, All		Execute
		Default value	Auto	All		

*: This function can be actuated in any model whose system version is V2.00.00 and up.
The functions are not displayed on the menus with a model whose system version is under V2.00.00.

5. Setting menu table

Menu	Sub menu		Parameter 1	Parameter 2	Parameter 3	Parameter 4
	Use [F1] to select.		Use [F2] to select.	Use [F3] to select.	Use [F4] to select.	Use [F5] to select.
SD Card	File1	Parameter	Mode (↓)	Save Type	File Name	Save
		Setting range	Load, Save, Init, Delete, No Card	Still1, Still2, Clip1, Clip2, Shot, Event, Set Up, All, Log		Execute
		Default value	No Card	All		
	File2	Parameter	Sort	Format		
		Setting range	Newest, Oldest, Name	bmp, tga, png, jpg, tif, gif		
		Default value	Name	bmp		
	Card Information	Parameter	Free Space			
		Setting range	0 / 0			
		Default value	Display only			
	Shot Memory	Store Select	Parameter	BKGD	Key	PinP1
		Setting range	On, Off	On,Off	On, Off	On, Off
		Default value	On	On	On	On
Recall Select		Parameter	BKGD	Key	PinP1	PinP2
		Setting range	On, Off	On,Off	On, Off	On, Off
		Default value	On	On	On	On
XPT Disable		Parameter	BKGD	Key	PinP1	PinP2
		Setting range	On, Off	On,Off	On, Off	On, Off
		Default value	Off	Off	Off	Off
Register		Parameter	Page	No.	Name	CopyTo (↓)
		Setting range	1 to 10	1 to 10		1 to 100
		Default value	1	1		1
Path		Parameter	Effect	PinP Bus	Hue Path	
		Setting range	Cut, Dissolve	Cut, Dissolve	Short, Long, CW, CCW	
		Default value	Dissolve	Dissolve	Short	
MEM PVW		Parameter	Mode			
	Setting range	MEM-PVW, PGM				
	Default value	PGM				

5. Setting menu table

Menu	Sub menu		Parameter 1	Parameter 2	Parameter 3	Parameter 4
	Use [F1] to select.		Use [F2] to select.	Use [F3] to select.	Use [F4] to select.	Use [F5] to select.
Event Memory	Mark	Parameter	PAUSE	CLIP	GPI-Out	
		Setting range	On, Off	Clip1, Clip2, Off	GPI-O1 to GPI-O19, Off	
		Default value	Off	Off	Off	
	Event Duration	Parameter	minute	second	frame	Set
		Setting range				Execute
		Default value	0	0	0	
	Total Duration	Parameter	minute	second	frame	Set
		Setting range				Execute
		Default value	0	0	0	
	Timeline	Parameter	View			
		Setting range	Normal, Wide			
		Default value	Wide			
	Run	Parameter	Run Mode			
		Setting range	Repeat, Loop			
		Default value	Repeat			
	Store Select	Parameter	BKGD	Key	PinP1	PinP2
		Setting range	On, Off	On,Off	On, Off	On, Off
		Default value	On	On	On	On
	Recall Select	Parameter	BKGD	Key	PinP1	PinP2
		Setting range	On, Off	On, Off	On, Off	On, Off
		Default value	On	On	On	On
	XPT Disable	Parameter	BKGD	Key	PinP1	PinP2
		Setting range	On, Off	On,Off	On, Off	On, Off
		Default value	Off	Off	Off	Off
	Register	Parameter	Page	No.	Name	CopyTo (↓)
		Setting range	1 to 10	1 to 10		1 to 100
		Default value	1	1		1
	Path	Parameter	Effect	PinP Bus	Trans Path	Hue Path
		Setting range	Cut, Dissolve	Cut, Dissolve	Linear, Step	Short, Long, CW, CCW, Step
		Default value	Dissolve	Dissolve	Linear	CW
	MEM PVW	Parameter	Mode			
		Setting range	MEM-PVW, PGM			
		Default value	PGM			

5. Setting menu table

Menu	Sub menu		Parameter 1	Parameter 2	Parameter 3	Parameter 4
	Use [F1] to select.		Use [F2] to select.	Use [F3] to select.	Use [F4] to select.	Use [F5] to select.
XPT	XPT Assign 1/6	Parameter	XPT1Signal	XPT2Signal	XPT3Signal	XPT4Signal
		Setting range	SDI IN1 to 8, DVI IN, IN-A1, IN-A2, IN-B1, IN-B2, Black, CBGD1, CBGD2, CBAR, Still1V, Still1K, Still2V, Still2K, Clip1V, Clip1K, Clip2V, Clip2K, MEM-PVW, CLN, KeyOut, None			
		Default value	Black	SDI IN1	SDI IN2	SDI IN3
	XPT Assign 2/6	Parameter	XPT5Signal	XPT6Signal	XPT7Signal	XPT8Signal
		Setting range	The setting range is the same as for the XPT Assign 1/6 sub menu.			
		Default value	SDI IN4	SDI IN5	SDI IN6	SDI IN7
	XPT Assign 3/6	Parameter	XPT9Signal	XPT10Signal	XPT11Signal	XPT12Signal
		Setting range	The setting range is the same as for the XPT Assign 1/6 sub menu.			
		Default value	SDI IN8	DVI IN	IN-A1	None
	XPT Assign 4/6	Parameter	XPT13Signal	XPT14Signal	XPT15Signal	XPT16Signal
		Setting range	The setting range is the same as for the XPT Assign 1/6 sub menu.			
		Default value	IN-A2	IN-B1	IN-B2	CBAR
	XPT Assign 5/6	Parameter	XPT17Signal	XPT18Signal	XPT19Signal	XPT20Signal
		Setting range	The setting range is the same as for the XPT Assign 1/6 sub menu.			
		Default value	CBGD1	Still1V	Still2V	None
	XPT Assign 6/6	Parameter	XPT21Signal	XPT22Signal	XPT23Signal	XPT24Signal
		Setting range	The setting range is the same as for the XPT Assign 1/6 sub menu.			
		Default value	KeyOut	CLN	None	None
	XPT Setting	Parameter	Shift	Shift-Lock		
		Setting range	Off, Right, Left	On, Off		
		Default value	Right	Off		
	XPT Switch	Parameter	Timing			
		Setting range	Any, Field1, Field2			
		Default value	Any			

5. Setting menu table

Menu	Sub menu	Parameter	Parameter 1	Parameter 2	Parameter 3	Parameter 4
	Use [F1] to select.		Use [F2] to select.	Use [F3] to select.	Use [F4] to select.	Use [F5] to select.
Multi View Display	MV Split	Parameter	Split			
		Setting range	4Split, 5-aSplit, 5-bSplit, 6-aSplit, 6-bSplit, 9Split, 10-aSplit, 10-bSplit, 16Split			
		Default value	10-aSplit			
	MV Pattern 1/4	Parameter	Pos1Signal	Pos2Signal	Pos3Signal	Pos4Signal
		Setting range	SDI IN1 to 8, DVI IN, IN-A1, IN-A2, IN-B1, IN-B2, CBGD1, CBGD2, Still1V, Still1K, Still2V, Still2K, Clip1V, Clip1K, Clip2V, Clip2K, PGM, PVW, MEM-PVW, Key Out, AUX1 to 4, Clock			
		Default value	PGM	PVW	SDI IN1	SDI IN2
	MV Pattern 2/4	Parameter	Pos5Signal	Pos6Signal	Pos7Signal	Pos8Signal
		Setting range	The setting range is the same as for the MV Pattern 1/4 sub menu.			
		Default value	SDI IN3	SDI IN4	SDI IN5	SDI IN6
	MV Pattern 3/4	Parameter	Pos9Signal	Pos10Signal	Pos11Signal	Pos12Signal
		Setting range	The setting range is the same as for the MV Pattern 1/4 sub menu.			
		Default value	SDI IN7	SDI IN8	DVI IN	Still1V
	MV Pattern 4/4	Parameter	Pos13Signal	Pos14Signal	Pos15Signal	Pos16Signal
		Setting range	The setting range is the same as for the MV Pattern 1/4 sub menu.			
		Default value	Still2V	Clip1V	Clip2V	AUX1
	MV Frame	Parameter	Frame	Character	Label	Tally
		Setting range	LUM0%, LUM25%, LUM50%, LUM75%, LUM100%, Off	LUM0%, LUM25%, LUM50%, LUM75%, LUM100%, Off	On, Off	Red, Red+Green, Off
		Default value	LUM75%	LUM75%	On	Red+Green
	Display	Parameter	Level Meter	Input Status	Marker	Marker Size
		Setting range	On, Off	On, Off	4:3, 16:9, Off	80 to 100%
	Default value	Off	On	Off	95%	

5. Setting menu table

Menu	Sub menu	Parameter	Parameter 1	Parameter 2	Parameter 3	Parameter 4	
	Use [F1] to select.		Use [F2] to select.	Use [F3] to select.	Use [F4] to select.	Use [F5] to select.	
Input	Input	Parameter	Select (↓)				
		Setting range	SDI IN1 to 8, DVI IN, IN-A1, IN-A2, IN-B1, IN-B2				
		Default value	SDI IN1				
Input (SDI) / X (***) <ul style="list-style-type: none"> • SDI IN1 to SDI IN8, IN A1, IN A2, IN B1 or IN B2 is displayed in the X part. • The material name (up to 10 characters) is displayed in the *** part. 	FS	Parameter	FS	Mode	Delay		
		Setting range	On, Off	Normal, Dot by Dot, Up Convert, Auto (Only SDI IN5 to SDI IN8 are covered by the "Up Convert" and "Auto" modes.)	0 to 8f (Only SDI IN7 and SDI IN8 are involved here.)		
		Default value	On	SDI IN1 to SDI IN4: Normal	SDI IN5 to SDI IN8: Auto	0f	
	Freeze	Parameter	Select	Freeze			
		Setting range	Frame, Field	On, Off			
		Default value	Frame	Off			
	Name	Parameter	Type	Name			
		Setting range	Default, User				
		Default value	Default				
	Up Converter1	Parameter	Scale	Move Detect	Sharp	Size	
	(SDI IN5 to SDI IN8, IN A1, IN A2, IN B1, and IN B2 only)	Setting range	Squeeze, Edge Crop, Letter Box	1 to 5	1 to 5	100 to 110	
		Default value	Squeeze	3	3	100	
	Up Converter2	Parameter	Edge Crop Pos		Limiter		
	(SDI IN5 to SDI IN8, IN A1, IN A2, IN B1, and IN B2 only)	Setting range	Center, Right, Left		Off, 108, 104, 100 (Only IN A1, IN A2, IN B1 and IN B2 are involved here.)		
		Default value	Center		Off		
	Video Process1	Parameter	Video Process	Y-Gain	Pedestal		
		Setting range	On, Off	0.0 to 200.0	-20.0 to 20.0		
		Default value	Off	100.0	0.0		
	Video Process2	Parameter		C-Gain	Hue	Copy From (↓)	
		Setting range		0.0 to 200.0	0.0 to 359.9	SDI IN1 to SDI IN8	
		Default value		100.0	0.0	Default values vary depending on the selections of the Select items in the Input submenu.*	

*: When the Select item is SDI IN1: SDI IN2
 When the Select item is other than SDI IN1: SDI IN1

5. Setting menu table

Menu	Sub menu		Parameter 1	Parameter 2	Parameter 3	Parameter 4
	Use [F1] to select.		Use [F2] to select.	Use [F3] to select.	Use [F4] to select.	Use [F5] to select.
Input (Analog) / X (***) <ul style="list-style-type: none"> • IN A1, IN A2, IN B1 or IN B2 is displayed in the X part. • The material name (up to 10 characters) is displayed in the *** part. 	FS	Parameter	FS	Mode		
		Setting range	On, Off	Normal, Dot by Dot, Up Convert		
		Default value	On	Normal		
	Freeze	Parameter	Select	Freeze		
		Setting range	Frame, Field	On, Off		
		Default value	Frame	Off		
	Name	Parameter	Type	Name		
		Setting range	Default, User			
		Default value	Default			
	Up Converter1	Parameter	Scale	Move Detect	Sharp	Size
		Setting range	Squeeze, Edge Crop, Letter Box	1 to 5	1 to 5	100 to 110
		Default value	Squeeze	3	3	100
	Up Converter2	Parameter	Edge Crop Pos		Limiter	
		Setting range	Center, Right, Left		Off, 108, 104, 100	
		Default value	Center		Off	
	Video Process	Parameter	Gain			
	Setting range	-30 to 30				
	Default value	0				
Input (DVI) / X (***) <ul style="list-style-type: none"> • DVI IN, IN A1, IN A2, IN B1 or IN B2 is displayed in the X part. • The material name (up to 10 characters) is displayed in the *** part. 	Freeze	Parameter	Select	Freeze		
		Setting range	Frame, Field	On, Off		
		Default value	Frame	Off		
	Name	Parameter	Type	Name		
		Setting range	Default, User			
		Default value	Default			
	DVI Input	Parameter	Mode	Scale		Auto (↓)
		Setting range	Digital, Analog (Enabled when the AV-HS04M3 option board has been connected.)	Fit-V, Fit-H, Full		Black, White (Enabled when the AV-HS04M3 option board has been connected.), Init
		Default value	Digital	Full		Black
	DVI Phase	Parameter	Clk Phs	H-Pos	V-Pos	
	(Enabled when the AV-HS04M3 option board has been connected.)	Setting range	-16 to 15	-100 to 100	-100 to 100	
	Default value	0	0	0		
DVI Status	Display only	Size	Dot Clock	H-Frequency	V-Frequency	
		x	***.***MHz	***.***kHz	***.***Hz	

5. Setting menu table

Menu	Sub menu		Parameter 1	Parameter 2	Parameter 3	Parameter 4
	Use [F1] to select.		Use [F2] to select.	Use [F3] to select.	Use [F4] to select.	Use [F5] to select.
Input (Composite) / X (***) • IN A1, IN A2, IN B1 or IN B2 is displayed in the X part. • The material name (up to 10 characters) is displayed in the *** part.	FS	Parameter	FS	Mode		
		Setting range	On, Off	Dot by Dot, Up Convert (Enabled when the system format is set to 1080/59.94i, 1080/24PsF, 1080/23.98PsF and 720/59.94p.)		
		Default value	On	Up Convert		
	Freeze	Parameter	Select	Freeze		
		Setting range	Frame, Field	On, Off		
		Default value	Frame	Off		
	Name	Parameter	Type	Name		
		Setting range	Default, User			
		Default value	Default			
	Up Converter1	Parameter	Scale	Move Detect	Sharp	Size
		Setting range	Squeeze, Edge Crop, Letter Box	1 to 5	1 to 5	100 to 110
		Default value	Squeeze	3	3	100
	Up Converter2	Parameter	Edge Crop Pos		Limiter	
		Setting range	Center, Right, Left		Off, 108, 104, 100	
		Default value	Center		Off	
	Video Process	Parameter	Gain	Chroma	Ped	Hue
		Setting range	-30 to 30	-8 to 7	-100 to 100	-30 to 30 (Enabled when the system format is set to 1080/59.94i, 720/59.94p and 480/59.94i.)
		Default value	0	0	0	0

5. Setting menu table

Menu	Sub menu	Parameter	Parameter 1	Parameter 2	Parameter 3	Parameter 4
	Use [F1] to select.		Use [F2] to select.	Use [F3] to select.	Use [F4] to select.	Use [F5] to select.
Output	Output	Parameter	Select (↓)			SDI Limit
		Setting range	SDI OUT1 to 5, DVI OUT, OUT-A1, OUT-A2, OUT-B1, OUT-B2			Off, 108, 104, 100
		Default value	SDI OUT1			Off
Output (SDI) / Y SDI OUT1 to SDI OUT5, OUT A1, OUT A2, OUT B1 or OUT B2 is displayed in the Y part. (OUT A1, OUT A2, OUT B1 and OUT B2 take effect when the AV-HS04M7 board has been connected.)	Assign	Parameter	Source	Mode		
		Setting range	PGM, PVW, CLN, AUX1 to 4, MV, KeyOut, MEM-PVW	Normal, Down Convert ("Down Convert" takes effect when AV-HS04M7 is connected.)		
		Default value	PGM(OUT1), PVW(OUT2), AUX1(OUT3), AUX2(OUT4), AUX3(OUT5), AUX1(OUTA1), AUX2(OUTA2), AUX3(OUTB1), AUX4(OUTB2)	Normal		
	Down Converter	Parameter	Scale	Delay	Sharp	
	(Enabled when the AV-HS04M7 option board has been connected.)	Setting range	Squeeze, Edge Crop, Letter Box	90H(75H), 1F	1 to 5	
		Default value	Squeeze	90H(75H)	3	
Output (Analog) / Y OUT A1, OUT A2, OUT B1 or OUT B2 is displayed in the Y part. (OUT A1, OUT A2, OUT B1 and OUT B2 take effect when the AV-HS04M4 board has been connected. OUT A2 and OUT B2 take effect when the AV-HS04M5 board has been connected.)	Assign	Parameter	Source			
		Setting range	PGM, PVW, CLN, AUX1 to 4, MV, Key Out, MEM-PVW			
		Default value	AUX1(OUTA1), AUX2(OUTA2), AUX3(OUTB1), AUX4(OUTB2)			

5. Setting menu table

Menu	Sub menu		Parameter 1	Parameter 2	Parameter 3	Parameter 4
	Use [F1] to select.		Use [F2] to select.	Use [F3] to select.	Use [F4] to select.	Use [F5] to select.
Output (DVI-D) / DVI OUT	Assign	Parameter	Source	Move Detect		
		Setting range	PGM, PVW, CLN, AUX1 to 4, MV, Key Out, MEM-PVW	1 to 5		
		Default value	MV	3		
	DVI Output	Parameter		Size (↓)	Scale	
		Setting range		Auto, XGA, WXGA, SXGA, WSXGA+, UXGA, WUXGA, 1080/59.94i, 1080/59.94p, 720/59.94p, 720/50p, 1080/50p, 1080/50i	Fit-V, Fit-H, Full, Fullx80%, Fullx90%	
		Default value		Auto	Full	
Output (DVI-I) / Y OUT A1 or OUT B1 is displayed in the Y part. (It takes effect when the AV-HS04M5 board has been connected.)	Assign	Parameter	Source	Move Detect		
		Setting range	PGM, PVW, CLN, AUX1 to 4, MV, Key Out, MEM-PVW	1 to 5		
		Default value	AUX1(OUTA1), AUX3(OUTB1)	3		
	DVI Output	Parameter	Mode	Size	Scale	
		Setting range	Digital, Analog	— Analog — Auto, XGA, WXGA, SXGA — Digital — Auto, XGA, WXGA, SXGA, WSXGA+, UXGA, WUXGA	Fit-V, Fit-H, Full, Fullx80%, Fullx90%	
		Default value	Digital	Auto	Full	

5. Setting menu table

Menu	Sub menu	Parameter	Parameter 1	Parameter 2	Parameter 3	Parameter 4
	Use [F1] to select.		Use [F2] to select.	Use [F3] to select.	Use [F4] to select.	Use [F5] to select.
Config	Operate	Parameter	Bus Mode	Key Link	Time Unit	Delegation
		Setting range	A/B, PGM-A/PST-B, PGM-B/PST-A	Off, DSK, PinP1, PinP2, PinP1/2	Sec, Frame	On, Off
		Default value	PGM-A/PST-B	Off	Sec	On
	Assign	Parameter	FTB Source	CLN		
		Setting range	Still1, Still2, Clip1, Clip2, CBGD1, CBGD2, White, Black	Key, DSK		
		Default value	Black	Key		
	Latency	Parameter	BKGD	Key		
		Setting range	1F Fix, Minimum	1F Fix, Minimum		
		Default value	Minimum	Minimum		
	LCD BL	Parameter	Light (↓)	Adjust		
		Setting range	On, Off, 60, 120, 180	80 to 150%		
		Default value	On	100%		
	Button Illumination	Parameter	Illumination	Adjust		
		Setting range	On, Off	80 to 150%		
		Default value	On	100%		
	WFM	Parameter	Style	Mode		
		Setting range	Parade, Overlay	YPbPr, RGB, Y		
		Default value	Parade	YPbPr		
	Vector	Parameter	Bar Target			
		Setting range	75%, 100%			
		Default value	100%			
	User Button1	Parameter	User1	User2	User3	User4
		Setting range	KEY PVW, PinP PVW, PinP1PVW, PinP2PVW, DSK PVW, GPII-EN, GPIO-EN, SHIFT, AUX Trans, PinP Trans, EFF DSLV, None			
		Default value	KEY PVW	PinP PVW	DSK PVW	PinP Trans
	User Button2	Parameter	User5	User6	User7	User8
		Setting range	The setting range is the same as for the User Button1 sub menu.			
		Default value	AUX Trans	EFF DSLV	SHIFT	None

5. Setting menu table

Menu	Sub menu		Parameter 1	Parameter 2	Parameter 3	Parameter 4
	Use [F1] to select.		Use [F2] to select.	Use [F3] to select.	Use [F4] to select.	Use [F5] to select.
Config	GPI-In Setting	Parameter	GPI-In Enable	AUX Sel		
		Setting range	On, Off	AUX1 to 4		
		Default value	On	AUX1		
	GPI-In Port 1/2	Parameter	Port1Assign	Port2Assign	Port3Assign	Port4Assign
		Setting range	AUTO, CUT, KEY ON, DSK ON, PinP1 ON, PinP2 ON, FTB, BKGD AUTO, BKGD CUT, KEY AUTO, KEY CUT, REC Still1, REC Still2, REC Clip1, PLAY Clip1, STOP Clip1, REC Clip2, PLAY Clip2, STOP Clip2, AUX XPT1 to 24, RED Tly DSBL, GRN Tly DSBL, AUX Tly DSBL, No Assign			
		Default value	No Assign	No Assign	No Assign	No Assign
	GPI-In Port 2/2	Parameter	Port5Assign	Port6Assign	Port7Assign	Port8Assign
		Setting range	The setting range is the same as for the GPI-In Port 1/2 sub menu.			
		Default value	No Assign	No Assign	No Assign	No Assign
	GPI-Out Setting	Parameter	GPI-Out Enable	AUX Tly Sel		
		Setting range	On, Off	AUX1 to 4		
		Default value	On	AUX1		
	GPI-Out Port 1/5	Parameter	Port1Assign	Port2Assign	Port3Assign	Port4Assign
		Setting range	AUTO, CUT, KEY ON, DSK ON, PinP1 ON, PinP2 ON, FTB ON, BKGD AUTO, BKGD CUT, KEY AUTO, KEY CUT, KEY Trans, DSK Trans, PinP1Trans, PinP2Trans, FTB Trans, RED Tly1 to 13, GRN Tly1 to 13, AUX Tly1 to 13, Event MEM, No Assign			
		Default value	No Assign	No Assign	No Assign	No Assign
	GPI-Out Port 2/5	Parameter	Port5Assign	Port6Assign	Port7Assign	Port8Assign
		Setting range	The setting range is the same as for the GPI-Out Port 1/5 sub menu.			
		Default value	No Assign	No Assign	No Assign	No Assign
	GPI-Out Port 3/5	Parameter	Port9Assign	Port10Assign	Port11Assign	Port12Assign
		Setting range	The setting range is the same as for the GPI-Out Port 1/5 sub menu.			
		Default value	No Assign	No Assign	No Assign	No Assign
	GPI-Out Port 4/5	Parameter	Port13Assign	Port14Assign	Port15Assign	Port16Assign
		Setting range	The setting range is the same as for the GPI-Out Port 1/5 sub menu.			
		Default value	No Assign	No Assign	No Assign	No Assign
	GPI-Out Port 5/5	Parameter	Port17Assign	Port18Assign	Port19Assign	
		Setting range	The setting range is the same as for the GPI-Out Port 1/5 sub menu.			
		Default value	No Assign	No Assign	No Assign	
	COM-Port	Parameter	Mode (↓)			
		Setting range	1 to 3			
		Default value	1			
System Menu	Parameter	Lock				
	Setting range	On, Off				
	Default value	Off				

5. Setting menu table

Menu	Sub menu		Parameter 1	Parameter 2	Parameter 3	Parameter 4
	Use [F1] to select.		Use [F2] to select.	Use [F3] to select.	Use [F4] to select.	Use [F5] to select.
System /Locked (When locked)	(Message)	Display only	System menu is locked			
System /Unlocked (When unlocked)	Format	Parameter	Format (↓)	Hi Resolution	16:9 Squeeze	
		Setting range	1080/59.94i, 1080/50i, 1080/24PsF, 1080/23.98PsF, 720/59.94p, 720/50p, 480/59.94i, 576/50i	On, Off (Selection enabled when SD format is used)	On, Off (Selection enabled when SD format is used)	
		Default value	1080/59.94i	Off	Off	
	Output Phase	Parameter	System	H-Phase	V-Phase	
		Setting range	0H, 1H	The setting range differs from one format to another. 1080/59.94i: -1100 to 1099 1080/50i: -1320 to 1319 1080/24PsF: -1375 to 1374 1080/23.98PsF: -1375 to 1374 720/59.94p: -825 to 824 720/50p: -990 to 989 480/59.94i: -429 to 428 576/50i: -432 to 431	-100 to 100	
		Default value	0H	0	0	
	Reference	Parameter	Sync (↓)	BB Setup	Gen Lock	
		Setting range	BB, BB Advanced, Tri-level sync, Internal	0IRE, 7.5IRE	Locked, UnLock	
		Default value	BB	7.5IRE	UnLock	
	Ancillary	Parameter	AUX	PGM	PVW	MV
		Setting range	On, Off	On, Off	On, Off	PGM, PVW, Off
		Default value	Off	Off	Off	Off
	Alarm	Parameter	Power	Fan	Temperature	
		Display only	Alarm, No Alarm	Alarm, No Alarm	Alarm, No Alarm	
	Initial	Parameter	Initial (↓)	Fader Initial		
		Setting range	Mode A, Mode B	Execute		
		Default value	Mode A			

5. Setting menu table

Menu	Sub menu	Parameter	Parameter 1	Parameter 2	Parameter 3	Parameter 4
	Use [F1] to select.		Use [F2] to select.	Use [F3] to select.	Use [F4] to select.	Use [F5] to select.
System /Unlocked (When unlocked)	Network1	Parameter	IP Address			
		Setting range	0 to 255			
		Default value	192.168.0.8			
	Network2	Parameter	Subnet Mask			
		Setting range	0 to 255			
		Default value	255.255.255.0			
	Network3	Parameter	Default Gateway			
		Setting range	0 to 255			
		Default value	192.168.0.1			
	Network4	Parameter	MAC Address			
		Display only	Display only			
	Date	Parameter	Year	Month	Date	Set
		Setting range	2011 to 2035	1 to 12	1 to 31	Execute
		Default value	-	-	-	
	Time	Parameter	Hour	Minute	Second	Set
		Setting range	0 to 23	0 to 59	0 to 59	Execute
		Default value	-	-	-	
	Main Version	Parameter	System Version	Module Type	Select	Version
		Setting range	Version number	Soft, FPGA	— Soft — Main1, Main2, BKGD, KEY, PinP, DSK, TIME, Plugin, VMEM, Memory, XPT/MV, Input, Output, Config, System, BKGDPat, XPTStat, HsifLibrary	Version number
		Default value		Soft	Main1	
	Option Version	Parameter	Select	Board	Version	
		Setting range	SLOT A, SLOT B	SDI-IN, Ana-IN, DVI-IN, DVID-IN, SDI-OUT, Ana-OUT, D/A-OUT, Csit-IN, None	Version number	
		Default value	SLOT A			

Appendix (glossary)

Defined below are the terms used in this manual.

Word	Explanation
AB Bus system	A bus control mode. By executing a transition, the A bus and B bus signals are output to the program images alternately.
Ancillary Data	The auxiliary data other than the video signals which is transmitted inside the data stream of the video serial interface. The data superimposed on the vertical blanking period is referred to as the V ancillary data (VANC).
Aspect ratio	The ratio between the horizontal and vertical dimensions of an image or screen. It is 16:9 for the HD format and 4:3 for the SD format.
AUX [Auxiliary Bus]	A spare bus which can be switched by signals other than the main line output signals.
AVDL [Automatic Video Delay Line]	A function to automatically adjust the input image signal phase to the horizontal synchronization reference signal phase.
BB [Black burst]	The black burst signal. A full-screen black level composite signal which is used as the reference signal for gen-lock.
Border	The area or margin that is added to the edge of a wipe or key. Its width and color can be adjusted. The defocusing of the area around a border is referred to as the soft effect.
Chroma key	This refers to the function for creating the key signals based on the color information of the video signals and combining the keys.
Clip	The threshold level of the luminance when key signals are created from a key source.
Color Background	The signals which are output from the internal color generator and used as the background image.
Cut	This refers to the effect where the display is instantly switched to the next image.
Density	A parameter which is used to adjust the density of the key signals.
Dot by Dot	This treats images as actual size (1×) images. With PinP, it allows SD images to be combined with HD images with no accompanying deterioration in the images themselves.
Down Converter	This is the function that converts material in the HD format into the SD format.
DSK [Downstream Key]	This refers to the key combination process which is performed at the end of the mix effect. The key is always combined with the foremost image.
DVE [Digital Video Effect]	This refers to the transition patterns accompanying size reductions or slide effects.
DVI [Digital Visual Interface]	A digital video interface standard. DVI-I can handle both digital signals and analog signals.
Embedded Audio	This refers to the audio data packets which are transferred inside the data stream of the video serial interface.
Flip Flop system (PGM/PST system)	A bus control mode. The signals selected by the program bus are always output as the program images. By executing a transition, the program bus and preset bus signals are switched over.
Flying Key	This function uses DVE effects to move, expand or reduce key signals.
Frame Synchronizer	A function which matches the synchronization of non-synchronized video input signals.
Freeze	A function which continues the display of the same image, creating the impression that the image has been "frozen".
FTB [Fade to Black]	This is the effect where the background image is faded out to the black screen.
Genlock	A function for synchronizing the video signals using an external sync signal as the reference.

Appendix (glossary)

Word	Explanation
GPI [General Purpose Interface]	Interface signals which control auto transition from an external source.
Hue	The color tone of the video signals.
IRE	A unit used for video signal levels. The setup level (black level) of the signals is expressed as 0 IRE, 7.5 IRE, etc.
Key Edge	The border or shadow added to the edges of keys.
Key Fill	The signal that uses key combination processing to fill in the areas left blank by the key signals.
Key Gain	A parameter which is used to adjust the amplitude of the key signals.
Key Invert	A function which inverts the key signals.
Key Mask	This is the function that specifies the area for key combination using the box pattern, etc. When only part of the area of the key signals is used, key combination is executed with the unnecessary area masked.
Key Source	The video signals for creating the key signals.
Linear Key	The function which combines keys using monochrome key signals with gradations in its outlines as a reference.
Lum [Luminance]	The brightness portion of the video signals.
Luminance Key	The function which creates key signals based on the luminance (brightness) information of the video signals to combine keys.
ME [Mix Effect]	A video effect device which combines a number of video signals to create mix, wipe, key and other video signals.
Mix	The picture-changing effect produced by overlapping one image with the next. It is also referred to as "dissolve".
Multi View Display	This function combines multiple materials and displays them on one screen. PGM, PVW and the input material can be previewed at the same time on a single screen.
OSD [On Screen Display]	This function enables settings to be performed on the menu screens which are displayed in the monitor output.
PinP [Picture in Picture]	This function combines a sub screen image with the background image.
PVW [Preview]	The function for checking ahead of time the image which will be output after the next transition. The image is output from the PVW system.
PGM [Program Bus]	The bus which always carries the program output signals.
PST [Preset Bus]	The bus which carries the program output signals after the next background transition.
RS-422	A serial interface standard. It is the interface used to control the switcher from an editor or other external device.
Sat [Saturation]	This refers to the intensity of the color chrominance level of video signals.
SDI [Serial Digital Interface]	The standard by which video signals in various SD and HD formats are transmitted along a single coaxial cable.
Self Key	A function that creates key signals from key fill signals for combining keys.
Setup Data	The memory in which the control panel statuses can be saved and recalled. The button selection statuses as well as the border, color and other setting information can be saved in this memory.

Appendix (glossary)

Word	Explanation
Tally	The signal which outputs the program output statuses of the input signals to an external device. The LED that indicates the program output status on the control panel is also referred to as tally.
Transition	A function that switches from one image to another. Wipe, mix and other effects are available for the images during switching.
Tri-level Sync	The sync signal used for HD formats.
Trimming	This is the function that eliminates the unnecessary parts at the top, bottom, left and/or right of the images which are combined using the PinP function.
Up Converter	This is the function that converts material in the SD format into the HD format which yields a high resolution.
Video Memory	This is the memory in which the images (still images and moving images) with key signals can be stored.
Wipe	A video effect in which one image is gradually replaced by another as the boundary between the two is moved using a preselected pattern.

Index

B		D	
Menu Background	117	Menu DSK	123
3D Modify	117	Adjust	123
Border	117	DSK	123
Border Color	117	Edge1	123
Modify	117	Edge2	123
SQ Position	117	Edge Color	123
WIPE Position	117	Fill Matt	123
		Mask	123
		Mask Adjust	123
C		E	
Menu Chroma Key	120	Menu Event Memory	127
Adjust	120	Event Duration	127
Auto Compute	120	Mark	127
FineTuning	120	MEM PVW	127
Sample	120	Path	127
Menu Color Background	118	Recall Select	127
CBGD1 Main	118	Register	127
CBGD1 Move	118	Run	127
CBGD1 Sub	118	Store Select	127
CBGD1 Wash	118	Timeline	127
CBGD1 Wave	118	Total Duration	127
CBGD2 Main	118	XPT Disable	127
CBGD2 Move	118		
CBGD2 Sub	118		
CBGD2 Wash	118		
CBGD2 Wave	118		
Menu Config	135	I	
Assign	135	Menu Input	130
Button Illumination	135	Input	130
COM-Port	136	Menu Input (Analog)	131
GPI-In Port 1/2	136	Freeze	131
GPI-In Port 2/2	136	FS	131
GPI-In Setting	136	Name	131
GPI-Out Port 1/5	136	Up Converter1	131
GPI-Out Port 2/5	136	Up Converter2	131
GPI-Out Port 3/5	136	Video Process	131
GPI-Out Port 4/5	136	Menu Input (Composite)	132
GPI-Out Port 5/5	136	Freeze	132
GPI-Out Setting	136	FS	132
Latency	135	Name	132
LCD BL	135	Up Converter1	132
Operate	135	Up Converter2	132
System Menu	136	Video Process	132
User Button1	135	Menu Input (DVI)	131
User Button2	135	DVI Input	131
Vector	135	DVI Phase	131
WFM	135	DVI Status	131
		Freeze	131
		Name	131

Index

Menu Input (SDI)	130
Freeze	130
FS	130
Name	130
Up Converter1	130
Up Converter2	130
Video Process1	130
Video Process2	130

K

Menu Key	119
3D Modify	119
Adjust	119
Edge1	119
Edge2	119
Edge Color	119
Fill Matte	119
Flying Key	119
Key	119
Key Priority	120
Mask	120
Mask Adjust	120
SQ Position	119
Transition	119
WIPE Position	119

M

Menu Multi View Display	129
Display	129
MV Frame	129
MV Pattern 1/4	129
MV Pattern 2/4	129
MV Pattern 3/4	129
MV Pattern 4/4	129
MV Split	129

O

Menu Output	133
Output	133
Menu Output (Analog)	133
Assign	133
Menu Output (DVI-D)	134
Assign	134
DVI Output	134
Menu Output (DVI-I)	134
Assign	134
DVI Output	134
Menu Output (SDI)	133
Assign	133
Down Converter	133

P

Menu PinP1	121
Border	121
Border Color	121
PinP	121
Position	121
Sync	121
Trim	121
Trim Adjust	121

Menu PinP2	122
Border	122
Border Color	122
PinP	122
Position	122
Sync	122
Trim	122
Trim Adjust	122

Menu Plug-in	124
---------------------------	------------

S

Menu SD Card	126
Card Information	126
File1	126
File2	126

Menu Shot Memory	126
MEM PVW	126
Path	126
Recall Select	126
Register	126
Store Select	126
XPT Disable	126

Menu System	137
Alarm	137
Ancillary	137
Date	138
Format	137
Initial	137
Main Version	138
Network1	138
Network2	138
Network3	138
Network4	138
Option Version	138
Output Phase	137
Reference	137
Time	138

Index

T

Menu Time	124
AUX1 BUS Trans	124
BKGD	124
DSK	124
Effect Dissolve	124
FTB	124
Key	124
PinP1	124
PinP1 BUS Trans	124
PinP2	124
PinP2 BUS Trans	124

V

Menu Video Memory	125
Clip1 Play Mode	125
Clip2 Play Mode	125
Memory	125
Rec1	125
Rec2	125
Trans Sync	125
Video Memory1	125
Video Memory2	125
Video Memory3	125

X

Menu XPT	128
XPT Assign 1/6	128
XPT Assign 2/6	128
XPT Assign 3/6	128
XPT Assign 4/6	128
XPT Assign 5/6	128
XPT Assign 6/6	128
XPT Setting	128
XPT Switch	128

Memo

A series of horizontal dashed lines for writing.

